



Artemide[®]
ARCHITECTURAL

Artemide. Collections

With 3 product lines, Artemide offers a complete range of lighting equipment. These can be integrated to resolve the lighting engineering needs with all types of application, both indoor and outdoor.



Artemide Design



Artemide Architectural



Danese Environmental Light



Artemide Lighting Fields

Indoor

146	37 Cube	508	Nota Bene
572	Absolu	268	Nothing downlight
298	Algoritmo	358	Nothing 86
62	Airlite	554	Ourea 156
594	Bolero	156	PAD
30	Cata	174	PAD 80
110	Caelum	410	PAD System
446	Chocolate	244	Parabola
396	Eggboard	608	Pixel Mesh
460	Esprit	82	Picto
190	Everything	258	Rastaf
436	Gradian	586	Solar
418	Grafa	604	Starled
288	Hide	468	Surf
390	Incipit	520	Tagora
132	Java	502	Talo
274	Java downlight	264	Toplite
480	Kalifa	106	Tracks
596	Kalifa recessed	584	Tray
576	Kao	568	Twist
216	Luceri	442	Uglare19
600	Leb	278	Zeno UP
560	Mouette	284	Zeno Up Frosted

Outdoor

790	Aglaia	844	Indicta
738	Aria	816	Ippolito
788	Basolo	644	Label Light
764	Calumet	632	LineaLed
790	Catilina	818	Logico Garden
678	Cariddi	726	Megara
854	Cariddi pole	734	Microled
682	Cefiso	656	Minispot
850	Cefiso pole	782	Mitasi
804	Chilone	768	Molla
798	Ciclope	774	Niki
784	Cuneo	792	Nuda
652	Dedalo	674	Obice
616	Diamante	770	Pantarei
778	Dioscuri	752	Percorso
758	Effetto	822	Piroscafo
690	Ego downlight	838	Poto
658	Ego spot	856	Provoca
710	Ego walk/drive over	828	Reeds
664	Epulo	648	Riga
814	Eraclea	620	Spike
742	Faci	860	Solar Tree
670	Falange	848	Sostituto pole
824	Granito	680	Sostituto spot
840	Hila	628	Superspike
790	Illo	810	Tetragono
		834	Tolomeo XXL

Indoor typological index

CEILING



30
Cata



390
Incipt



600
Leb



30
Cata



436
Gradian

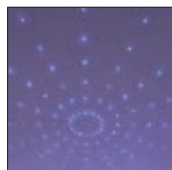

604
Starled



156
PAD

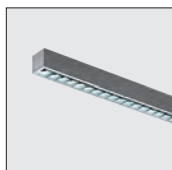

480
Kalifa



82
Picto

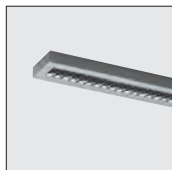

508
Nota Bene



62
Airlite

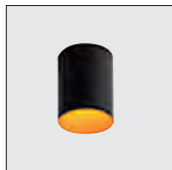

520
Tagora

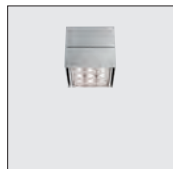

174
PAD 80



554
Ourea 156



298
Algoritmo

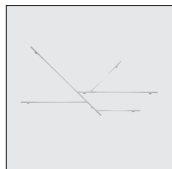

576
Kao

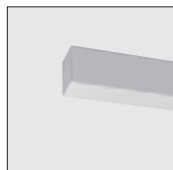

358
Nothing 86



584
Tray

CEILING RECESSED - SEMI RECESSED



146
37 Cube



244
Parabola



298
Algoritmo



156
PAD



258
Rastaf



442
Uglare19



62
Airlite



264
Toplite

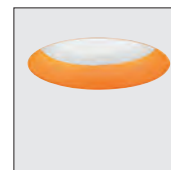

520
Tagora



110
Caelum



268
Nothing downlight



586
Solar



132
Java



274
Java downlight



594
Bolero



174
PAD 80

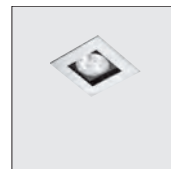

278
Zeno Up



596
Kalifa recessed



190
Everything



284
Zeno Up Frosted



600
Leb



216
Luceri



288
Hide

TRACK



30
Cata



156
PAD



82
Picto



62
Airlite



106
Tracks

SUSPENSION



30
Cata



62
Airlite



298
Algoritmo

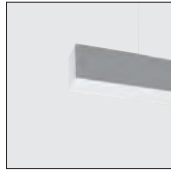

358
Nothing 86



390
Incipit



396
Eggboard



410
Pad System

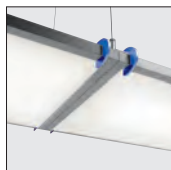

418
Grafa

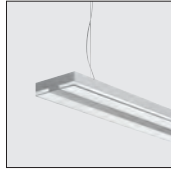

456
Chocolate

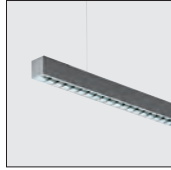

480
Kalifa



502
Talo



508
Nota Bene



460
Esprit



468
Surf



520
Tagora



554
Ourea 156

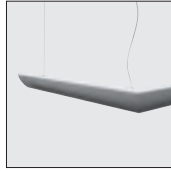

560
Mouette



568
Twist

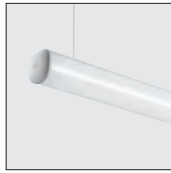

572
Absolu

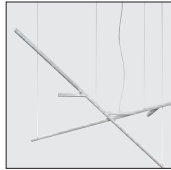

576
Kao



584
Tray

WALL

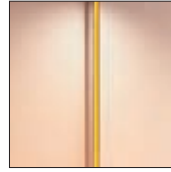

298
Algoritmo

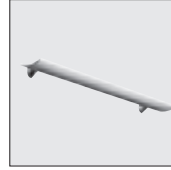

468
Surf

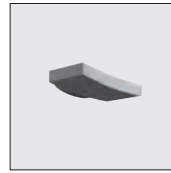

476
Surf wall



458
Chocolate wall

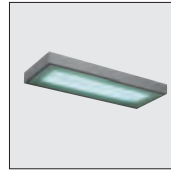

498
Kalifa wall

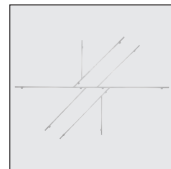

576
Kao



600
Leb

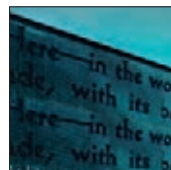

608
Pixel Mesh

FLOOR



446
Chocolate



480
Kalifa

Outdoor typological index

SUSPENSION

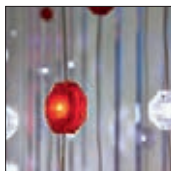

616
Diamante

LINEAR PROFILE



620
Spike



628
Super Spike



644
Label Light



648
Riga

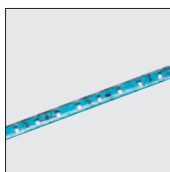

652
Dedalo

WALL - CEILING



770
Pantarei



774
Niki



778
Dioscuri



782
Mitasi



790
Illo



788
Basolo

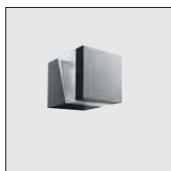

810
Tetragono

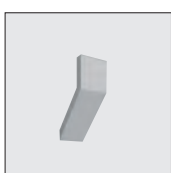

804
Chilone



798
Ciclope

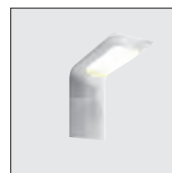

840
Hila

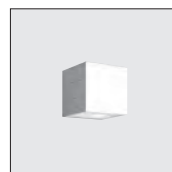

758
Effetto



764
Calumet



768
Molla



784
Cuneo



674
Obice



658
Ego Spot



664
Epulo



670
Falange



682
Cefiso



680
Sostituto Spot



678
Cariddi



856
Provoca wall

WALL RECESSED

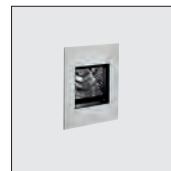

738
Aria

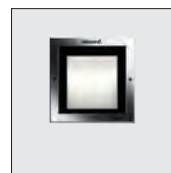

742
Faci

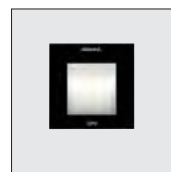

746
Faci Vetro



752
Percorso



792
Nuda



798
Ciclope

CEILING RECESSED

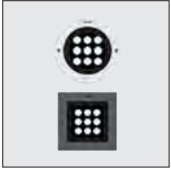

690
Ego downlight

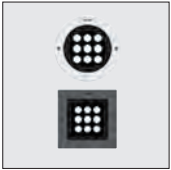

690
Ego Flat downlight

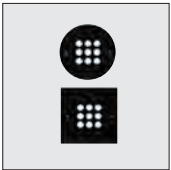

706
Ego Vetro downlight



738
Aria

GROUND RECESSED

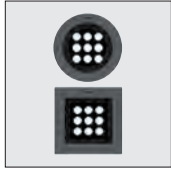

710
Ego drive/walk-over

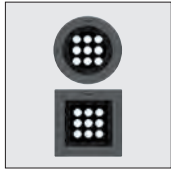

710
Ego Flat walk-over

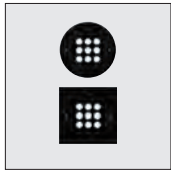

722
Ego Vetro walk-over



734
Microled



626
Spike Incasso

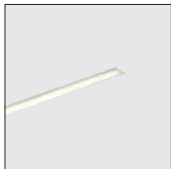

632
LineaLed drive-over



638
LineaLed WW drive-over



726
Megara

FLOOR - BOLLARD



656
Minispot



792
Nuda



818
Logico Garden



814
Eraclea



816
Ippolito



810
Tetragono



828
Reeds



822
Piroscrafo



790
Catalina



790
Aglaiia



804
Chilone



798
Ciclope



824
Granito



658
Ego Spot



664
Epulo



670
Falange



682
Cefiso



680
Sostituto spot



678
Cariddi



834
Tolomeo XXL

POLE



838
Poto

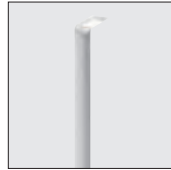

840
Hila



844
Indicta



848
Sostituto pole



850
Cefiso pole



854
Cariddi pole



856
Provoca

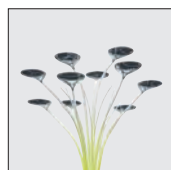

860
Solar Tree

Indoor light performance index

PROJECTOR

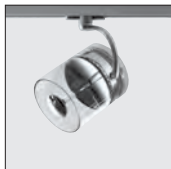

30
Cata



156
PAD



82
Picto



62
Airlite



110
Caelum



132
Java

DOWNLIGHTING



174
PAD



274
Java downlight

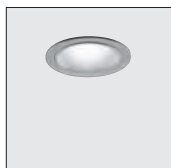

190
Everything



278
Zeno Up



216
Luceri Led

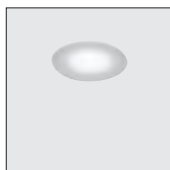

284
Zeno Up Frosted



238
Luceri Fluo



288
Hide



244
Parabola



258
Rastaf



264
Toplite



268
Nothing downlight

PROFESSIONAL LIGHTING



298
Algoritmo



446
Chocolate floor



358
Nothing 86

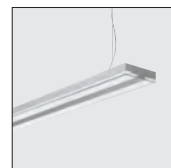

456
Choccolate



390
Incipit

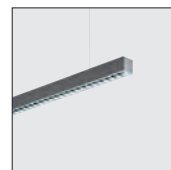

490
Kalifa



396
Eggboard



480
Kalifa floor



410
Pad System



460
Esprit



418
Grafa



468
Surf

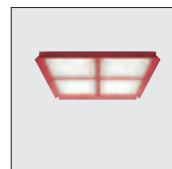

436
Gradian

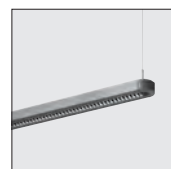

502
Talo



442
Ugliare19



508
Nota Bene

GENERAL LIGHTING



520
Tagora



594
Bolero



554
Ourea 156

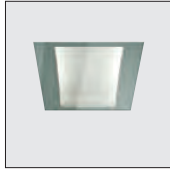

596
Kalifa recessed

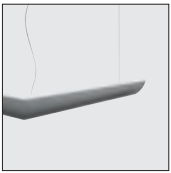

560
Mouette



568
Twist



572
Absolu

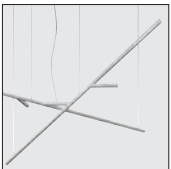

576
Kao



584
Tray



586
Solar

SIGNAL LIGHTING



600
Leb

SCENOGRAPHIC LIGHTING



608
Pixel Mesh

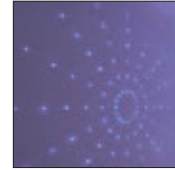

604
Starled

Outdoor light performance index

SCENOGRAPHIC LIGHTING



620
Spike

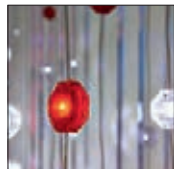

616
Diamante



628
Super Spike

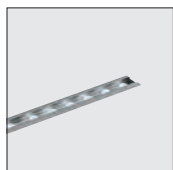

626
Spike incasso



632
LineaLed drive-over

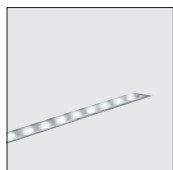

638
LineaLed WW drive-over

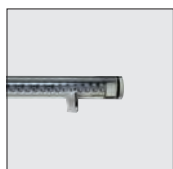

644
Label Light



648
Riga

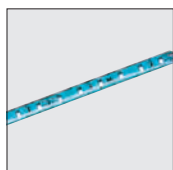

652
Dedalo

ACCENT LIGHTING



656
Minispot



674
Obice



658
Ego spot



664
Epulo



670
Falange



682
Cefiso



680
Sostituto Spot



678
Cariddi

GRAPHIC LIGHTING



764
Calumet

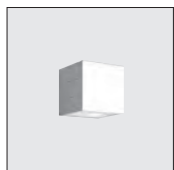

758
Effetto

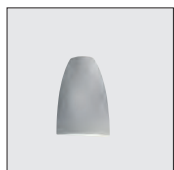

768
Molla



784
Cuneo



788
Basolo



824
Granito

INDICATOR LIGHTING



738
Aria

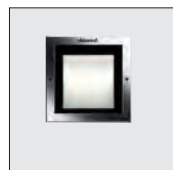

742
Faci

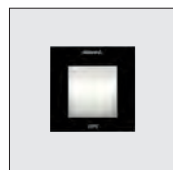

746
Faci Vetro



752
Percorso

DOWNLIGHTING

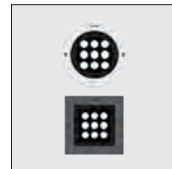

690
Ego downlight

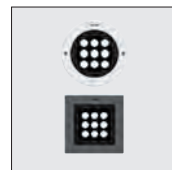

690
Ego Flat downlight

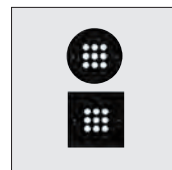

706
Ego Vetro downlight

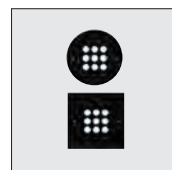

706
Ego Vetro Flat downlight



738
Aria

WALK / DRIVE-OVER LIGHTING

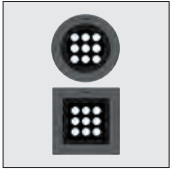

710
Ego drive-over

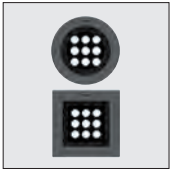

710
Ego Flat walk-over

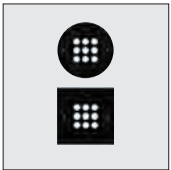

722
Ego Vetro walk-over

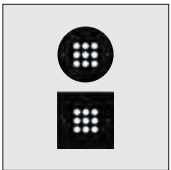

722
Ego Vetro Flat walk-over



726
Megara



734
Microled

GENERAL LIGHTING



770
Pantarei



774
Niki



778
Dioscuri



782
Mitasi



790
Ilo

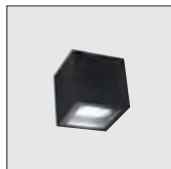

788
Basolo

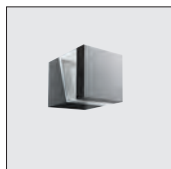

810
Tetragono

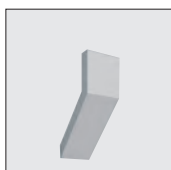

804
Chilone



798
Ciclope



840
Hila

PATH LIGHTING



792
Nuda



818
Logico Garden



814
Eraclea



816
Ippolito



810
Tetragono



828
Reeds



822
Piroascafo



790
Catilina



790
Aglia



804
Chilone



798
Ciclope



838
Poto

PLACES AND STREET LIGHTING



850
Cefiso pole



848
Sostituto pole



840
Hila



844
Indicta



856
Provoca



854
Cariddi pole

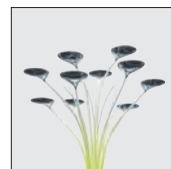

860
Solar Tree



834
Tolomeo XXL

Artemide. The Human Light

ADV Campaign, 1998

Light is a daily presence in our lives.

The relationship between people, light and the environment has always been central to Artemide vision and has been developed over the years. The research subjects range from the individuals' well-being and perception of spaces, to tackling the issues associated with environmental sustainability.

The Human Light is a light able to follow the individuals' flow of behaviours and emotions. It is designed to help achieving psychological well-being and offering new qualities, emotions and awareness to our lives while developing an innovative and responsible vision of the future.

With The Human Light, light becomes a mouldable raw material, an active tool to support the Self, a way of resuming motivations and sensations. Self-awareness in the relationship between people and light must be interpreted not only as flexible management of light within reach, but above all as a priority in the design process.

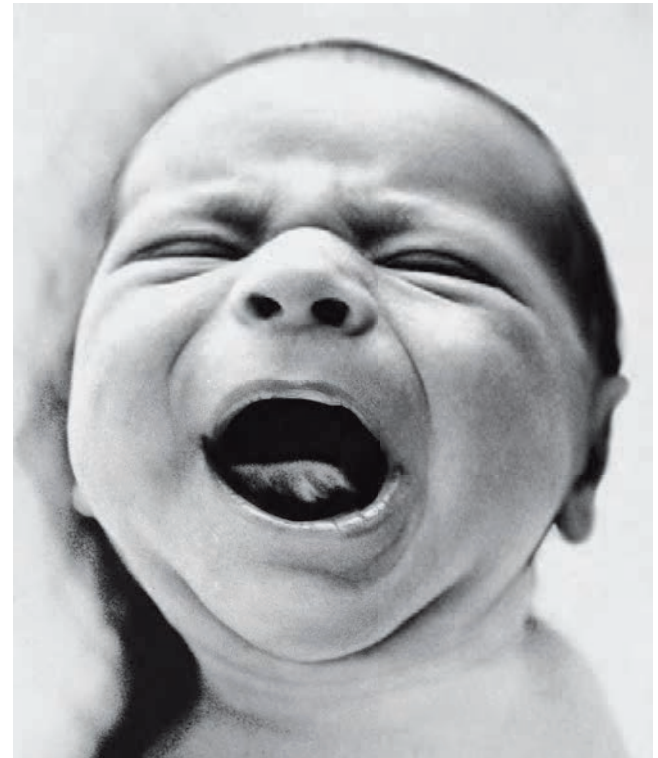

Life will be better with the right light

Artemide
THE HUMAN LIGHT.

Artemide. The Responsible Light

Artemide's research activity is constantly committed to developing and adopting lighting systems that pursue the objective of maximum energy efficiency. All project choices focus on a sole objective: to improve people's quality of life and their relationship with the environment. In the sphere of a policy of the reduction of energy consumption and being ahead of the regulatory requirements, there are four areas of action into which Artemide's commitment is specifically translated:

Eco-Effectiveness

Maximum attention is given to design and manufacturing processes: responsible use of resources, thorough choice of processes and technologies with a view to achieving energy balance.

Long term

Designing thinking to the long term through a careful planning of the entire product life cycle, promoting internal technical training using the experience accrued in sustainability research (LCA, analysis of technologies, of processes, etc.) developed with university research centres.

Responsible Consumption

Spreading culture and offer tools for an informed choice (TCO, LENI) and a rational use of light in terms of energy saving and affordability.

Quality

Quality is an essential choice for a more lasting relationship with the product and a crucial requirement in the search for authentic environmental innovation.

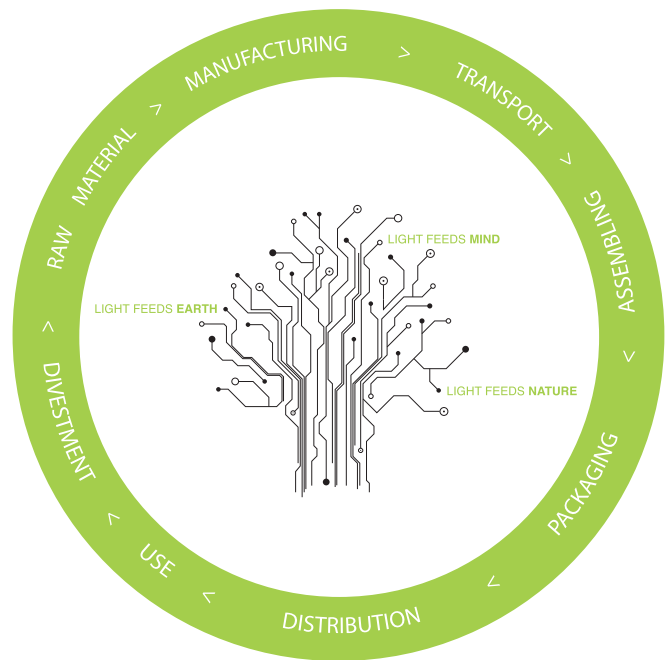

LCA (Life Cycle Assessment)

LCA is a strategic approach used to assess the potential environmental impact of a product during all stages of its life cycle: selection of raw materials, processing, transport and assembly, packaging, distribution, usage, disposal and recycling.

Artemide. The Innovation

We find ourselves at a time when the evolution of technology offers interesting opportunities for the development of generations of conceptually new products. Nevertheless, in the field of light today technological progress is no longer accessible to everyone; it is more complex and requires skilful interpreters: the designer's creativity must necessarily be measured against that of a specialist team. For this reason, over the years Artemide has equipped itself with a research and development structure where there is space for the most diverse and specialist technical expertise, accredited laboratories and certified quality systems.

On one hand, innovation is delivered in the use of LEDs and energy-saving light sources, by using materials and innovative production techniques with attention devoted to efficiency and the quality of the performance. On the other hand, research and technological innovation are understood in a humanistic sense with the aim of continually making a contribution towards the quality of life for people and the planet. Artemide's project is both research and culture, starting from the gathering of constant technological innovation and a cultural approach.

The numerous patents for inventions that accompany the development of Artemide's products and the international awards in the field of innovation and sustainability are testament to the persistence of their projects for the future. Innovation is made of people, of their culture and skills, but above all it comes from continuous experimentation and from a shared vision. It is also with a view to this, that the project has been put in place for a new Campus and Laboratory of thought. This building is in the construction phase and can also be seen as a expression of the efforts and the desire of a company to grow according to a holistic and multi-disciplinary approach, pursuing the principles of sustainability and energy efficiency, with the emphasis on research and experimentation.

1 . CATA

Innovation Patent n. MI2012A000605

The Projector based on LED technology is developed on the optical catadioptric principle with double collimating mirrors and light guiding system.

2 . PAD

Innovation Patent n. MI2010A000609

The Projector is based on LED technology with a system that integrates both optical and electronics. It integrates the active special power supply together with the optical system. The projector uses a thermal conductive back in heat exchange function and also uses a diffuser with integrated light emission lenses.

3 . ALGORITMO SYSTEM CONTROLLED EMISSION

Innovation Patent n. MI2013A001711

Algoritmo controlled emission is patented by Artemide and is the smallest lighting fixture conform to UGR and luminance. A dedicated optical system made by a grid and an array lens produces a controlled emission with UGR < 19 and luminance < 3000 cd/m² @ 65° and over.

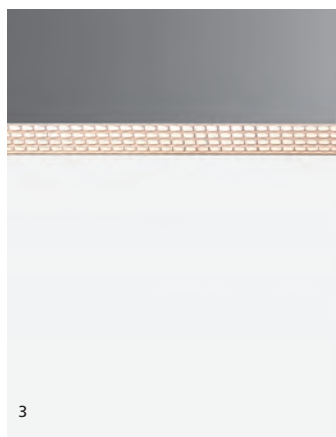

Artemide. The Good Light

By changing colour or temperature, light builds emotions and relationships.

The light radiations reaching our eyes are transformed into electric impulses and transmitted to the brain via the optic nerve. From here a series of inputs are originated and transmitted to the entire body. In particular, when the impulses reach the hypothalamus they determine an increase in serotonin, a neurotransmitter that controls moods. When the impulses reach the epiphysis we have a reduction in melatonin, a hormone sensitive to the day-night cycle. The consequence of these neuro-physiological reactions is a significant mood swing depending on the quantity and quality of light to which an individual is exposed.

Designing light for people means outreaching the purely functional aspects of lighting and embracing a broader dimension, with a new attention towards perceptive experience. Artemide's knowledge and awareness on this topic led to the implementation of innovative lighting systems. This is associated with the research developed from the 1990s to the present day with universities, research centres and experts in various scientific disciplines (medicine, biology, psychology, anthropology).

Metamorfosi, A.I.S.O. and Tunable White combine technological innovation and attention to people and their psychological needs. They are not products, but ways of creating tunable light settings in order to experience the relationship with light through a conscious and direct interaction.

Psychological light



Physiological light

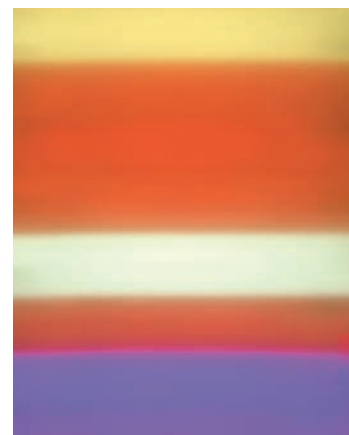

5 YEARS

WARRANTY

Artemide®

Artemide has always provided high quality products. As a result, we are glad to inform you that from April 1st 2015 we will offer to all our end users world-wide (private consumers only) a free 5-year extended warranty, valid only if the product is successfully registered online within two months from the date of purchase.

Conditions for the 5-year extended warranty are as follows:

- Being an end user (private consumer);
- Purchasing the ARTEMIDE product after April 1st 2015;
- Registering the product online within 2 months from the date of purchase;
- The product must be new (not second-hand);
- Being the first owner of the product (the warranty is not transferable).

Following successful online activation and claim, the extended warranty will entitle the private customer to a free repair or replacement when the product is determined to be faulty due to manufacturing defect, as stated on its terms and conditions.

ArtemideTCO[®]

Artemide develops lighting solutions that integrate architectural and living spaces, always with a keen eye on sustainability, sharing expertise and knowledge with architects and lighting planners.

Artemide is sensitive not only to the needs of human beings, but also to the environment, offering a new service aimed at energy saving and to help in reducing costs.

This service is called **Artemide TCO - Total Cost Ownership** and it is one of the latest generation calculation tools. Beginning from precise estimates of installation and usage costs, it offers solutions for controlling equipment and installations that require a targeted consumption of energy.

With its 55 **Lighting Consultancy Centres** worldwide, Artemide offers customers a complete service to support lighting engineering plans, beginning a constant dialogue with its partners.

It is also possible to download the Dialux and Luxart calculation programs, Eulumdat data, 2D and 3D images of products from the **artemide.com** website, together with all the technical information necessary to implement your own independent lighting engineering project.

Artemide TCO is a professional tool for the implementation of energy performance and economic evaluations of your lighting projects.

1_Project

Enter general information (town, building type, etc.) adding qualitative details such as how the area is occupied and the supply of natural daylight.

2_Solution

Create two or more simple alternative project solutions while defining suitable manual or automatic control systems, such as presence detectors and light sensors, for each fixture.

3_Energy

Artemide TCO compares alternative solutions, clearly displaying thorough energy results compliant to EN 15193 standards, CO2 emissions and energy saving percentages.

4_TCO

Artemide TCO compares alternative lighting solutions also through intuitive charts and graphs, displaying TCO details and ROI spread over time.

5_Report

Finally, you can generate and export a .pdf recap project report which can be customized with your logo, details and a selection of the energy performance and economic information you would like to highlight.

$$TCO = \text{€}_{\text{system}} + \text{€}_{\text{maintenance}} + (W_{l,t} + W_{p,t}) \cdot \text{€}_{\text{kWh}}$$

TCO: Total Cost Ownership

$W_{l,t}$: absorbed energy with lamps on $P_n \cdot t_d \cdot (F_d \cdot F_o \cdot F_c) + P_n \cdot t_n \cdot (F_o \cdot F_c)$ [kWh]

$W_{p,t}$: absorbed parasitic energy with lamps off $P_{pc} \cdot [t - (t_d + t_n)] + P_{em} \cdot t_e$ [kWh]

Artemide. The Network

● Headquarters

- 1 Artemide Group, Pregnana Milanese, Milan, Italy
- 2 Artemide Communication and Marketing Department, via Canova 34 - Milan, Italy

● European and North American Production Facilities

- 1 Artemide Pregnana Milanese, Milan, Italy
- 3 Artemide Telgate, Bergamo, Italy
- 4 Artemide Glass Factory, Vetrofond Srl, Venice, Italy
- 5 Artemide Architectural Sas, Saint Florent, France
- 6 A&A - Paks, Hungary
- 7 Artemide Manufacturing North America Montreal, Canada

● Worldwide Subsidiaries and Affiliated Companies

- 8 Artemide Italia, Milan, Italy
- 9 Artemide Illuminazione, Zurich, Switzerland
- 10 Artemide Handelsgesellschaft, Vienna, Austria
- 11 Artemide France, Paris, France
- 12 Artemide Gmbh, Fröndenberg, Germany
- 13 Artemide Deutschland, Fröndenberg, Germany
- 14 Artemide SA, Barcelona, Spain
- 15 Artemide GB, London, United Kingdom
- 16 Artemide Scandinavia, Copenhagen, Denmark
- 17 Artemide Agency, Moscow, Russia
- 18 Artemide Inc, Hicksville - New York, USA
- 19 Artemide Ltée, Quebec -Montreal, Canada
- 20 Edimetra, Buenos Aires, Argentina
- 21 Artemide Middle East, Dubai, UAE
- 22 Artemide HK Ltd, Hong Kong
- 23 Artemide Trading Shanghai, Shanghai, China
- 24 Artemide Japan, Tokyo, Japan
- 25 Artemide Lighting India, Mumbai, India

● Principal Distributors

Africa

- 26 Arrakis Sarl, Morocco
- 27 Spazio Lighting (Pty) Ltd, South Africa

America

- 28 Cynthron Comercial e Importadora e Servicos LTDA, Brasil
- 29 Interdesign, Chile
- 30 Inversiones Jam, Dominican Republic
- 31 Scultura Luminosa, Mexico
- 32 Trios Lighting, Uruguay

Asia

- 33 Lightcraft Sdn. Bhd, Malaysia
- 34 Million Lighting Company Private Limited, Singapore
- 35 T&S Trading Ltd, South Korea
- 36 Bravocasa Co., Ltd, Taiwan
- 37 Ornare Imports Pty Ltd, Australia
- 38 ECC Lighting, New Zealand

Europe

- 39 Artemide Hellas, Greece
- 40 Horas, Benelux
- 41 Foton Iluminação Ltda, Portugal

Middle East

- 42 Al Hassan Electricals Co. L.L.C., Oman
- 43 Cesar Debbas & Fils S.A.L., Lebanon
- 44 Light Technologies Co.Ltd, Saudi Arabia
- 45 Spaces & Concepts, Kuwait

● Showrooms

Europe

- 46 Austria, Wien
- 47 Belgium, Brussels
- 48 Denmark, Copenhagen
- 49 France, Paris
- 50 Germany, Frankfurt
- 51 Greece, Thessaloniki
- 52 Italy, Milan, Artemide Manzoni
- 53 Italy, Milan, Artemide Monforte
- 54 Italy, Rome, Artemide Margutta
- 55 Italy, Rome, Artemide Pisanelli
- 56 Poland, Warsaw
- 57 Portugal, Carnaxide
- 58 The Netherlands, Amsterdam
- 59 Switzerland, Zurich
- 60 United Kingdom, London

Worldwide

- 61 Argentina, Buenos Aires
- 62 Australia, Melbourne
- 63 Australia, Sydney
- 64 Canada, Toronto
- 65 China, Beijing
- 66 Hong Kong
- 67 Mexico, Ciudad de México
- 68 USA, Chicago
- 69 USA, Los Angeles
- 70 USA, Miami
- 71 USA, New York



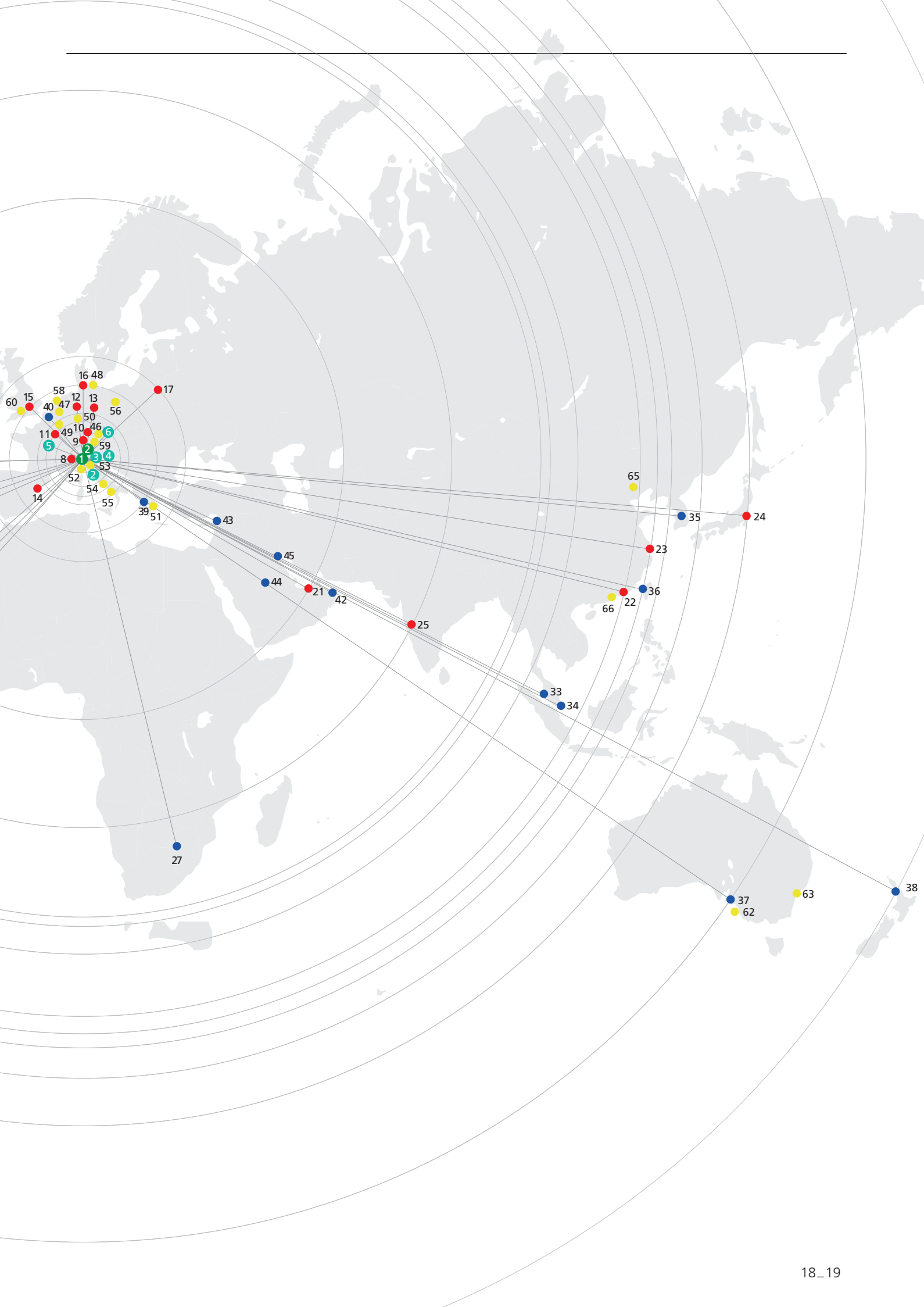

A Accuracy (of measurement)

Approximate agreement between the result of a measurement and the actual value of the item being measured. It is a qualitative term: the term "precision" should not be used as a synonym.

Active cooling

System composed of one or more radiators made of a conductive materials, plus a fan or another element conveying air on the radiator.

Adjustable dowers

Adjustable, removable partitions applied on a projector, able to screen its light as required.

Ampere (A)

The SI base unit used to measure the intensity of electric current.

Angle of inclination

Angle of inclination calculated upward from the horizontal of a lighting fixture.

Anti-dazzle grid

Element usually with square or hexagonal grid (other geometric shapes could be applied) able to cut unrequired, dazzling light rays that can cause glare. Its finish is usually black or aluminium. The shaped section allows the reflected light to be deviated towards specific angles, so that the dazzle effect is removed.

Asymmetric lens shield tube

Accessory located in front of a projector, able to cut unrequired, dazzling light rays that can cause glare.

Axial intensity

Lighting intensity emitted by any lighting device on its own main axis.

B Backup Lighting

Part of the emergency lighting provided to ensure that an exit can be identified efficiently and used if the normal lighting system does not work.

Beam

in a projector, or in a rotosymmetrical / X-Y type device, it is double the angle made by the direction of the axial luminous intensity and the direction where intensity is 1/2 of the axial.

BIN

A term used in the LED industry to define selections of: Colour (the BIN defines a variable area of the chromaticity diagram). Luminous Flux (the BIN defines the amount of luminous flux emitted). Vf (the BIN specifies the maximum and minimum values of the voltage drop applied across the LED terminals).

Black body

It is an ideal object absorbing all incident electromagnetic radiations. Being black, it is neither reflecting nor transmitting any energy. The black body produces electromagnetic radiation as a consequence of its temperature.

C Candela

SI unit of luminous intensity: the candela (cd) is the luminous intensity, in a given direction, of a light source that emits monochromatic radiation at a frequency of 540 THz and whose energy intensity in that direction is equal to 1/683 W per steradian.

Candela per square metre (m-2)

SI unit of luminance.

Catadiottric optic

Optical system usually mixed (refractive + reflective) on which reflection takes place, both because of the TIR principle and because of the use of mirrors.

CCT

Acronym of Correlated Color Temperature. It is expressed by the colour temperature in Kelvin degrees of a specific colour while in proximity of the black body curve in the different chromatic diagrams.

Cd/klm

Measurement unit of the luminous intensity. It is expressed in candles and is referred to the luminous flux installed, expressed in Kilo lumens.

Chromatic Rendering Index

Index evaluated by the ability to render a series of 14 colours, chosen using Munsell chromatic system, compared to a reference source depending on the colour temperature. If the colour temperature is below 5,000K, the reference source is the black body spectrum with the same colour temperature. If the CRI is higher, then the chosen reference source is a series D illuminant with colour temperature similar to the one of the source chosen.

Chromaticity diagram

Plane diagram in which the points, defined by the respective trichromatic coordinates, represent the chromaticity of colour stimuli.

Cold white

White colour of a light source with colour temperature greater than 5000 Kelvin.

Collimation lens

A lens directing the light rays incident on itself to the parallel optical axis of the lens itself.

Color temperature

It is the temperature of the black body producing a spectral emission with chromatic features similar to the source itself. The colours emitted by heating the black body are, starting from the lowest temperatures, red (up to 1,800K), orange (between 1,800 and 2,200K), warm white (between 2,200 and 3,500K), neutral white (between 3,500 and 5,000K), cold white (from 5,000K to infinity).

Color tolerance

Color difference inside a chromatic section of a lighting source (e.g. LED), usually produced by the manufacturer and identified with an acronym.

Colourimetry

Measurement of colours, based on a set of conventions.

Connector

Connecting element between two components of a system. It can be mechanical, electrical or electronic.

Cones

Photoreceptors of the retina containing pigments that are flexible in light which are the basis of the photopic vision process.

Constant current

See also definition of 'current'. Current supplied by an electrical device that is kept at a constant level. Constant current power supplies distribute a specific current within certain tension limits. These can vary from zero to a maximum value, or from a minimum to a maximum value.

Constant tension

See also definition of 'tension'. Tension supplied by an electrical device, kept at a constant level until its maximum power level is reached.

Contrast

Subjective adjustment of the difference in appearance of two parts of a visual field (observed simultaneously or in succession).

Current

Electrical charge flux (usually negative) passing through a surface during a time unit. It is a fundamental magnitude in the International System. It is measured in Ampere.

Cut off

In a photometric solid, it is the angle or the angles in which a net distinction between light and dark can be perceived. It is calculated in respect to the main axis of the device.

D Dali

Digital Addressable Lighting Interface. Protocol managing a system of light fittings through a signal transmitted by a single pair of wires. The DALI system can manage single or groups of light fittings included in the same system. Also, it can switch on and off and create scenarios with light fittings belonging to a same system.

Dali-SwitchDim

Compatibility of the power supply to work on a DALI protocol only or also through the SwitchDim function. In this last case, the load dimming is made through a simple push-to-make switch at the supply voltage.

Dark light

Device showing a luminance lower than 3,000 cd/m² in every 'C' plan for 'gamma' values equals or higher than 65°. It is calculated in respect to the main axis of the device. This value was originally 1,000 cd/m², now it is increased to 3,000 cd/m² for most devices.

Dialux

Light design software. Used to obtain all types of lighting calculations and related documentation in accordance with the legal regulations in force in various countries, as well as visualisations and animations for a realistic rendering of a project.

Diaphragm

element modulating the amount of luminous flux passing through an optic system. A so called 'vignetting' phenomenon takes place if openings of other elements interfere with the above.

Diffraction

Deviation of the direction of propagation of radiation, determined by its wave nature, which occurs when the waves are restricted by obstacles.

Diffused lighting

Lighting in which the light on the work surface or on an object does not come from any particular direction.

Diffuser

Optical element, transparent or opaque, able to diffuse its incident light rays in the surrounding space.

Diffusion

Phenomenon whereby the spatial distribution of a beam of radiation changes when the beam is deflected in multiple directions, by a surface or a medium, without changes of frequency in its monochromatic components.

Dimmable

Light fittings that can adjust their light intensity.

Direct glare

Glare produced by light sources in the visual field.

Direct lighting

Lighting by devices that distribute the light intensity in such a way that 90-100% of the luminous flux goes directly onto the work surface, assuming that this surface is not infinite.

Dispersion

The white light that falls on the face of a prism, is dispersed and flows out from the opposite face with the spectral components separated. This occurs because the index of refraction of a given material is a function of wavelength and therefore different colours (different wavelengths) are refracted at different angles.

DMX

DMX512, often abbreviated DMX (Digital MultipleX) is a communications protocol used mainly to control scene lighting [and] for control from computers or central units of complex lighting systems with moving or conventional lights. Each DMX512 cable can transmit up to 512 8-bit values between 0 and 255, so that a cable

can control up to 512 separate devices. Since DMX only supports 512 channels, there may be situations where separate DMX universes are needed. A DMX universe is a single line connecting the controller and all the devices associated with that cable. Most recent DMX consoles support more than one DMX universe, each of which must be wired independently. A DMX cable is made up of at least three poles for the transmission of signals.

Downlight

Device with direct emission, generally mounted in plasterboard ceilings. It is used in corridors (where no glare control is needed) and in workplaces (where conformity to standard UNI 12464 with regard to direct glare and glare on video terminals must be ensured). They are usually installed in the room in a regular grid so that the lights are spaced evenly at 1.8 x 1.8 metres or 2.4 x 2.4 metres.

E**Efficacy**

Ratio between the luminous flux of a lighting device and its power in watts. It is expressed in lumen/W.

Efficiency

Optical output; percentage ratio between the output luminous flux of the light fitting and the flux emitted by the light source. (See LOR)

Electrical connector

An electrical connector such as an electrical component, or an area of a printed circuit board, whose function is to electrically connect two or more electrical components exclusively by means of operations of a mechanical type (therefore without requiring electric welding).

Electrified track

Power supply system with voltage or low tension. Electrical conductors are located inside the track.

Electromagnetic wave

Electromagnetic energy carrier in single packs or 'quanta' of energy, with a defined energy value. It moves in a straight line at approximate 300,000 Km/s. It has associated magnetic and electrical fields varying in time following a sine law.

Elliptical reflector

Ellipsoidal mirror (rotational or not) that, with a light source on the first focus, can replicate its image on the second focus (if rotational ellipsoid) or on a specific area of the optical axis (if non rotational ellipsoid).

Emergency lighting

Lighting intended for use when a general lighting system fails due to a power failure.

Emission angle

See Beam.

EN 12464

Standard that defines lighting technology features such as average illumination, uniformity, colour rendering and UGR for interiors. This standard also defines the maximum luminance of a device to be used in environments where there are video terminals.

F**Field of Vision**

Of the eye or eyes. Angular width of the space in which an object can be when the observer looks at an object directly in front of him. The field can be monocular or binocular.

Filter

Optic element that can totally or partially select the wave lengths of a light source spectrum. In case of a total selection (net cut of the wave lengths between certain values), it is called a bandpass filter.

Flood

Term to identify a 2 ½ theta opening between 15 and 20° in a projector.

Fluorescent source

Discharge lamp of the low pressure mercury type in which most of the light is emitted by a layer of fluorescent material excited by the ultraviolet radiation of the discharge.

Fresnel lens

Element allowing construction of large optics and small focal distance without the obstruction, the thickness and the weight of the material used to produce a spheric conventional lens of equivalent dioptric power. The result is obtained dividing the spheric lens into a series of concentric circular sections, called Fresnel rings. For each zone the thickness of the lens is limited, while the continuous curve is transformed into a series of surfaces of non-continuous with the same curvature.

G**General Lighting**

Essentially uniform lighting of an area or a volume that does not take into account specific local needs.

Glare

Visual condition in which there is discomfort or reduction of vision, caused by an unsuitable distribution or degree of brightness or too much contrast in space and time.

Goniophotometer

Instrument for the measurement of photometric magnitudes, for measuring the angular distribution of a magnitude of brightness emitted by a light source, a lighting fixture, a medium or a surface.

H Halogen source

Lamp containing a tungsten filament and a small amount of one or more halogen gases for the purposes of cyclic regeneration of the filament.

Hybrid optic

Optical system in which both mirrors and lenses are used. More generally, both reflective and refractive elements are employed.

I Illuminance uniformity factor (on a given plane)

Measurement of the variation of illuminance on the plane concerned, expressed as: ratio between the minimum and maximum illuminance; ratio between the minimum and average illuminance.

Illumination

Photometric value showing the quantity of luminous flux for surface area. Common measurement units are lux (lumen / m²) used in the international system, and foot-candle (lumen/ft²) in the United States.

Localised illumination

Illumination designed to light an area with greater brightness in specific positions, such as where a very accurate visual task is being carried out.

Incandescent source

Lamp in which the light is produced using an element brought to incandescence by the passage of electric current, which emits radiation in the visible range.

Infrared radiation

Optical radiation having a wavelength greater than those of visible radiation.

Insulating class

homogeneous grouping defined by the IEC (International Electrotechnical Commission), indicating the technical features applicable to an electric device in order to reduce electrical hazards in case of fault. Class I electrical devices: the protection is based on the mains insulation and on a additional security measures. This is made by the connection of the conducting parts accessible to a protection conductor (protection earthing/grounding system) falling under the fixed electrical system. Class II electrical devices: also known as double insulation devices, are manufactured so that the earthing/grounding system is not required. In this case an eventual fault cannot cause the user to come into contact with dangerous electrical tensions. Class III electrical devices: the protection against electrocution is due to the use of SELV (Safety Extra-Low Voltage) security tension. The device is operated either by a battery or by a SELV transformer.

International System of Units

Abbreviated to "SI system" or sometimes just "SI", this is the set of units of measure agreed on by all countries that have signed the Metre Convention.

IP

International Protection (or protection class IP) is a code summing up the level of protection of an electrical appliance in case of accidental or intentional contact with a human body or with objects, and also the protection against contact with water. IPXX: the first digit shows the protection against the contact with solid bodies and the contact with dangerous parts. The second digit shows the protection against the contact with liquids.

Iso-illuminance curve, isolux curve

Locus of points belonging to a surface at which the light intensity has the same value.

K Kelvin

The kelvin (K) is a unit of measurement of temperature that is one of the seven base units of the International System of Units. In lighting, it is the measurement of the colour of light. See colour temperature.

L Lambert surface

Ideal surface that reflects the energy coming from one direction equally in all directions, and thus its luminance remains the same even if the viewpoint is different. It is therefore an ideal diffusing surface.

LED

Acronym of Light Emitting Diode. The LED is an electronic device made by the union of two elements composed of semiconductor material (typically silicon). The two elements are "doped", meaning that specific materials are added to them so that one has mainly negative charges (electrons) and the other one has mainly positive charges (holes). The passage of electrical current through the "junction" of the two elements causes the electron-hole recombination to occur, and this produces the phenomenon of the spontaneous emission of light at a given wavelength. The LED is therefore a monochromatic light emitter; white LEDs are blue LEDs which, through their radiation, excite phosphors which in turn, according to the same phenomenon of spontaneous emission, convert part of the blue radiation into others of the visible spectrum.

Lens

Optical element producing convergence or divergence of light rays on itself, thanks to refraction.

Life cycle

See Service Life.

Light

Portion of electromagnetic waves spectrum that are visible to the human eye.

Light guide

Transparent optical element transporting light by means of TIR effect, e.g. optic fibre.

LOR (Efficiency)

Acronym for Light Output Ratio. It is a percentage value obtained by the ratio between the luminous flux of a device and the luminous flux installed.

Louvre screen

Screen whose shielding elements are lamellae made of opaque or translucent material.

Lumen

SI unit of luminous flux. The lumen (lm) is the luminous flux emitted in a unit solid angle by a uniform point source having a luminous intensity of 1 candela.

Luminaire

Generic term to indicate a lighting device.

Luminance

Photometric value showing the luminous power of a light source for solid angle unit and for surface unit. It is used to define how bright a surface is at a certain angle. In the International System it is measured in candelas per square metre (cd/m²), in the United States in foot-lambert.

Luminous flux

Photometric value showing the amount of light emitted by a light source. It comes from the radiant flux (W) and is expressed in lumen.

Luminous intensity

photometric value expressing the lighting power of a source for solid angle unit. It is an essential value in the International System; it is used to define how bright a specific point is at a certain angle. It is measured in candelas (cd).

Lux (lx)

SI unit of illuminance. Illumination produced on a surface with an area of 1 square metre by a luminous flux of 1 lumen uniformly distributed on this surface.

LV (Low Voltage)

Components (electrified plates, optional extensions, cables and feeding kits) with 3-wire cables (+, -, signal) and 48VDC feeding tension. Feeding unit and control interfaces are needed in addition. Generally used for RGB LEDs, with the exception of Stand Alone versions.

M MacAdam Ellipse

In CIE chromatic diagrams, these are elliptical areas defining the ability of the human eye in perceiving colour differences from the centre of the elliptical area. E.g., a Step3 MacAdam Ellipse means that on average the human eye is able to perceive 3 different colours from the centre to the border of the ellipse.

Mean daylight factor

Ratio, expressed as a percentage, between the average illuminance of the room and the illumination under the same time conditions on an external horizontal surface that receives light from the sky.

Mesopic vision

Intermediate vision between photopic and scotopic vision.

Metal Halide

A light source that produces light, directly or indirectly, by an electric discharge through a gas, a vapour metal or by a mix of different gases or vapours.

Minimum/average illuminance

In a illumination (lux) or luminance (cd/m²) map, it is the ratio between the lower and the average value observed.

Monochromatic radiation

Radiation characterised by a single wavelength. By extension, radiation characterised by a light waveband so limited that it can be defined by the indication of a single wavelength.

Monochromatism

Electromagnetic radiation in which the energy is concentrated in a single wavelength. Strictly speaking, monochromatic spectra are only emitted by lasers, but in reality those emitted by LEDs are also defined as monochromatic radiations, even if they are not exactly so.

Multi lens optic

Optic system made of more lenses, used to make very precise projections. MV (Medium Voltage): components (electrified plates, optional extensions, cables and feeding kits) with 7-wire cables (Neutral, Direct Line, Indirect Line, Auxiliary Line, Earth, DALI1 and DALI2) and 230 VAC feeding tension. If dimming is required, an external DALI circuit complete with DALI power supply, group controller and scene controller is needed. Used for feeding and dimming fluorescent lamps, white LEDs, spot groups and RGB Stand Alone LED versions.

MV (Medium Voltage)

Components (electrified plates, optional extensions, cables and feeding kits) with 7-wire cables (Neutral, Direct Line, Indirect Line, Auxiliary Line, Earth, DALI1 and DALI2) and 230 VAC feeding tension. If dimming is required, an external DALI circuit complete with DALI power supply, group controller and scene controller is needed. Used for feeding and dimming fluorescent lamps, white LEDs, spot groups and RGB Stand Alone LED versions.

MWL (My White Light)

See Tunable White.

N Neutral white

White colour of a light source with a colour temperature between 3500 and 5000 Kelvin.

O Ohm's Law

In physics, Ohm's Law, whose name comes from the German physicist Georg Simon Ohm, expresses the constitutive law of proportionality between the electric potential difference across a conductor and the intensity of the electric

current passing through it. The constant of proportionality is the electrical resistance. Denoting the electric potential difference at the terminals of an electrical conductor with V , and the electric current passing through it with I , Ohm's law states that $V = R \cdot I$, where R is the electrical resistance characteristic of the conductor. It is a constant, regardless of the value of the current. The current comprises an ordered movement of electrons, driven by an electric field, which have kinetic energy. The work done on them by the field in the unit of time is given by the power. When the flow of charges passes through a resistor, part or all of the kinetic energy of the charges is transferred to the material. This phenomenon is called the Joule effect, and the power transferred to the material is given by: $P (W) = V (v) \cdot I (A)$

Optics

Part of physics that studies the phenomena connected with the emission, propagation and detection of light.

Optical radiation

Electromagnetic radiation having a wavelength between the X-ray transition region (≈ 1 mm) and the radio waves transition region (≈ 1 mm).

P Passive cooling

System composed of one or more radiators making sure that a light source (usually LED) is working at an adequate temperature. This system is based entirely on the shape and mass of the radiators.

Photon

From the Greek "Phos, photos" which means light, the photon or quantum of light is the elementary particle of energy making up electromagnetic radiation.

Photometric solid

Spatial representation of the light intensity radiated by any lighting body

Photometry

from greek FOTOS (light) and METRIA (measurement). Branch of physics studying the measurement of photometric values. These are related to the portion of electromagnetic waves spectrum that are visible to the human eye. Photometric values are obtained by radiometric values through integration of the radiometric spectrum, calculated on the photopic V curve (λ) multiplied by 683.

Photopic vision

Vision that occurs when the eye adapts to luminance levels greater than 3-4 candelas per square metre. The cones are considered the main active elements of vision in these conditions.

Planck's law

Planck's law is a law of physics devised by German physicist Max Planck, stating that the energy associated with electromagnetic radiation is transmitted in indivisible packets called quanta, each of which is associated with a single photon.

PMMA

Acronym for Poly Methyl MethAcrylate, a plastic material with transparency and appearance very similar to those of glass; it was initially marketed by German company Rohm under the trade name "Plexiglas". It is widely used in the automotive sector (rear lamp covers of cars and motorcycles) and in lighting.

Polycarbonate

Plastic material with excellent properties of mechanical resistance, especially to bending. It is used instead of glass or PMMA, where good impact resistance and good flexibility are required. It is sensitive to ultraviolet light, which is why it is often treated with paint that can filter the rays.

Power

The power is defined as the work (W) performed in a unit of time (t). According to the principle of equality between work and energy, power measures the amount of energy exchanged in the unit of time, in any transformation process, whether this is mechanical, electrical, thermal or chemical. Measured in watts (W).

Power supply

A power supply is an electrical device that changes the output electrical tension from AC alternate to DC continuous. The electrical power can be adapted in this way so that other electrical equipment can be used. Through a transformer, the level of output tension and current, and therefore power, are modified.

Primary optics

Elements that are first intercepted by light in an optical system.

Profile spot

projector with optic elements able to 'shape' the projection, obtaining a net distinction between light and dark in the projected light profile.

Projector

Optic device able to transfer lighting energy from a source to a projection plan. The transfer can be made replicating the image such as in cinema projectors (imaging optic) or without replicating the image such as in the illuminators (non imaging optic).

R Radiant energy

Energy emitted, transferred or received as radiation. Measured in joules, $j = W \cdot S$

Radiation

Emission or transportation of energy in the form of electromagnetic waves or particles.

Radiometry

From latin RADIUS (ray) and greek METRIA (measurement). Branch of physics studying measurement of radiometric magnitudes related to electromagnetic energy, such as radiating flux (W), radiating intensity ($W \cdot sr^{-1}$), radiation ($W \cdot m^{-2}$), radiance ($W \cdot sr^{-1} \cdot m^{-2}$).

Reflection

Physical phenomenon that occurs when a ray of light projects onto a mirror surface. The angle between the incident ray and the perpendicular to the incident point are equal to the angle between the reflected ray and the perpendicular to the incident point.

Reflectance

Ratio between the luminous flux reflected by a surface and the luminous flux incident on the surface.

Reflective Screen

Screen in which the shielding depends mainly on the phenomenon of refraction.

Reflector

Optic element able to reflect light. This term includes all elements treated with vacuum-sealed aluminium and producing a specular surface. It is a fact though that also all opaque elements are to some extent reflectors.

Refraction

physical phenomenon that occurs when a ray of light projects onto a border between two mediums with a different refraction index (or with two different densities). The refraction law, also known as Snell law, is defined as follows: $n \cdot \sin(i) = n' \cdot \sin(i')$. n and n' are refraction indexes of the first and second medium; " i " and " i' " are the angles relative to the perpendicular of, respectively, the incident ray and the refracted ray.

Remote Control

Infrared remote control for light management.

Retrofit

Light source using an advanced technology replacing an obsolete one with the same mechanical features.

Retroreflector

Optical device designed to deflect the rays that fall on it towards the source of the light. The rays undergo two refractions and a reflection in variously shaped elements.

RGB

Acronym for RED – GREEN – BLUE, used to identify systems with multi-coloured light sources which, through additive synthesis, can create all the colours of the visible range and their possible combinations, including white.

Rods

Photoreceptors of the retina in which pigments are sensitive to scotopic vision. Rods are considered not to play any role in the discrimination of colour stimuli.

S

Security lighting

Part of the emergency lighting system designed to ensure the safety of persons.

Saturation

Attribute of a visual sensation that allows you to judge the proportion of pure chromatic colour in the total sensation.

Scotopic vision

Vision that occurs when the eye adapts to luminance levels less than a few hundredths of a candela per square metre; the rods are considered the main active components of the eye in this condition. The spectrum appears not coloured.

Screen

Part of a lighting device consisting of translucent or opaque elements, geometrically arranged in such a way as to hide the lights from the observer at certain angles.

Secondary optics

In an optical system, these are elements that are intercepted by light in the second place. LED power supplies are created especially for the piloting of LED load. There are two main groups: the constant current power supplies regulate directly the current of the LED load, while the constant tension power supplies create a continuous tension through which other devices controlling LED loads can be operated.

Sensitivity

Quotient between the response Y of a detector and its excitation X .

Service Life

Time period from the first time a light source is switched on and a specific percentage of its estimated life span (e.g. 70%). LED manufacturers estimate the life cycle through tests lasting less than its determined life span. E.g L70 (6K)>36,000 hours means that the light source will produce a luminous flux higher than 70% of its initial luminous flux after 36,000 hours. Also, this estimate was performed through a test of 6,000 hours.

Solid angle

Solid angle subtended at the centre of a sphere by a cap with an area that is numerically equal to the square of the radius. Measured in steradian, sr.

Source

Any element able to product an electromagnetic radiation.

Spectrum

Distribution of a radiometric magnitude (radiance, radiation intensity, radiating flux), as a function of radiations frequency or wave length.

Standard EN60598-1

Standard regarding electrical safety of lighting devices.

Standard IEC/EN 62471

Standard regulating photo biological perspective of the usage of LED sources.

Steradian (sr)

SI unit derived from a solid angle which, having its vertex in the centre of a sphere, cuts an area of the spherical surface equal to that of a square having the radius of the sphere as its side.

T

TCO (Total Cost Ownership)

Latest generation calculation tool used to come up with lighting and system control solutions to ensure a targeted use of energy resources, starting from regular estimates of the costs of installing and operating the equipment.

Tension

Difference between the electric potential between two points in space, caused by their electrical power.

Thermal management

Management of the thermic dissipation of a light fitting, usually LED.

Thermal radiation

Emission process in which the radiant energy has its origin in the thermal agitation of the particles making up the matter (atoms, molecules, ions).

(Theta)

Theta - In a photometric solid with rotational or X-Y symmetry, the angle between the intensity vector with half the maximum value of the solid and a second intensity vector also with half the maximum value, but whose position is a mirror image of the first vector.

/2 (Theta ½)

In a photometric solid with rotational symmetry or XY symmetry, the angle between the maximum intensity vector of the solid and a second intensity vector with half the maximum value.

2 /½ (2 Theta ½)

In a device with rotational or X-Y symmetry, twice the angle between the maximum intensity and the intensity equal to half of the maximum.

TIR lens

Optical element that, associated with an LED, works as a parabolic reflector using the total reflection principle. This happens when the light hits a border between two optical mediums, one firmer and one softer. TIR is the acronym for Total Internal Reflection.

Transformer

Electrical device used to transform input and output electrical power parameters (tension, current intensity), maintaining constant electrical power. The transformer is a device that can be operated in alternate current, thanks to the electromagnetic principles linked to variable fluxes.

Tunable white

Light source able to create different tones of white light, going from warm (2,500K) to cold white (6,500K). It can be made of white or coloured sources.

Neutral white: white light with neutral colour temperature (3,500-5,000K).

Warm white: white light with warm colour temperature (2,500-3,500K).

Cool white: white light with cold colour temperature (5,000-10,000K).

U

UGR

Unigied Glare Ratio. Parameter expressing the glare of a light fitting, through the evaluation of its luminance.

Ultraviolet radiation

Optical radiation with wavelengths shorter than those of visible radiation. In the range between 100 and 400 nm, ultraviolet radiation is generally indicated with the symbols UVA between 315 and 400 nm, UVB between 280 and 315 nm and UVC between 100 and 280 nm.

Uni EN 12464 standard

UNI standard that establishes the lighting technology parameters related to workstations. The standard defines characteristics such as: Minimum illumination, uniformity, colour rendering of sources and UGR for various workplaces. This standard also prescribes the maximum permissible luminance of a device for its use in places where there are video terminals.

V

Very Wide Flood

Term to identify a $2\frac{1}{2}$ theta opening greater than 30° in a projector.

Visible radiation

Optical radiation that directly causes a visual sensation. Even if the range of wavelengths concerned in vision depends on the individual and on the illuminance on the retina, the lower limit is normally indicated between 360 nm and 400 nm and the upper limit between 760 nm and 830 nm.

Visual performance

Degree of effectiveness of the visual system, measured for example by the speed and accuracy with which a visual task is accomplished.

Visual task

Set of elements of the work performed.

Voltage drop

Voltage drop (V_f) is a synonym of the potential difference. More specifically if a resistor of resistance R is inserted between two points A and B of an electrical circuit and traversed by a current of intensity I , Ohm's law states that the electric potential at A is greater than at B in a quantity equal to $R \cdot I$. In other words, between A and B there is a potential difference, or voltage drop, equal to $\Delta V = R \cdot I$

W

Wall washer

Luminaire designed to illuminate the walls of buildings, whether external or internal; wall washers can be with white light or RGB, they are very frequently used to create spectacular effects outside.

Warm white

White colour of a light source with a colour temperature between 2700 and 3500 Kelvin.

Wavelength (λ)

Distance between two successive points, in the direction of propagation of a periodic wave, in which the oscillation has the same phase. Measured in metres (m) and nano metres (nm).

Wide Flood

Term to identify a $2\frac{1}{2}$ theta opening between 20° and 30° in a projector.

A.

Indoor

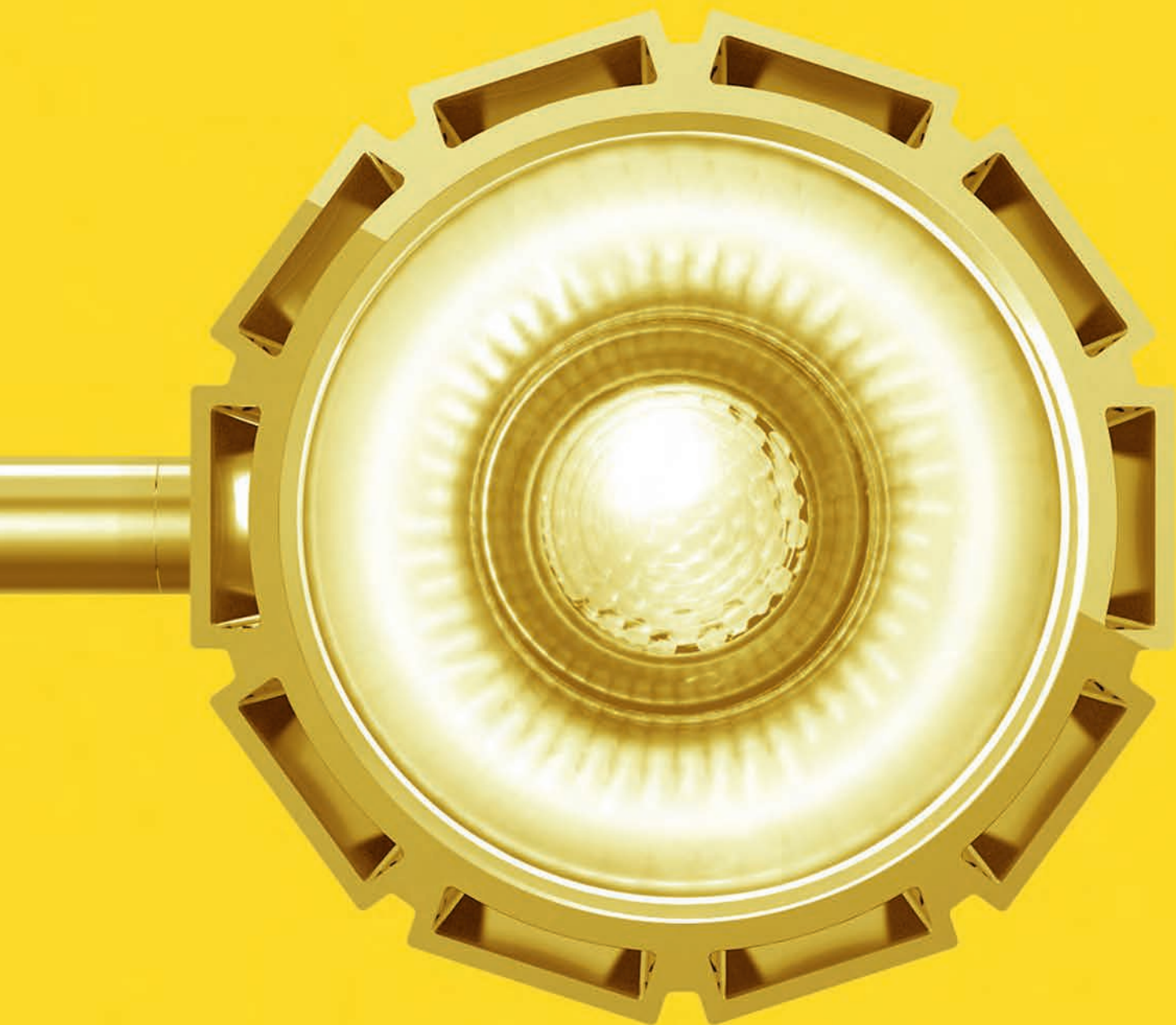

Projector	30	Cata
	62	Airlite
	82	Picto
	106	Tracks
	110	Caelum
	132	Java
	146	37 Cube
	156	PAD
	174	PAD 80

Cata

Carlotta de Bevilacqua
2012 - 2014





red dot design award
2014



product
design
award

2012



Cata Optical System



Cata Catadioptric

- High axial intensities with considerable beam collimation.
- High-precision accent lighting.
- Well defined narrow beams.
- Excellent light blending.

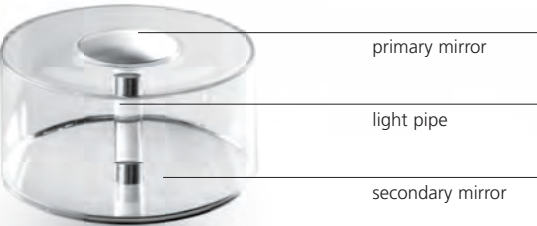

Cata TIR Total Internal Reflection

- Extremely compact dimensions.
- High efficiency.
- Wide availability of beam angles.
- Maximum control of light emission.
- Wide range of optical accessories.

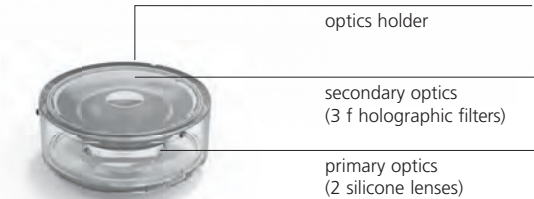



Cata Wide

Reflective & Refractive

- Soft, homogenous light.
- High efficiency.
- Diffused light effect produced by transparent material.



internal microlenses

external prisms at 90°





Cata Tunable White



TW®

Artemide Tunable White

- Cata projector in its Tunable White version is equipped with an innovative COB with adjustable colour temperature. The white colour temperature can be adjusted from 2700K to 5700K, with an impressive CRI >93 (min.)
- Its lighting performance looks to reproduce the best professional halogen sources in terms of the quality of light, with the added benefit of non-existent ultraviolet and infrared emissions.
- Cata projector is equipped with custom electronics, specifically designed to interface with different control devices through the DALI8 protocol.

2700 K

5700 K

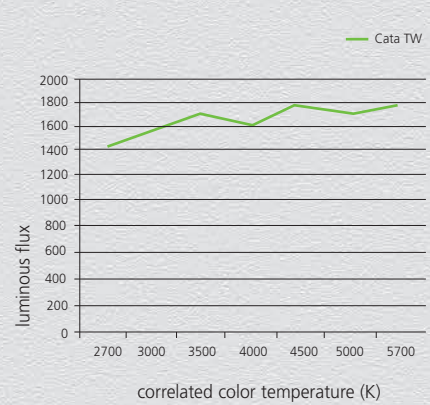
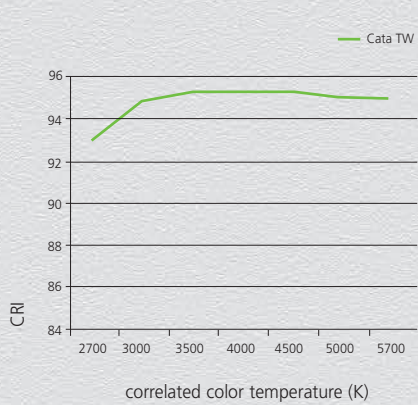
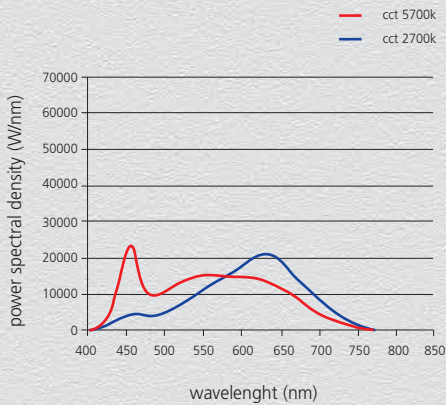
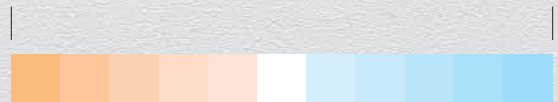

Cata tunable white



Track		
W	Weight	CCT
24 W	0,65 kg	2700 K - 5700 K

Dimmable Dali 8
Code
M057783

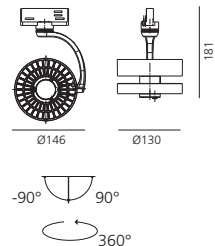

IP20 ⊕ 850°

Ceiling		
W	Weight	CCT
24 W	0,75 kg	2700 K - 5700 K

Dimmable Dali 8
Code
M057781

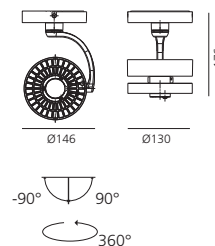

IP20 ⊕ 850°

Suspension		
W	Weight	CCT
24 W	0,75 kg	2700 K - 5700 K

Dimmable Dali 8
Code
M066981

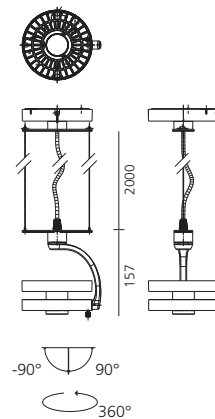

IP20 ⊕ 850°

Ceiling fix		
W	Weight	CCT
24 W	0,75 kg	2700 K - 5700 K

Dimmable Dali 8
Code
M067881

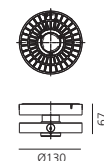

IP20 ⊕ 850°









Cata

- Interchangeable optical unit a 'twist & lock' mechanism.
- Defined, concentrated light beams thanks to an innovative collimation system.
- 2 beam angles: narrow (14°), spot (10°).
- Excellent quality of light:
- Cata Tuneable White: adjustable colour temperature from 2700K to 5700K CRI >93 (min.)
- Cata Stable White: available as warm white (3000K) and neutral white (4000K) – CRI=80 (min.)
- Rotation of 360°, tilt angle of +90°/-90°
- 4 installation options: with adaptor for 3-circuit track (ceiling only as envisaged by legislation), with power unit for ceiling installation in the adjustable and fixed version, with power unit for suspension installation in the adjustable version.
- Ultra-flat power source (8mm height): DALI dimmable as standard, DALI8 interface hub for Tuneable White version.
- If mounting on a track, it can be used with button on board unit with memory function.
- In all the other mounting modes, optional SwitchDimm operation and resident button with memory function.
- Materials : optic in transparent and metallic polycarbonate, heat sink in die-cast polished aluminium, feeder/power supply in transparent polycarbonate, arm in die-cast polished aluminium.
- Complies with EN60598 standard and other specific standards.



Optical unit

Cata is equipped with a system of interchangeable optics via a 'twist and lock' mechanism.

spot 10°



narrow 14°

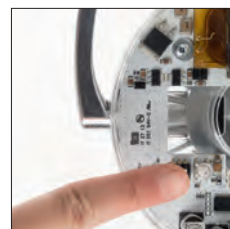

Patent pending (IT) n° MI2012A000605
Patent pending (US) n° 13/863.246
Patent pending (EU) n° 13163623.5

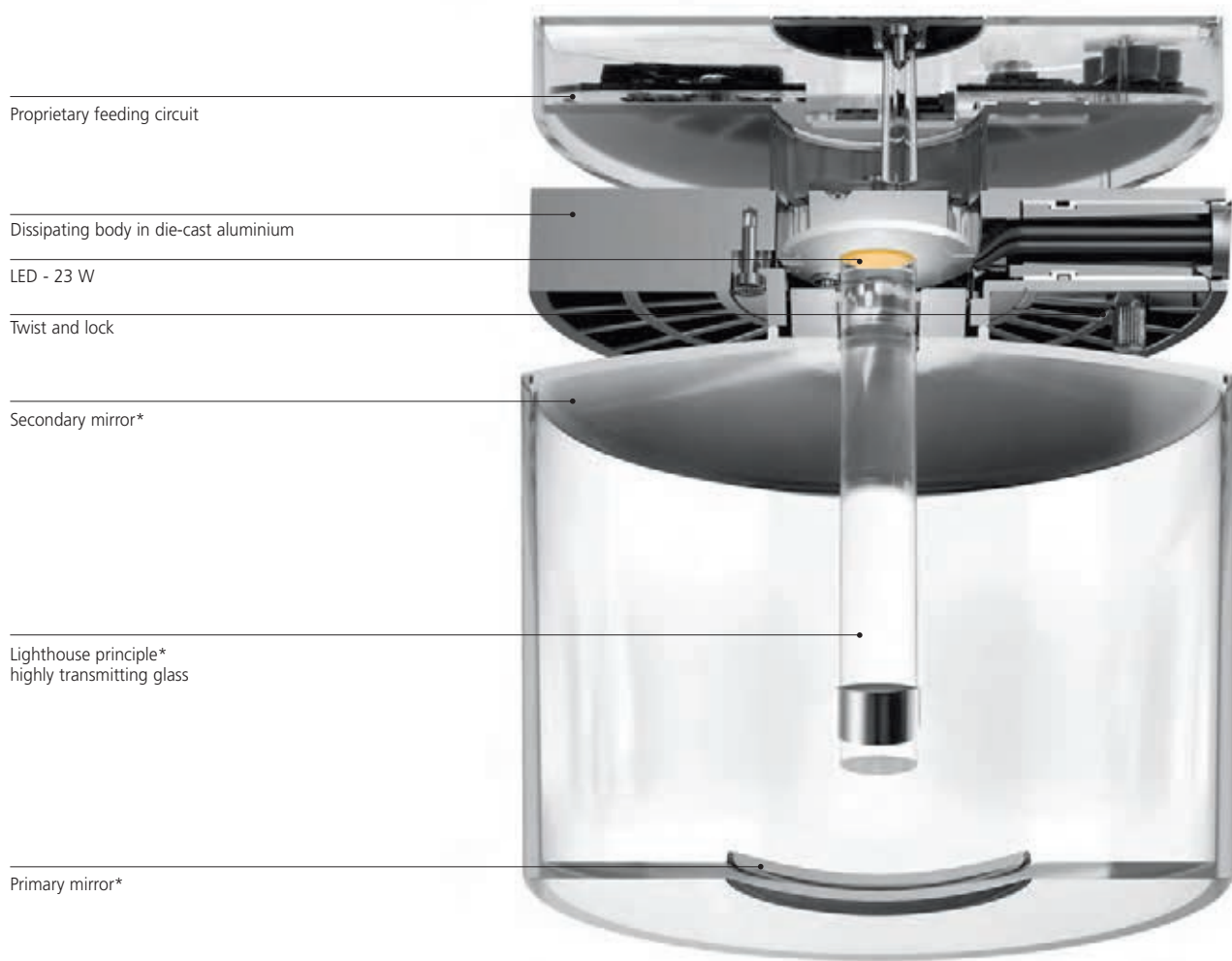

Cata catadioptric

Polished aluminium
●

Track

W	Weight	CCT
29 W	0,70 kg	3000 K
		4000 K

Dali

Code
M057383
M057483

To be used in conjunction with DALI 3-circuit tracks.
In absence of DALI bus, CATA can be dimmed using the button on the light fitting.

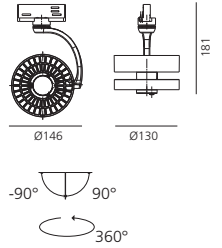

IP20 ☐

850°

Ceiling

W	Weight	CCT
29 W	0,70 kg	3000 K
		4000 K

Dali-SwitchDim

Code
M057381
M057481

In absence of Dali-SwitchDim bus, CATA can be dimmed using the button on the light fitting.

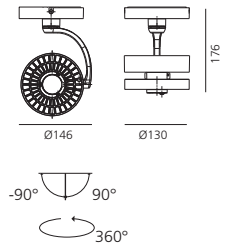

IP20 ☉

850°

Suspension

W	Weight	CCT
29 W	0,70 kg	3000 K
		4000 K

Dali-SwitchDim

Code
M0672W81
M0672N81

In absence of Dali-SwitchDim bus, CATA can be dimmed using the button on the light fitting.

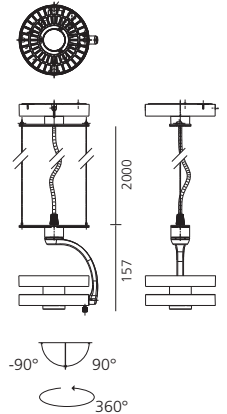

IP20 ☉

850°

Ceiling fix

W	Weight	CCT
29 W	0,70 kg	3000 K
		4000 K

Dali-SwitchDim

Code
M0677W81
M0677N81

In absence of Dali-SwitchDim bus, CATA can be dimmed using the button on the light fitting.

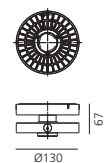

IP20 ☉

850°

Optic

Optical unit 10°

Weight	Beam	Code
0,25 kg	10°	M057500

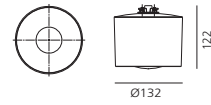

Cata 10°

LED	luminaire	
23 W	23 W	29 W
2300 lm	2440 lm	898 lm
3000 K	4000 K	3000 K
CRI =80 (min.)		
Color tolerance MacAdam 3SDCM		
Service life L70(6K)>36000h		
		10°
		37%
100 lm/W	106 lm/W	28 lm/W
		30 lm/W

29 W

3000 K

α=10°

4000 K

α=10°

Power	Flux	CCT	CRI	Color tolerance	Service life	Beam	Efficiency	Efficacy
23 W	2300 lm	3000 K	=80 (min.)	MacAdam 3SDCM	L70(6K)>36000h	10°	37%	100 lm/W
23 W	2440 lm	4000 K				10°	37%	106 lm/W
29 W	898 lm	3000 K				10°	37%	28 lm/W
29 W	951 lm	4000 K				10°	37%	30 lm/W

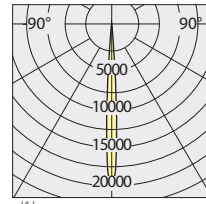

H _m	Ø _m	EMax _{lux}	EM _{lux}	H _m	Ø _m	EMax _{lux}	EM _{lux}
1	0,26	16488	11444	1	0,26	17458	12117
2	0,52	4122	2861	2	0,52	4365	3029
3	0,77	1832	1272	3	0,77	1940	1346
4	1,03	1032	715	4	1,03	1091	757
5	1,29	660	458	5	1,29	698	485

Optical unit 14°

Weight	Beam	Code
0,20 kg	14°	M057600

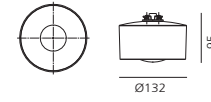

Cata 14°

LED	luminaire	
23 W	23 W	29 W
2300 lm	2440 lm	754 lm
3000 K	4000 K	3000 K
CRI =80 (min.)		
Color tolerance MacAdam 3SDCM		
Service life L70(6K)>36000h		
		14°
		33%
100 lm/W	106 lm/W	25 lm/W
		27 lm/W

29 W

3000 K

α=14°

4000 K

α=14°

Power	Flux	CCT	CRI	Color tolerance	Service life	Beam	Efficiency	Efficacy
23 W	2300 lm	3000 K	=80 (min.)	MacAdam 3SDCM	L70(6K)>36000h	14°	33%	100 lm/W
23 W	2440 lm	4000 K				14°	33%	106 lm/W
29 W	754 lm	3000 K				14°	33%	25 lm/W
29 W	800 lm	4000 K				14°	33%	27 lm/W

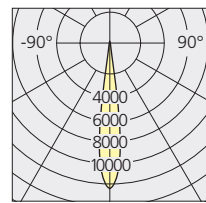

H _m	Ø _m	EMax _{lux}	EM _{lux}	H _m	Ø _m	EMax _{lux}	EM _{lux}
1	0,25	9877	6686	1	0,25	10480	7094
2	0,49	2469	1671	2	0,49	2620	1773
3	0,74	1097	743	3	0,74	1164	788
4	0,98	617	418	4	0,98	655	443
5	1,23	395	267	5	1,23	419	284





Cata TIR

- Interchangeable optical unit a 'twist & lock' mechanism.
- 5 available beams: narrow (8°), spot (16°), flood (28°), wide flood (48°), wall washer.
- 2 color temperatures: warm white (3000K) CRI=93 (min.), neutral white (4000K) CRI=90 (min.)
- Rotation of 360°, tilt angle of +90°/-90°.
- 4 installation options: with adaptor for 3-circuit track (ceiling only as envisaged by legislation), with power unit for ceiling installation in the adjustable and fixed version, with power unit for suspension installation in the adjustable version.
- Ultra-flat power source (8mm height): DALI dimmable as standard.
- If mounting on a track, it can be used with button on board unit with memory function.
- If using a ceiling and suspension mount, it can be used in SwitchDimm option and with button on board unit with memory function.
- Materials: optic in transparent polycarbonate and silicone, heat sink in die-cast polished aluminium, feeder/power supply body in transparent polycarbonate, arm in die-cast polished aluminium.
- Complies with EN60598-1 standard and other specific standards.



Optical unit

Cata Lens is equipped with a system of interchangeable optics via a 'twist and lock' mechanism.

narrow



spot



flood



wide flood



wall washer



Proprietary power supply

Die cast aluminum heat sink body

LED - 17,5 W

Twist and lock

Optical unit
narrow
spot
flood
wide flood
wall washer

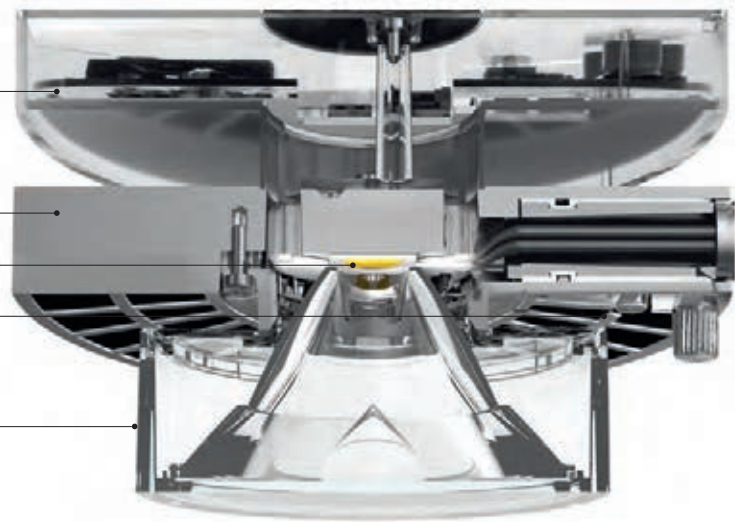

Cata TIR

Polished aluminium



Track

W	Weight	CCT
22,5 W	0,60 kg	3000 K
		4000 K

Dali

Code
M0569W83
M0569N83

To be used in conjunction with DALI 3-circuit tracks.
In absence of DALI bus, CATA can be dimmed using the button on the light fitting.

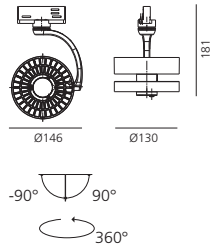

IP20 ☐

85°

Ceiling

W	Weight	CCT
22,5 W	0,70 kg	3000 K
		4000 K

Dali-SwitchDim

Code
M0569W81
M0569N81

In absence of Dali-SwitchDim bus, CATA can be dimmed using the button on the light fitting.

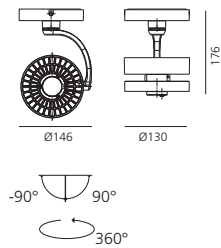

IP20 ☉

85°

Suspension

W	Weight	CCT
22,5 W	0,70 kg	3000 K
		4000 K

Dali-SwitchDim

Code
M0671W81
M0671N81

In absence of Dali-SwitchDim bus, CATA can be dimmed using the button on the light fitting.

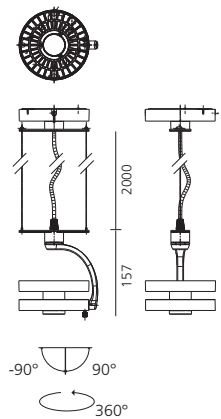

IP20 ☉

85°

Ceiling fix

W	Weight	CCT
22,5 W	0,70 kg	3000 K
		4000 K

Dali-SwitchDim

Code
M0676W81
M0676N81

In absence of Dali-SwitchDim bus, CATA can be dimmed using the button on the light fitting.

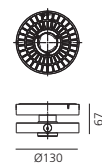

IP20 ☉

85°



Optic

Optical unit wide flood

Weight	Beam	Code
0,15 kg	48°	M109800



Cata Lens wide flood

	LED		luminaire	
	17,5 W	17,5 W	22,5 W	22,5 W
Power	17,5 W	17,5 W	22,5 W	22,5 W
Flux	1380 lm	1485 lm	837 lm	906 lm
CCT	3000 K	4000 K	3000 K	4000 K
CRI	=93 (min.) =90 (min.)			
Color tolerance	MacAdam 2SDCM			
Service life	L70(10K)>50000h			
Beam			48°	48°
Efficiency			61%	61%
Efficacy	79 lm/W	85 lm/W	38 lm/W	40 lm/W

22,5 W

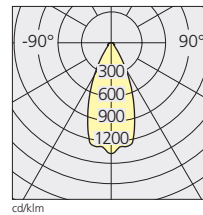

3000 K

α=48°

4000 K

α=48°

	H m	Ø m	EMax lux	EM lux	H m	Ø m	EMax lux	EM lux
1	0,83	1161	685	1	0,83	1256	742	
2	1,67	290	171	2	1,67	314	185	
3	2,50	129	76	3	2,50	140	82	
4	3,34	73	43	4	3,34	79	46	
5	4,17	46	27	5	4,17	50	30	

Optical unit ww

Weight	Beam	Code
0,15 kg	ww	M109900



Cata Lens ww

	LED		luminaire	
	17,5 W	17,5 W	22,5 W	22,5 W
Power	17,5 W	17,5 W	22,5 W	22,5 W
Flux	1380 lm	1485 lm	826 lm	891 lm
CCT	3000 K	4000 K	3000 K	4000 K
CRI	=93 (min.) =90 (min.)			
Color tolerance	MacAdam 2SDCM			
Service life	L70(10K)>50000h			
Beam			ww	ww
Efficiency			60%	60%
Efficacy	79 lm/W	85 lm/W	50 lm/W	40 lm/W

22,5 W

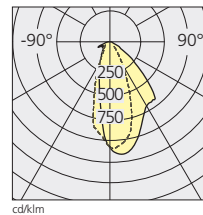

3000 K

α=ww







4000 K





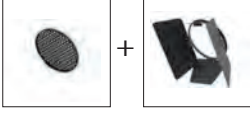

α=ww

	H m	Ø m	EMax lux	EM lux	H m	Ø m	EMax lux	EM lux
1	1,12	958	470	1	1,12	1033	507	
2	2,25	239	118	2	2,25	258	127	
3	3,37	106	52	3	3,37	115	56	
4	4,49	60	29	4	4,49	65	32	
5	5,61	38	19	5	5,61	41	20	



Accessories

Accessories configuration	narrow	spot	flood	wide flood
 <p>1 Glass filter Lens for elliptical emission Soft filter Chromatic filter</p>	●	●	●	●
 <p>Anti-dazzle louvre</p>	●	●	●	●
 <p>Adjustable dowsers</p>	●	●	●	●
 <p>Anti-dazzle louvre + Adjustable dowsers</p>	●	●	●	●
 <p>Anti-dazzle louvre + 1 Glass filter Lens for elliptical emission Soft filter Chromatic filter</p>	●	●	●	●
 <p>Adjustable dowsers + 1 Glass filter Lens for elliptical emission Soft filter Chromatic filter</p>	●	●	●	●
 <p>2 Glass filters Lens for elliptical emission Soft filter Chromatic filter</p>	●	●	●	●

	Color	Code
 <p>Accessories holder</p>	●	M057080
 <p>Lens for elliptical emission</p>		M282007
 <p>Soft filter</p>		M285207
 <p>Chromatic filter</p>	● Yellow ● Red ● Blue	M281745 M281755 M281735
 <p>Anti-dazzle louvre</p>	●	M282100
 <p>Adjustable dowsers</p>	●	M059910



Cata Wide





Cata Wide

- Interchangeable optical unit a 'twist & lock' mechanism.
- 2 color temperatures: warm white (3000K) CRI=93 (min.), neutral white (4000K) CRI=90 (min.)
- Rotation of 360°, tilt angle of +90°/-90°.
- 4 installation options: with adaptor for 3-circuit track (ceiling only as envisaged by legislation), base plate for ceiling mounting and with power unit for adjustable suspension installation.
- Ultra-flat power source (8mm height): DALI dimmable as standard.
- If mounting on a track, it can be used with button on board unit with memory function.
- If using a ceiling and suspension mount, it can be used in SwitchDimm option and with button on board unit with memory function.
- Materials: optic in transparent polycarbonate and silicone, heat sink in die-cast polished aluminium, feeder/power supply body in transparent polycarbonate, arm in die-cast polished aluminium.
- Complies with EN60598-1 standard and other specific standards.

Cata Wide Optical description

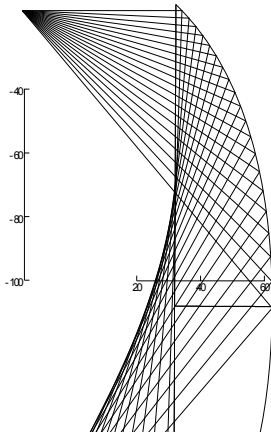

Design of optical section

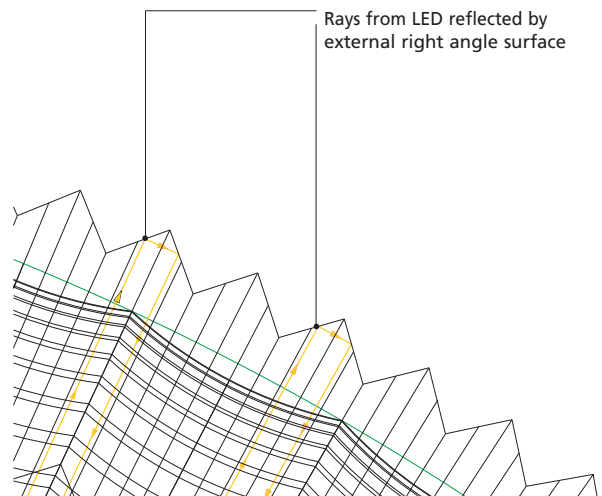

Solid structure with right angle prism to obtain total internal reflection

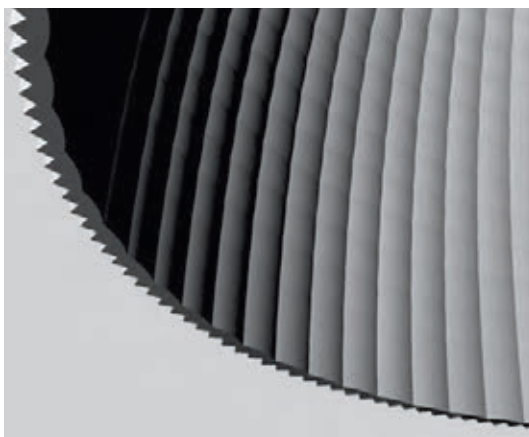

Spherical portion on internal surface to obtain a smooth and controlled light distribution

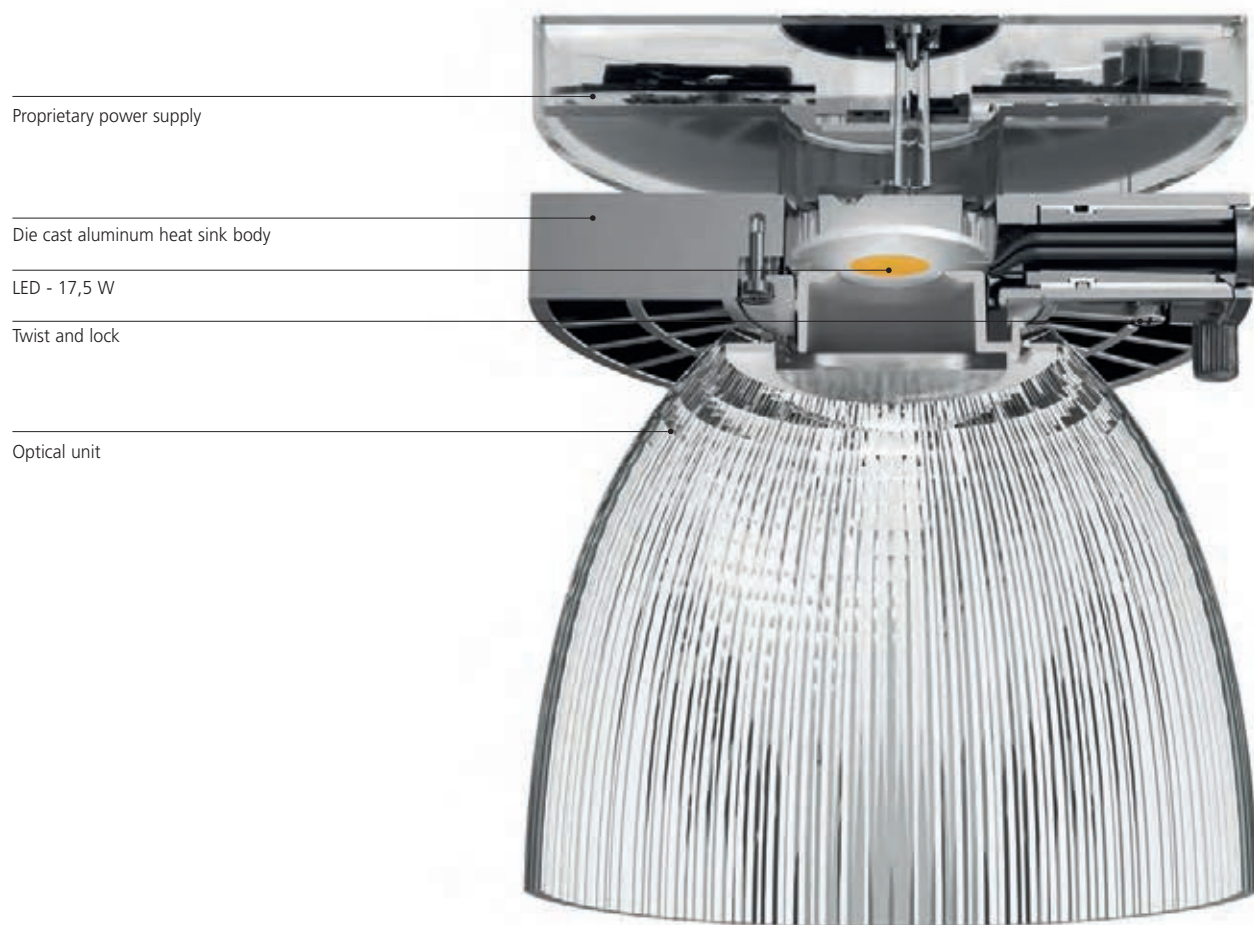

Efficiency of Cata Wide 93%
Direct light efficiency 83% - Ambient efficiency 10%

Cata Wide

Polished aluminium



Track

W	Weight	CCT
29 W	0,70 kg	3000 K
		4000 K

Dali

Code
M057383
M057483

To be used in conjunction with DALI 3-circuit tracks.
In absence of DALI bus, CATA can be dimmed using the button on the light fitting.

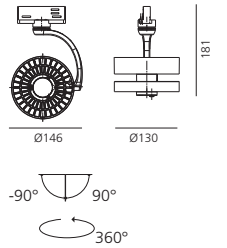

IP20 ☐

850°

Ceiling

W	Weight	CCT
29 W	0,70 kg	3000 K
		4000 K

Dali-SwitchDim

Code
M057381
M057481

In absence of Dali-SwitchDim bus, CATA can be dimmed using the button on the light fitting.

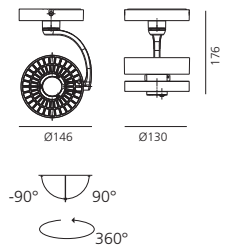

IP20 ☉

850°

Suspension

W	Weight	CCT
29 W	0,70 kg	3000 K
		4000 K

Dali-SwitchDim

Code
M0672W81
M0672N81

In absence of Dali-SwitchDim bus, CATA can be dimmed using the button on the light fitting.

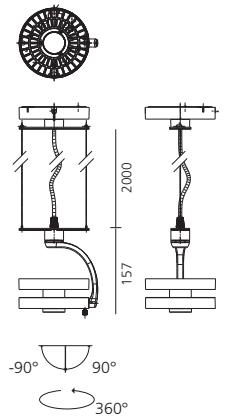

IP20 ☉

850°

Ceiling fix

W	WEIGHT	CCT
29 W	0,70 kg	3000 K
		4000 K

Dali-SwitchDim

CODE
M0677W81
M0677N81

In absence of Dali-SwitchDim bus, CATA can be dimmed using the button on the light fitting.

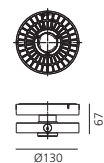

IP20 ☉

850°

Optic

Optical unit 64°

Weight	Beam	Code
0,30 kg	64°	M057800

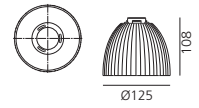

Cata 64°

	LED		luminaire	
Power	23 W	23 W	29 W	29 W
Flux	2300 lm	2440 lm	2013 lm	2134 lm
CCT	3000 K	4000 K	3000 K	4000 K
CRI	=80 (min.)			
Color tolerance	MacAdam 3SDCM			
Service life	L70(6K)>36000h			
Beam			64°	64°
Efficiency			83%	83%
Efficacy	100 lm/W	106 lm/W	64 lm/W	67 lm/W

29 W

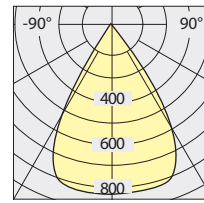

3000 K

α=64°

4000 K

α=64°

	H m	Ø m	E _{Max} lux	E _M lux	H m	Ø m	E _{Max} lux	E _M lux
1	1,29	1,29	1618	945	1	1,29	1716	1001
2	2,58	2,58	405	236	2	2,58	429	250
3	3,86	3,86	180	105	3	3,86	191	111
4	5,16	5,16	101	59	4	5,16	107	63
5	6,44	6,44	65	38	5	6,44	69	40



Boasting elevated luminous flux, excellent colour rendering, energy efficiency, and a light compact design, Airlite is an innovative range of LED spotlights with exceptional photometric performance and flexibility. Thanks to an innovative heat dissipation system, air is filtered through open gaps in the die-cast aluminium body, ensuring the efficiency and long life of our LED module. The hybrid optical system provides defined narrow beams, while keeping the light fixture dimensions compact.

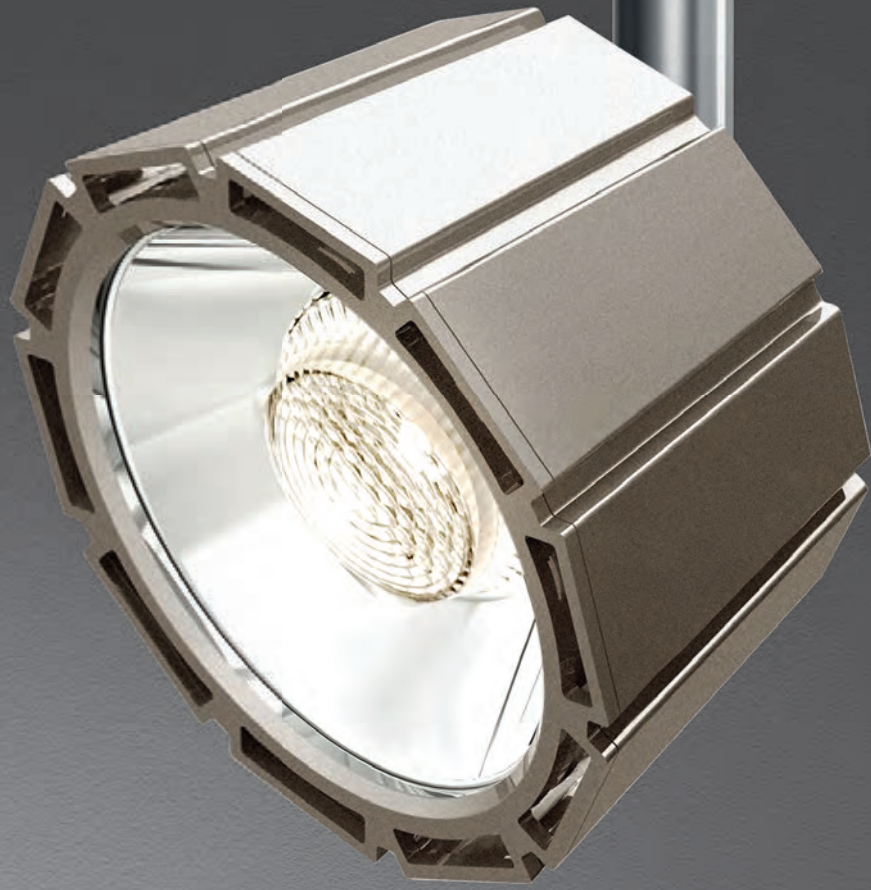

Airlite



- 3400 flux lumen output.
- Unique minimal dimensions and virtually weightless: max diameter 139mm x height 85mm. Weight of the die-cast head is 450g.
- High energy efficiency: between 71 and 81 lumens per watt in the spotlight version.
- Innovative LED thermal management (30W): passive heat dissipation system based on a chimney effect.
- Thin, extremely defined beams, thanks to the hybrid optical system.
- Beam angles: 16°, 35°.
- Excellent quality of light:
Airlite Tuneable White: colour temperature can be adjusted from 2900K to 5500K
CRI >91 (min.)
Airlite Stable White in tone: warm white (3000K) and neutral white (4000K) – CRI >91 (min.)
- Rotation of 360°, tilt angle of +90°/-90°.
- Available accessories include: elliptical refractor, soft and coloured filters, asymmetric tube, anti-dazzle louvre, adjustable dowsers.
- In addition to adjustable dowsers or asymmetric tube, it is possible to install up to 3 filters / refractors at the same time, or one filter plus the anti-dazzle louvre.
- 3 installation options: with adaptor for 3-circuit track (ceiling mounted version only), with base plate for semi-recessed mounting, or suspension.
- Standard version: DALI dimmable.
Tuneable White version: DALI8
- Materials: body in die-cast aluminium, reflector in optical aluminium, lens in polycarbonate.
- Complies with standard EN60598-1 and other specific regulations.



Airlite

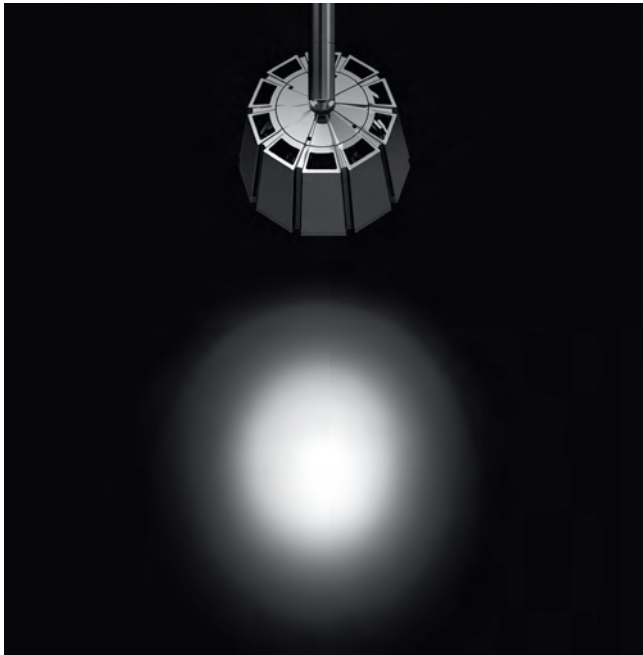

Spot
Beam angle 16°
For accent lighting small objects.

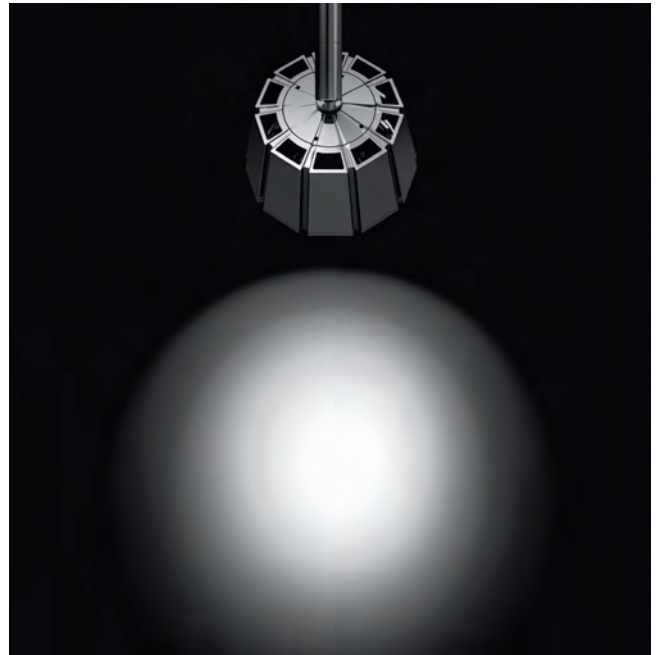

Flood
Beam angle 35°
For accent lighting of large objects.



Innovative thermal management

The die-cast aluminium body has a distinctive design, increasing thermal dissipation. Air is circulated through open gaps, allowing heat to travel out of the fitting, ensuring efficiency and long life of the LED module. This solution enables the integration of considerable power (30W LED power) into an extremely compact and virtually weightless design.
 Dimensions: max diameter 139mm x height 85mm
 Weight die-cast head: 450g

Hybrid optical system lens/reflector

Airlite uses high power LED modules within a hybrid optical system (lens and reflector) producing defined narrow beams. The Airlite 'hybrid' optic technology provides indirect light via a compact reflector adjusted and redirected through the lens. An innovative solution allowing considerably reduced product dimensions.
 Beam angles: 16° / 35°

LED

Power LED: 30 W



Airlite Accessories

Colored filters



Soft filter





Elliptical refractor



Adjustable dowsers



Anti-dazzle louvre



Asymmetric lens shield



Airlite

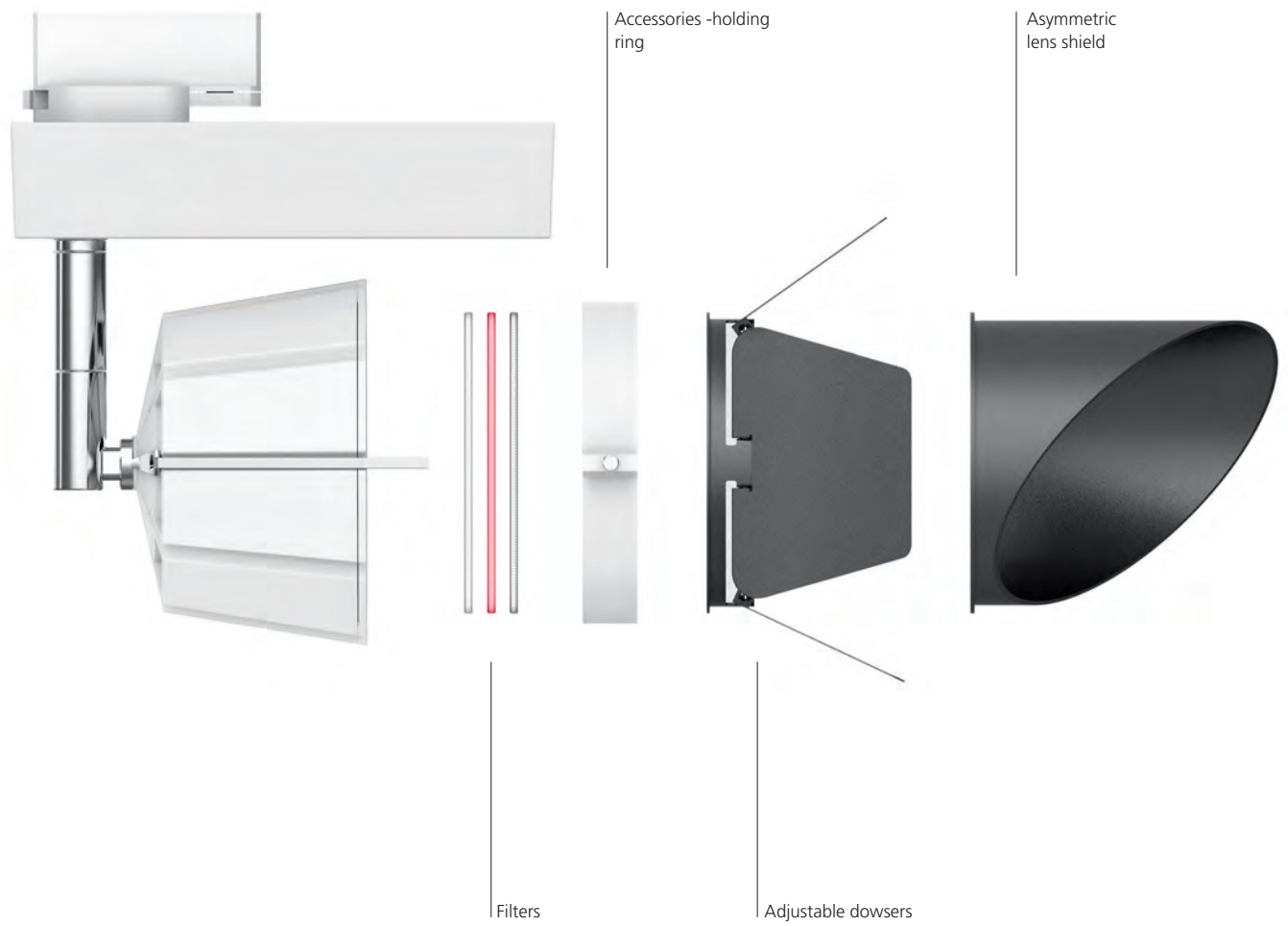

It is possible to install up to 3 filters/reflectors at the same time, in addition to adjustable dowsers and asymmetric lens shield.

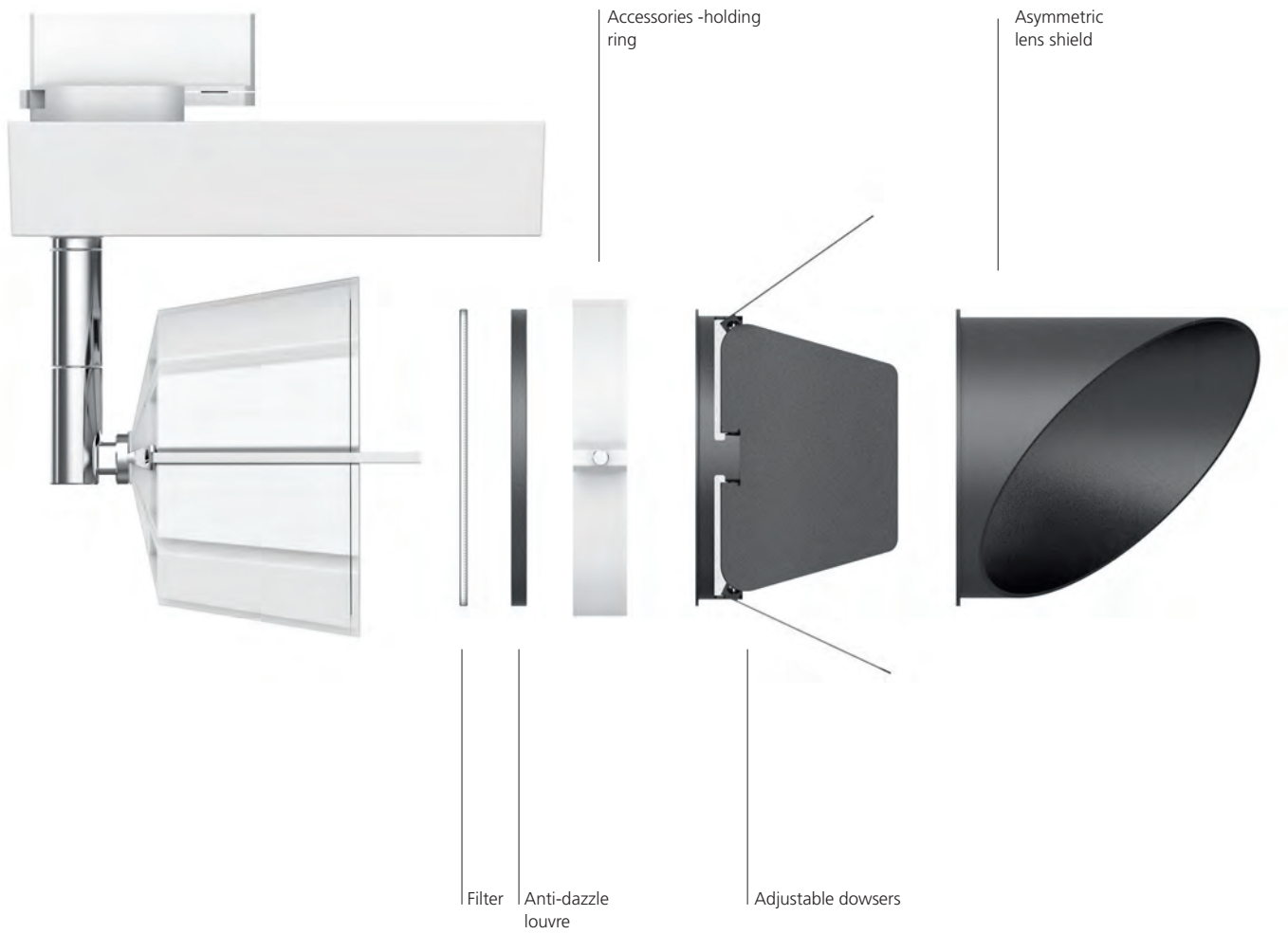

It is possible to install 1 filter plus anti-dazzle louvre at the same time, in addition to adjustable dowers and asymmetric lens shield.

Airlite

White ○ Black ● Polished aluminium ● Bronze ●

Track					
W	Weight	Beam	Flux	CCT	Color
35 W	1,60 kg	16°	2544 lm	3000 K	○
					●
					●
		2705 lm	4000 K	○	
				●	
				●	
	35°	2360 lm	3000 K	○	
				●	
				●	
	2510 lm	4000 K	○		
			●		
			●		

Non dimmable	
Code	
M141020	
M141010	
M141080	
M141050	
M141220	
M141210	
M141280	
M141250	
M141120	
M141110	
M141180	
M141150	
M141320	
M141310	
M141380	
M141350	

Dali dimmable	
Code	
M141021	
M141011	
M141081	
M141051	
M141221	
M141211	
M141281	
M141251	
M141121	
M141111	
M141181	
M141151	
M141321	
M141311	
M141381	
M141351	



IP20 ⊕ 90° 350° 850°

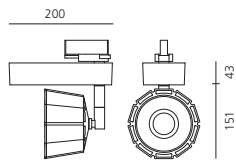

220/240Vac 50/60Hz electronic ballast included.

Semi-recessed					
W	Weight	Beam	Flux	CCT	Color
35 W	1,30 kg	16°	2544 lm	3000 K	○
					●
					●
		2705 lm	4000 K	○	
				●	
				●	
	35°	2360 lm	3000 K	○	
				●	
				●	
	2510 lm	4000 K	○		
			●		
			●		

Non dimmable	
Code	
M141420	
M141410	
M141480	
M141450	
M141620	
M141610	
M141680	
M141650	
M141520	
M141510	
M141580	
M141550	
M141720	
M141710	
M141780	
M141750	

DALI-SwitchDim	
Code	
M141421	
M141411	
M141481	
M141451	
M141621	
M141611	
M141681	
M141651	
M141521	
M141511	
M141581	
M141551	
M141721	
M141711	
M141781	
M141751	



IP20 ⊞ 90° 350° 850° ∅99

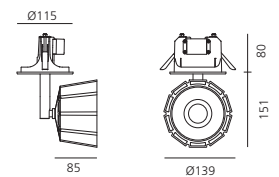

220/240Vac 50/60Hz electronic ballast included.

Ceiling					
W	Weight	Beam	Flux	CCT	Color
35 W	1,30 kg	16°	2544 lm	3000 K	○
					●
					●
		2705 lm	4000 K	○	
				●	
				●	
	35°	2360 lm	3000 K	○	
				●	
				●	
	2510 lm	4000 K	○		
			●		
			●		

Non dimmable	
Code	
M140620	
M140610	
M140680	
M140650	
M140820	
M140810	
M140880	
M140850	
M140720	
M140710	
M140780	
M140750	
M140920	
M140910	
M140980	
M140950	

DALI-SwitchDim	
Code	
M140621	
M140611	
M140681	
M140651	
M140821	
M140811	
M140881	
M140851	
M140721	
M140711	
M140781	
M140751	
M140921	
M140911	
M140981	
M140951	



IP20 ⊞ 90° 350° 850°

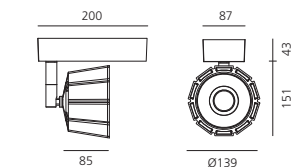



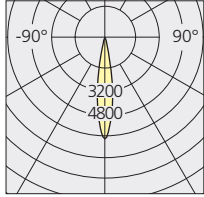

220/240Vac 50/60Hz electronic ballast included.

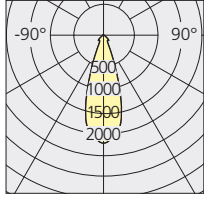

Airlite 16°	LED		luminaire	
Power	30 W	30 W	35 W	35 W
Flux	3353 lm	3564 lm	2544 lm	2705 lm
CCT	3000 K	4000 K	3000 K	4000 K
CRI	=80 (min.)			
Color tolerance	MacAdam 3SDCM			
Service life	L70(9K)>50000h			
Beam			16°	16°
Efficiency			76%	76%
Efficacy	112 lm/W	119 lm/W	73 lm/W	77 lm/W

35 W	3000 K		α=16°		4000 K		α=16°	
	H _m	Ø _m	EMax _{lux}	EM _{lux}	H _m	Ø _m	EMax _{lux}	EM _{lux}
	0,5	0,15	66306	32115	0,5	0,15	70495	34144
	1,0	0,30	16576	8029	1,0	0,30	17624	8536
	1,5	0,45	7367	3568	1,5	0,45	7833	3794
	2,0	0,60	4144	2007	2,0	0,60	4406	2134
	2,5	0,75	2652	1285	2,5	0,75	2820	1366
	3,0	0,90	1842	892	3,0	0,90	1958	948

Airlite 35°	LED		luminaire	
Power	30 W	30 W	35 W	35 W
Flux	3310 lm	3510 lm	2360 lm	2510 lm
CCT	3000 K	4000 K	3000 K	4000 K
CRI	=80 (min.)			
Color tolerance	MacAdam 3SDCM			
Service life	L70(9K)>50000h			
Beam			35°	35°
Efficiency			71%	71%
Efficacy	110 lm/W	117 lm/W	67 lm/W	72 lm/W

35 W	3000 K		α=35°		4000 K		α=35°	
	H _m	Ø _m	EMax _{lux}	EM _{lux}	H _m	Ø _m	EMax _{lux}	EM _{lux}
	1	0,61	5521	3467	1	0,61	5871	3687
	2	1,21	1380	867	2	1,21	1468	922
	3	1,82	613	385	3	1,82	652	410
	4	2,43	345	217	4	2,43	367	230
	5	3,03	221	139	5	3,03	235	147

Accessories		Color	Code
	Accessories holder	○ ● ● ●	M077820 M077810 M077880 M077850
	Lens for elliptical emission		M078700
	Soft filter		M078800
	Chromatic filter	● ● ●	M078900 M079000 M079100

Accessories		Color	Code
	Anti-dazzle louvre	●	M078400
	Asymmetric lens shield	●	M078500
	Adjustable dowsers	●	M078600





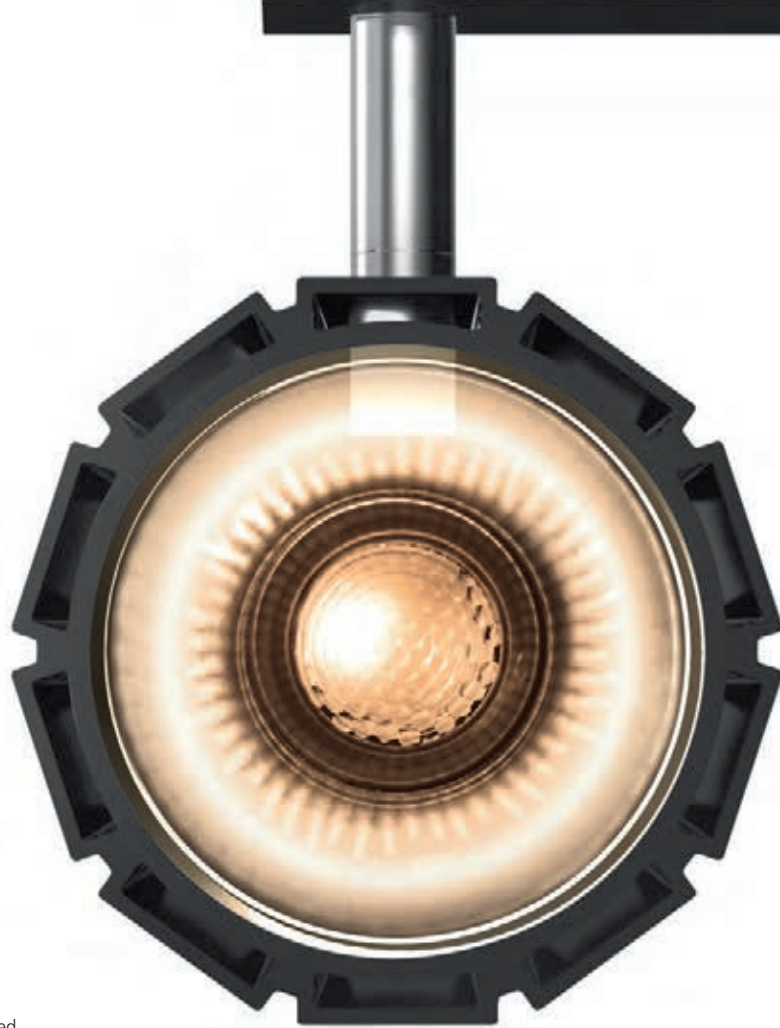

TW®

Artemide Tunable White

Airlite Tuneable White projector is equipped with an innovative LED ARRAY of varying colour temperatures: The LED diodes combine to achieve efficient, chromatic uniformity, allowing users to adjust the colour temperature via an electronic control device.

The Airlite Tuneable White projector is a perfect fixture for the retail environment. The ability to adjust colour temperatures from 2900K to 5500K allows for variations in light and atmosphere, giving users the opportunity to highlight different colours, while guaranteeing a high colour rendering indexing (CRI >91 (min.)) with an efficient product (above 85 Lm/W) across the entire spectrum.





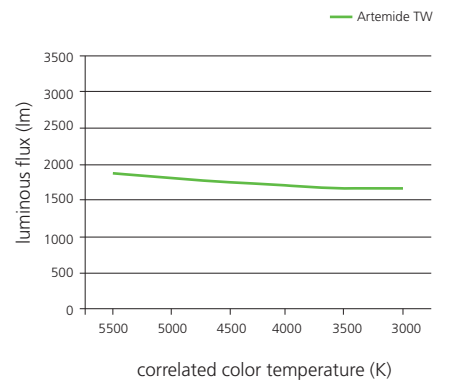
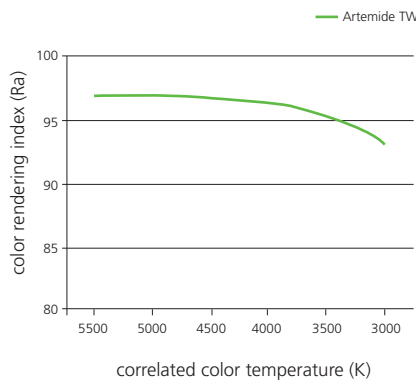
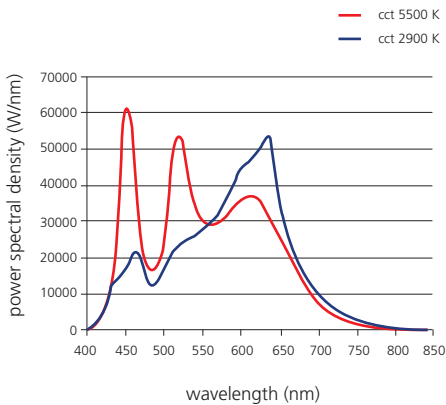

The unique mix of LEDs has been selected to ensure perfect positioning of this light source on the black body locus.









Airlite Tuneable White projector is equipped with custom electronics, specifically designed to interface with different control devices via the DALI8 protocol.





Airlite tunable white

White  Black  Polished aluminium  Bronze 

Track					
W	Weight	Beam	Flux	CCT	Color
35 W	1,60 kg	16°	1748 lm	2900 K-	
				5500 K	
					
		35°	1578 lm	2900 K-	
				5500 K	
					

Dali 8 dimmable	
Code	
M142221	
M142211	
M142281	
M142251	
M142321	
M142311	
M142381	
M142351	



IP20 
850°
 90°  350°

220/240Vac 50/60Hz electronic ballast included

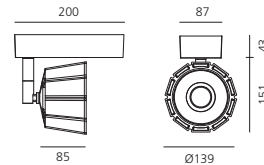



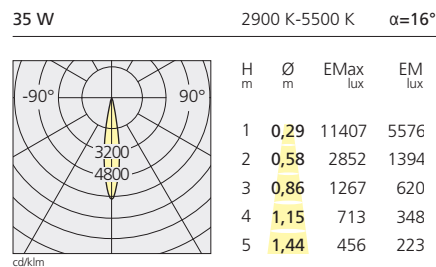



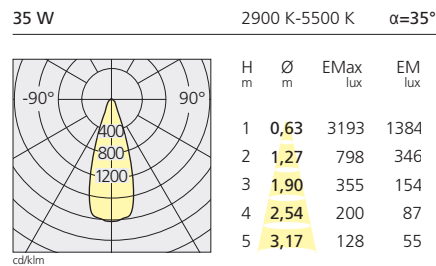





Airlite 16° TW	LED	luminaire
Power	30 W	35 W
Flux	2428 lm	1748 lm
CCT	2900 K-5500 K	2900 K-5500 K
CRI	>91 (min.)	
Color tolerance		
Service life		
Beam		16°
Efficiency		72%
Efficacy	81 lm/W	50lm/W



Airlite 35° TW	LED	luminaire
Power	30 W	35 W
Flux	2428 lm	1578 lm
CCT	2900 K-5500 K	2900 K-5500 K
CRI	>91 (min.)	
Color tolerance		
Service life		
Beam		35°
Efficiency		65%
Efficacy	81 lm/W	45 lm/W



Accessories		Color	Code
	Accessories holder	   	M077820 M077810 M077880 M077850
	Lens for elliptical-emission		M078700
	Soft filter		M078800

Accessories		Color	Code
	Anti-dazzle louvre		M078400
	Asymmetric lens shield		M078500
	Adjustable dowsers		M078600





Airlite suspension

White ○ Black ● Polished aluminium ● Bronze ●

W	Weight	Beam	Flux	CCT	Color	Code
24 W	0,95 kg	78°	1492 lm	3000 K	○	M141820
					●	M141810
			1596 lm	4000 K	●	M141880
					●	M141850
					○	M141920
					●	M141910
					●	M141980
					●	M141950

Non dimmable



IP20 ⊕
850°

220/240Vac 50/60Hz electronic ballast included.

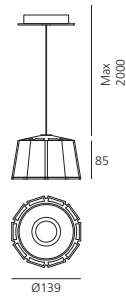

Airlite 78°

LED	luminaire			
Power	21 W	21 W	24 W	24 W
Flux	2260 lm	2420 lm	1492 lm	1596 lm
CCT	3000 K	4000 K	3000 K	4000 K
CRI	=80 (min.)			
Color tolerance	MacAdam 3SDCM			
Service life	L70(6K)>35000h			
Beam			78°	78°
Efficiency			66%	66%
Efficacy	108 lm/W	115 lm/W	62 lm/W	67 lm/W

24 W 3000 K α=78° 4000 K α=78°

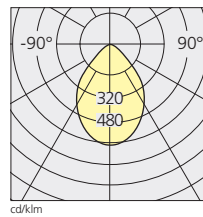

H	Ø	EMax	EM	H	Ø	EMax	EM
m	m	lux	lux	m	m	lux	lux
1	1,60	976	234	1	1,60	1044	250
2	3,19	244	58	2	3,19	261	63
3	4,79	108	26	3	4,79	108	26
4	6,39	61	15	4	6,39	65	16
5	7,98	39	9	5	7,98	42	10





Picto

Studio Artemide
2013 (LED)
2009 (Other sources)





This range of professional projectors is distinguished by design, excellent performance and flexibility. Picto is a complete and versatile range, suitable for use in retail spaces, showrooms, museums or art galleries. Available in 3 sizes, with different light sources (LED, metal halide), installation options, designs, colours, optics and a wide range of accessories.

Picto

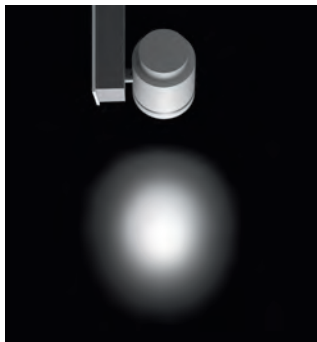

Spot (SP)
 $10^\circ < \text{angle} \leq 20^\circ$
 To highlight small objects.



Medium flood (MFL)
 $20^\circ < \text{angle} \leq 30^\circ$
 Standard feature for accent lighting of objects of all sizes.



Flood (FL)
 $30^\circ < \text{angle} \leq 40^\circ$
 For accent lighting of large objects.



Wide flood (WFL)
 $40^\circ < \text{angle} \leq 60^\circ$
Very Wide flood (VWFL)
 $\text{angle} > 60^\circ$
 For diffused lighting of surfaces and parts of an environment, or to highlight products.

		SP	MFL	FL	WFL	VWFL
Picto 70	LED	•			•	
	HIT	•	•	•		
Picto 100	LED	•		•		
	HIT	•	•	•	•	
Picto 125	LED		•	•		
	HIT		•		•	•



LED

HIT





- Series of high-output LED adjustable projectors, available also in metal halide.
- 3 colours available.
- Optical units available in 3 sizes, depending on the light source: 70 mm, 100 mm, 125 mm.
- Defined narrow beams in the LED version, thanks to the hybrid optical system (Picto 125).
- Beam angles between 10° and 66°.
- Excellent quality of light:
- Picto 125 Tuneable White (LED): colour temperature can be adjusted from 2,900K to 5,500K – CRI>91 (min).
- Picto 70, 100, 125 White (LED): available in warm white (3000K) and neutral white (4000K). CRI=80 (min. Picto 125), CRI=82 (typ Picto 70,100).
- Adjustability: -90°/+90°, rotation up to 355°.
- Precise aiming of the projectors, thanks to advanced locking system.
- Wide range of accessories: UV filters, chromatic filters, louvres, asymmetric diffuser, adjustable dowsers, Gobo to project images or control shape of beam.
- 2 installation options: with 3-circuit track adapter (available for ceiling mounted option), or base plate for ceiling mounting.
- Electronic power supply: with DALI dimmable, Switch DIM or non-dimmable options (depending on light source).
- Materials: injection-moulded aluminium head, aluminium or polymer body, pure aluminium reflectors.
- Compliant to EN60598-1 standard and other specific regulations.

Picto track

White
○

Black
●

Silver
●





Picto Color map

White
○

Black
●

Silver
●

Accessory-holder colour

○ White



● Black



Projector corresponding colour

Black
●



White
○



Silver
●











Picto 70 LED

White ○ Black ● Silver ●

LED non dimmable

W	Weight	Beam	Flux	CCT	Color
18 W	0,75 kg	18°	704 lm	3000 K	○
					●
					●
			757 lm	4000 K	○
					●
					●
		38°	729 lm	3000 K	○
					●
					●
			832 lm	4000 K	○
					●
					●

Vertical

Code
M222233
M222243
M222263
M222333
M222343
M222363
M222433
M222443
M222463
M222533
M222543
M222563

Horizontal

Code
M222633
M222643
M222663
M222733
M222743
M222763
M222833
M222843
M222863
M222933
M222943
M222963

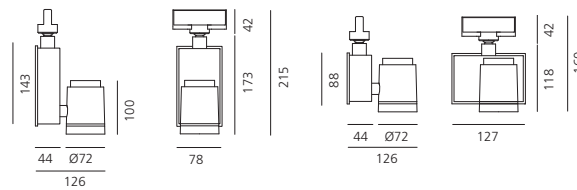

IP20 ⊕
850°

220/240Vac 50/60Hz electronic ballast included.

Picto 70 LED 18°

LED	luminaire			
	15 W	15 W	18 W	18 W
Power	15 W	15 W	18 W	18 W
Flux	1160 lm	1320 lm	704 lm	757 lm
CCT	3000 K	4000 K	3000 K	4000 K
CRI	=82 (typ.)			
Color tolerance	MacAdam 4SDCM			
Service life	L70(6K) > 36000h			
Beam			18°	18°
Efficiency			61%	61%
Efficacy	77 lm/W	88 lm/W	39 lm/W	42 lm/W

18 W

3000 K α=18° 4000 K α=18°

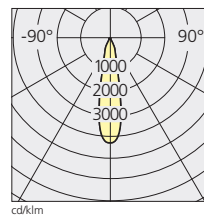

H m	Ø m	EMax lux	EM lux	H m	Ø m	EMax lux	EM lux
1	0,32	3156	1989	1	0,32	3393	2138
2	0,64	789	497	2	0,64	848	535
3	0,96	351	221	3	0,96	377	238
4	1,28	197	124	4	1,28	212	134
5	1,60	126	80	5	1,60	136	86

Picto 70 LED 38°

LED	luminaire			
	15 W	15 W	18 W	18 W
Power	15 W	15 W	18 W	18 W
Flux	1160 lm	1320 lm	729 lm	832 lm
CCT	3000 K	4000 K	3000 K	4000 K
CRI	=82 (typ.)			
Color tolerance	MacAdam 4SDCM			
Service life	L70(6K) > 36000h			
Beam			38°	38°
Efficiency			63%	63%
Efficacy	77 lm/W	88 lm/W	41 lm/W	46 lm/W

18 W



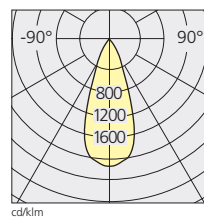















3000 K α=38° 4000 K α=38°



H m	Ø m	EMax lux	EM lux	H m	Ø m	EMax lux	EM lux
1	0,69	1609	1020	1	0,69	1837	1164
2	1,38	402	255	2	1,38	459	291
3	2,07	179	113	3	2,07	204	129
4	2,75	101	64	4	2,75	115	73
5	3,44	64	41	5	3,44	73	47

Picto 70 HIT

White  Black  Silver 

HIT-TC-CE (GU6,5)					Vertical	Horizontal
W	Weight	Beam	Flux	Color	Code	Code
20 W	0,75 kg	14°	1700 lm		M223433SP	M224033SP
					M223443SP	M224043SP
					M223463SP	M224063SP
		24°	1700 lm		M223433MFL	M224033MFL
					M223443MFL	M224043MFL
					M223463MFL	M224063MFL
42°	1700 lm		M223433FL	M224033FL		
			M223443FL	M224043FL		
			M223463FL	M224063FL		
35 W		14°	3400 lm		M223533SP	M224133SP
					M223543SP	M224143SP
					M223563SP	M224163SP
		24°	3400 lm		M223533MFL	M224133MFL
					M223543MFL	M224143MFL
					M223563MFL	M224163MFL
42°	3400 lm		M223533FL	M224133FL		
			M223543FL	M224143FL		
			M223563FL	M224163FL		

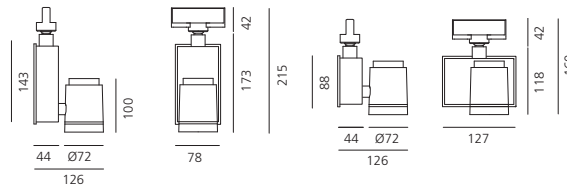

IP20  850° 

220/240Vac 50/60Hz electronic ballast included.

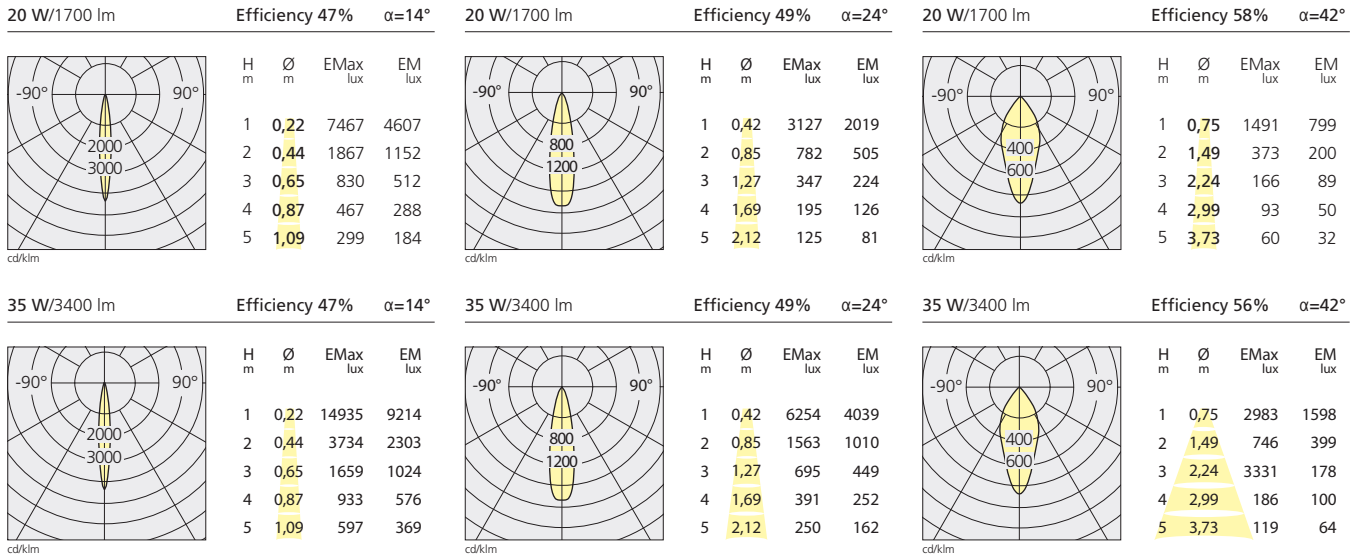

HIPAR51-CE-P (GX10)				
W	Weight	Color	Code	Code
35 W	0,62 kg		M223133	M223733
			M223143	M223743
			M223163	M223763

Picto 100 LED

White ○ Black ● Silver ●

LED Vertical

W	Weight	Beam	Flux	CCT	Color
23 W	1,20 kg	24°	1169 lm	3000 K	○
					●
					●
		42°	1211 lm	3000 K	○
					●
					●
1296 lm	4000 K	○			
		●			
		●			

Non dimmable

Code
M229533
M229543
M229563
M229633
M229643
M229663
M229733
M229743
M229763
M229833
M229843
M229863

Dali dimmable

Code
M236633
M236643
M236663
M236733
M236743
M236763
M236833
M236843
M236863
M236933
M236943
M236963



LED Horizontal

W	Weight	Beam	Flux	CCT	Color
23 W	1,20 kg	24°	1169 lm	3000 K	○
					●
					●
		42°	1211 lm	3000 K	○
					●
					●
1296 lm	4000 K	○			
		●			
		●			

Non dimmable

Code
M236233
M236243
M236263
M236333
M236343
M236363
M236433
M236443
M236463
M236533
M236543
M236563

Dali dimmable

Code
M237033
M237043
M237063
M237133
M237143
M237163
M237233
M237243
M237263
M237333
M237343
M237363



IP20 850° -90° 90° 355°

220/240Vac 50/60Hz electronic ballast included.

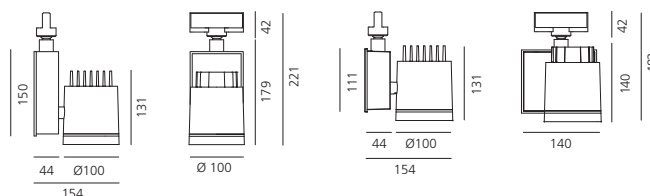

Picto 100 LED 24°

LED	luminaire			
19 W	19 W	23 W	23 W	
1916 lm	2049 lm	1169 lm	1250 lm	
3000 K	4000 K	3000 K	4000 K	
CRI =82 (typ.)				
Color tolerance MacAdam 4SDCM				
Service life L70(6K) > 36000h				
Beam		24°	24°	
Efficiency		61%	61%	
Efficacy	100 lm/W	108 lm/W	51 lm/W	54 lm/W

23 W	3000 K	α=24°	4000 K	α=24°
	H	Ø	EMax	EM
	m	m	lux	lux
	1	0,40	5162	3200
	2	0,81	1291	805
	3	1,21	574	358
4	1,61	323	201	
5	2,02	206	129	

Picto 100 LED 42°

LED	luminaire			
19 W	19 W	23 W	23 W	
1985 lm	2124 lm	1211 lm	1296 lm	
3000 K	4000 K	3000 K	4000 K	
CRI =82 (typ.)				
Color tolerance MacAdam 4SDCM				
Service life L70(6K) > 36000h				
Beam		42°	42°	
Efficiency		61%	61%	
Efficacy	104 lm/W	111 lm/W	53 lm/W	56 lm/W

23 W	3000 K	α=42°	4000 K	α=42°
	H	Ø	EMax	EM
	m	m	lux	lux
	1	0,75	2671	1702
	2	1,50	668	425
	3	2,26	297	189
4	3,01	167	106	
5	3,76	107	68	

Picto 100 HIT

White ○ Black ● Silver ●

HIT-TC-CE (G8,5)

Vertical

Horizontal

W	Weight	Beam	Flux	Color	Code	Code		
35 W	1,00 kg	12°	3500 lm	○	M224233SP	M224733SP		
				●	M224243SP	M224743SP		
				●	M224263SP	M224763SP		
		22°	3500 lm	○	M224233MFL	M224733MFL		
				●	M224243MFL	M224743MFL		
				●	M224263MFL	M224763MFL		
		28°	3500 lm	○	M224233FL	M224733FL		
				●	M224243FL	M224743FL		
				●	M224263FL	M224763FL		
		38°	3500 lm	○	M224233WFL	M224733WFL		
				●	M224243WFL	M224743WFL		
				●	M224263WFL	M224763WFL		
		70 W	1,00 kg	12°	6900 lm	○	M224333SP	M224833SP
						●	M224343SP	M224843SP
						●	M224363SP	M224863SP
22°	6900 lm			○	M224333MFL	M224833MFL		
				●	M224343MFL	M224843MFL		
				●	M224363MFL	M224863MFL		
28°	6900 lm			○	M224333FL	M224833FL		
				●	M224343FL	M224843FL		
				●	M224363FL	M224863FL		
38°	6900 lm			○	M224333WFL	M224833WFL		
				●	M224343WFL	M224843WFL		
				●	M224363WFL	M224863WFL		



IP20
850° -90° / 90° / 355°

220/240Vac 50/60Hz electronic ballast included.

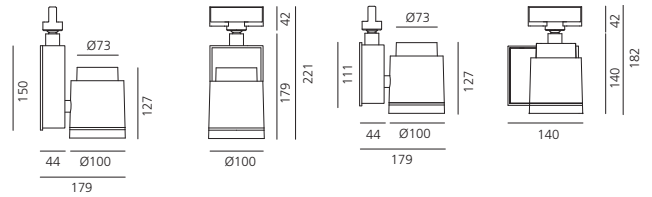

35 W/3500 lm Efficiency 54% α=12°

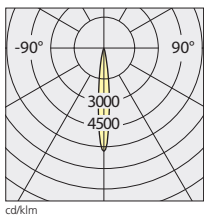

H m	Ø m	EMax lux	EM lux
1	0,21	22516	14438
2	0,42	5629	3609
3	0,63	2502	1604
4	0,84	1407	902
5	1,05	901	578

35 W/3500 lm Efficiency 62% α=22°

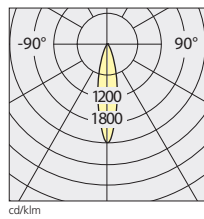

H m	Ø m	EMax lux	EM lux
1	0,40	8505	5126
2	0,81	2126	1282
3	1,21	945	570
4	1,61	532	320
5	2,02	340	205

35 W/3500 lm Efficiency 59% α=28°

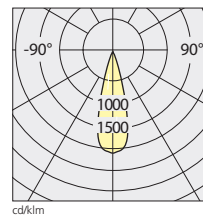

H m	Ø m	EMax lux	EM lux
1	0,51	7477	4963
2	1,03	1869	1241
3	1,54	831	551
4	2,05	467	310
5	2,56	299	199

35 W/3500 lm Efficiency 63% α=38°

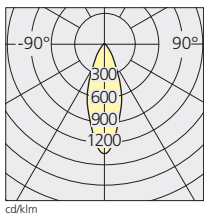

H m	Ø m	EMax lux	EM lux
1	0,66	4520	2549
2	1,32	1130	637
3	1,97	502	283
4	2,63	282	159

70 W/6900 lm Efficiency 54% α=12°

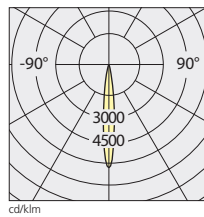

H m	Ø m	EMax lux	EM lux
1	0,21	44389	28463
2	0,42	11097	7116
3	0,63	4932	3163
4	0,84	2774	1779
5	1,05	1776	1139

70 W/6900 lm Efficiency 62% α=22°

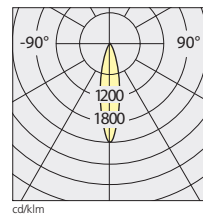

H m	Ø m	EMax lux	EM lux
1	0,40	16766	10106
2	0,81	44192	2527
3	1,21	1863	1123
4	1,61	1048	632
5	2,02	671	404

70 W/6900 lm Efficiency 59% α=28°

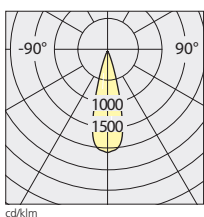

H m	Ø m	EMax lux	EM lux
1	0,51	14741	9784
2	1,03	3685	2446
3	1,54	1638	1087
4	2,05	921	612
5	2,56	590	391

70 W/6900 lm Efficiency 63% α=38°

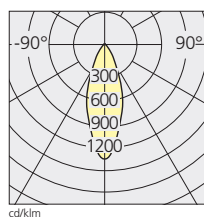





H m	Ø m	EMax lux	EM lux
1	0,66	8911	5052
2	1,32	2228	1256
3	1,97	990	558
4	2,63	557	314

White
○Black
●Silver
●

Accessories Picto 70

		Projector	Color*	Code
	Accessory-holder + asymmetric diffuser (black)	○	●	M083037
		●	○	M083017
		●	●	M083037
	Accessory-holder + adjustable dowsers (black)	○	●	M082837
		●	○	M082817
		●	●	M082837
	Accessory-holder + projection lens to control shape of beam	○	●	M083937
		●	○	M083917
		●	●	M083937
	Accessory-holder + projection lens for gobo Gobo to be ordered separately	○	●	M083837
		●	○	M083817
		●	●	M083837
	Customized gobo in silk-screen printed glass Ø 37,5 mm Thickness 1,1 mm Light fitting min Ø 10 mm max Ø 20 mm			M080800
	Accessory for ceiling installation	○		L176320
		●		L176330
		●		L176370

Accessories Picto 100

		Projector	Color*	Code
	Accessory-holder + asymmetric diffuser (black)	○	●	M082737
		●	○	M082717
		●	●	M082737
	Accessory-holder + adjustable dowsers (black)	○	●	M082637
		●	○	M082617
		●	●	M082637
	Accessory-holder + anti-dazzle louvre	○	●	M081737
		●	○	M081717
		●	●	M081737
	UV Filter			M080545
	Accessory for ceiling installation	○		L176320
		●		L176330
		●		L176370



Picto 125 LED track tunable white

White ○ Black ● Silver ●

						manual adjustment	Dali 8
W	Weight	Beam	Flux	CCT	Color	Code	Code
35 W	2,60 kg	16°	1335 lm	2900 K-	○	M278033	M278233
				5500 K	●	M278043	M278243
					●	M278063	M278263
		36°	1238 lm	2900 K-	○	M278133	M278333
				5500 K	●	M278143	M278343
					●	M278163	M278363



220/240Vac 50/60Hz electronic ballast included.

IP20 ⊕ -90° 90° 355°
850°

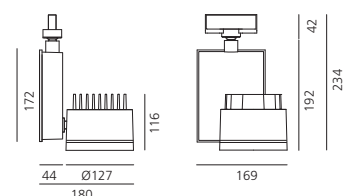

Picto 125 LED TW 16°

LED	luminaire
Power	30 W / 35 W
Flux	2428 lm / 1335 lm
CCT	2900 K-5500 K / 2900 K-5500 K
CRI	>93 (min.)
Color tolerance	
Service life	
Beam	16°
Efficiency	55%
Efficacy	81 lm/W / 38 lm/W

35 W 2900 K-5500 K α=16°

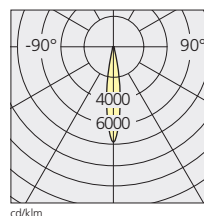

H _m	Ø _m	EMax _{lux}	EM _{lux}
1	0,28	10259	4997
2	0,57	2565	1249
3	0,85	1140	555
4	1,14	641	312
5	1,44	410	200

Picto 125 LED TW 36°

LED	luminaire
Power	30 W / 35 W
Flux	2428 lm / 1238 lm
CCT	2900 K-5500 K / 2900 K-5500 K
CRI	>93 (min.)
Color tolerance	
Service life	
Beam	36°
Efficiency	51%
Efficacy	81 lm/W / 35 lm/W

35 W 2900 K-5500 K α=36°

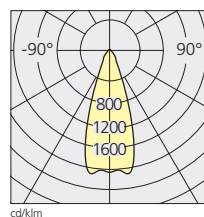

H _m	Ø _m	EMax _{lux}	EM _{lux}
1	0,67	2524	1104
2	1,33	631	276
3	2,00	280	123
4	2,66	158	69
5	3,33	101	44

TW®

Artemide Tunable White

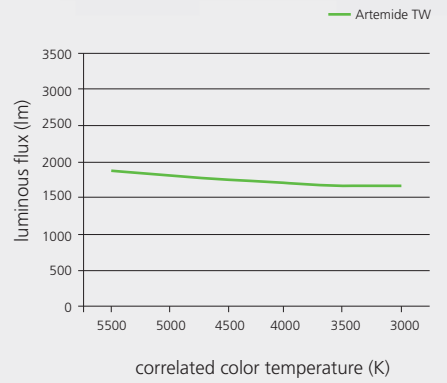
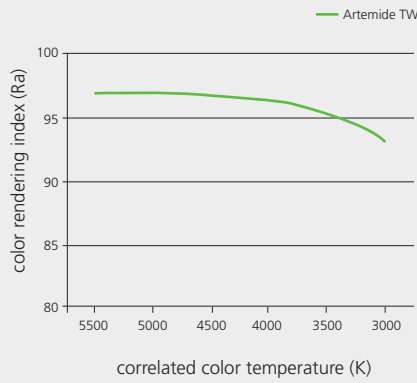
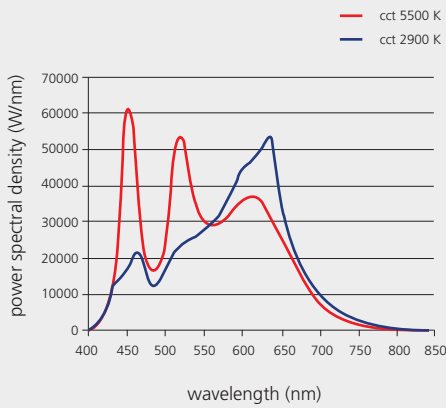
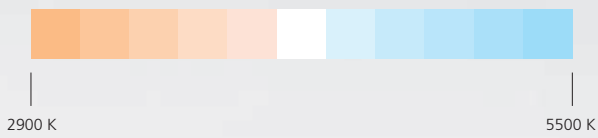

Picto 125 LED track stable white

White ○ Black ● Silver ●

						non dimmable	Dali dimmable
W	Weight	Beam	Flux	CCT	Color	Code	Code
35 W	2,60 kg	16°	2072 lm	3000 K	○	M237433	M243633
					●	M237443	M243643
					●	M237463	M243663
			2217 lm	4000 K	○	M237533	M243733
					●	M237543	M243743
					●	M237563	M243763
		36°	1899 lm	3000 K	○	M237633	M243833
					●	M237643	M243843
					●	M237663	M243863
			2032 lm	4000 K	○	M237733	M243933
					●	M237743	M243943
					●	M237763	M243963



IP20 ⊕ 850° -90° 90° 355°

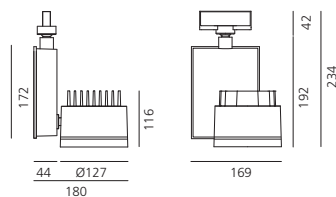

220/240Vac 50/60Hz electronic ballast included.

Picto 125 LED 16°

LED	luminaire			
	31 W	31 W	35 W	35 W
Power	31 W	31 W	35 W	35 W
Flux	3454 lm	3695 lm	2072 lm	2217 lm
CCT	3000 K	4000 K	3000 K	4000 K
CRI	=80 (min.)			
Color tolerance	MacAdam 3SDCM			
Service life	L70(6K) > 36000h			
Beam	16°		16°	
Efficiency	60%		60%	
Efficacy	111 lm/W	119 lm/W	59 lm/W	63 lm/W

35 W	3000 K		α=16°		4000 K		α=16°	
	H m	Ø m	EMax lux	EM lux	H m	Ø m	EMax lux	EM lux
1	0,28		15922	9923	1	0,28	17037	10618
2	0,57		3981	2481	2	0,57	4259	2654
3	0,85		1769	1103	3	0,85	1893	1180
4	1,14		995	620	4	1,14	1065	664
5	1,42		637	397	5	1,42	681	425

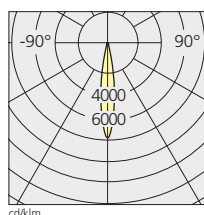

Picto 125 LED 36°

LED	luminaire			
	31 W	31 W	35 W	35 W
Power	31 W	31 W	35 W	35 W
Flux	3454 lm	3695 lm	1899 lm	2032 lm
CCT	3000 K	4000 K	3000 K	4000 K
CRI	=80 (min.)			
Color tolerance	MacAdam 3SDCM			
Service life	L70(6K) > 36000h			
Beam	36°		36°	
Efficiency	55%		55%	
Efficacy	111 lm/W	119 lm/W	54 lm/W	55 lm/W

35 W	3000 K		α=36°		4000 K		α=36°	
	H m	Ø m	EMax lux	EM lux	H m	Ø m	EMax lux	EM lux
1	0,67		3872	2592	1	0,67	4143	2773
2	1,33		968	648	2	1,33	1036	693
3	2,00		430	288	3	2,00	460	308
4	2,66		242	162	4	2,66	259	173
5	3,33		155	104	5	3,33	166	111

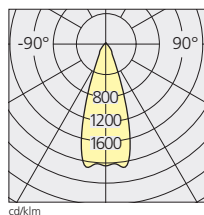

Picto 125 HIT track

White ○ Black ● Silver ●

HIT-CE (G12)

W	Weight	Beam	Flux	Color	Code
35 W	2,40 kg	22°	3500 lm	○	M225433MFL
				●	M225443MFL
				●	M225463MFL
		38°	3500 lm	○	M225433WFL
				●	M225443WFL
				●	M225463WFL
		50°	3500 lm	○	M225433VWFL
				●	M225443VWFL
				●	M225463VWFL
70 W	2,40 kg	22°	6300 lm	○	M225533MFL
				●	M225543MFL
				●	M225563MFL
		38°	6300 lm	○	M225533WFL
				●	M225543WFL
				●	M225563WFL
		50°	6300 lm	○	M225533VWFL
				●	M225543VWFL
				●	M225563VWFL
150 W	2,40 kg	22°	14000 lm	○	M225633MFL
				●	M225643MFL
				●	M225663MFL
		38°	14000 lm	○	M225633WFL
				●	M225643WFL
				●	M225663WFL
		50°	14000 lm	○	M225633VWFL
				●	M225643VWFL
				●	M225663VWFL



IP20 85° -90° 90° 355°

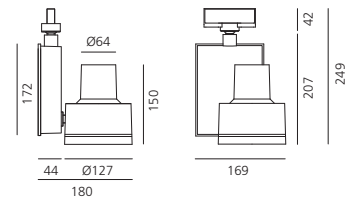

220/240Vac 50/60Hz electronic ballast included.

35 W/3500 lm

Efficiency 62% α=22°

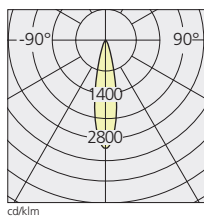

H m	Ø m	EMax lux	EM lux
1	0,41	10056	6392
2	1,82	2514	1598
3	1,23	1117	710
4	1,64	628	399
5	2,05	402	256

35 W/3500 lm

Efficiency 58% α=38°

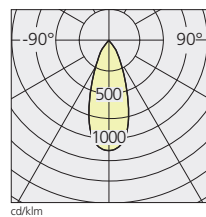

H m	Ø m	EMax lux	EM lux
1	0,71	3878	2353
2	1,42	969	588
3	2,12	431	261
4	2,83	242	147
5	3,54	155	94

35 W/3500 lm

Efficiency 59% α=50°

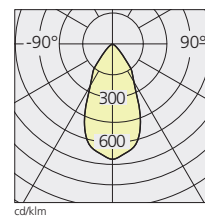

H m	Ø m	EMax lux	EM lux
1	0,95	2409	1377
2	1,90	602	344
3	2,85	268	153
4	3,79	151	86
5	4,74	96	55

70 W/6300 lm

Efficiency 64% α=22°

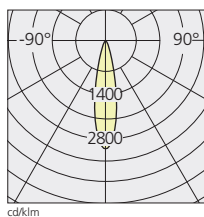

H m	Ø m	EMax lux	EM lux
1	0,40	18568	11672
2	0,80	4642	2918
3	1,20	2063	1297
4	1,60	1160	730
5	2,00	743	467

70 W/6600 lm

Efficiency 61% α=38°

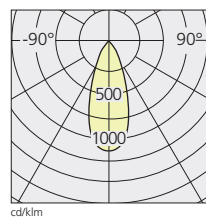

H m	Ø m	EMax lux	EM lux
1	0,70	7318	4439
2	1,39	1830	1110
3	2,09	813	493
4	2,78	457	277
5	3,48	293	178

70 W/6600 lm

Efficiency 63% α=50°

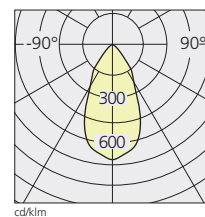

H m	Ø m	EMax lux	EM lux
1	0,95	4347	2454
2	1,90	1087	613
3	2,86	483	273
4	3,81	272	153
5	4,76	174	98

150 W/14000 lm

Efficiency 62% α=22°

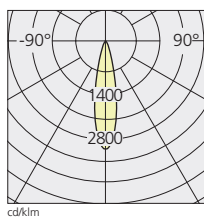

H m	Ø m	EMax lux	EM lux
1	0,41	40224	25567
2	0,82	10056	6392
3	1,23	4469	2841
4	1,64	2514	1598
5	2,05	1609	1023

150 W/14000 lm

Efficiency 58% α=38°

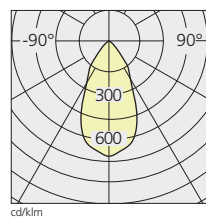

H m	Ø m	EMax lux	EM lux
1	0,71	15511	9411
2	1,42	3878	2353
3	2,12	1723	1046
4	2,83	969	588
5	3,54	620	376

150 W/14000 lm

Efficiency 59% α=50°

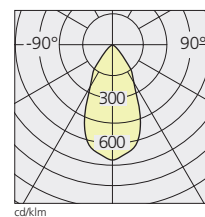

H m	Ø m	EMax lux	EM lux
1	0,95	9636	5507
2	1,90	2409	1377
3	2,85	1071	612
4	3,79	602	344
5	4,74	385	220

White
○

Black
●

Silver
●

Accessories*

		Projector	Color*	Code
	Accessory-holder + asymmetric diffuser (black)	○	●	M083137
		●	○	M083117
		●	●	M083137
	Accessory-holder + adjustable dowsers (black)	○	●	M082937
		●	○	M082917
		●	●	M082937
	Accessory-holder + anti-dazzle louvre	○	●	M083337
		●	○	M083317
		●	●	M083337
	Accessory-holder + IR filter	○	●	M083537
		●	○	M083517
		●	●	M083537
	Accessory-holder + lens for elliptical emission	○	●	M083437
		●	○	M083417
		●	●	M083437
	Accessory-holder + chromatic filter Warmtone	○	●	M083637
		●	○	M083617
		●	●	M083637
	Accessory-holder + chromatic filter Coldtone	○	●	M083737
		●	○	M083717
		●	●	M083737
	UV Filter			M080535
	Accessory for ceiling installation	○		L176320
		●		L176330
		●		L176370



External three-circuit track

White
○

Black
●

Aluminium
●

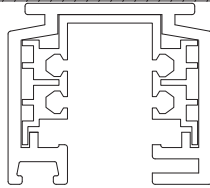

- Three-circuit track for surface mounting.
- Extruded aluminium profile in white, black or aluminium finish.
- Supplied in lengths of up to 4m, cut to measure.
- 2 versions: standard version with 5 conductors (1 earth, 1 neutral, 3 phases) each with a 2.5mm² section, or Dali version with 2 additional conductors allowing dimming of lights fitted with Dali dimmable control gear.
- Maximum intensity: 16a across the 3 circuits.
- Track is pre-cut every 33cm for fixing.
- Wide range of accessories, power supply components and electrical and mechanical connectors.

External three-circuit track



1000 mm
1,00 kg

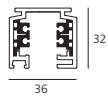

2000 mm
2,00 kg

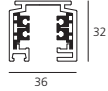

3000 mm
3,00 kg

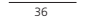

4000 mm
4,00 kg

Color

-
-
-
-
-
-
-
-
-

Standard

Code

- L170020
- L170030
- L170070
- L170120
- L170130
- L170170
- L170220
- L170230
- L170270
- L170320
- L170330
- L170370

Dali

Code

- L170021
- L170031
- L170071
- L170121
- L170131
- L170171
- L170221
- L170231
- L170271
- L170321
- L170331
- L170371

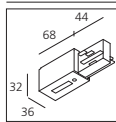

Power supply end cap
Earth conductor
on the left.

-
-
-

- L170620
- L170630
- L170670

- L170621
- L170631
- L170671

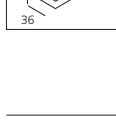

Power supply end cap
Earth conductor
on the right.

-
-
-

- L170720
- L170730
- L170770

- L170721
- L170731
- L170771

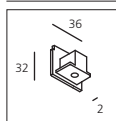

Closure end cap

-
-
-

- L171620
- L171630
- L171670

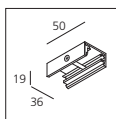

Clip for steel cables
or pendant coupler

-
-
-

- L171720
- L171730
- L171770

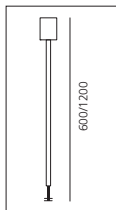

Stem Ø13 mm.
Can be cut to measure.
For use with pendant clip
or pendant coupler
(on request).



-
-

- L170420
- L170430

Suspension cables

- L. 1.500 mm Eutrac
- L. 3.000 mm Eutrac
- L. 6.200 mm Eutrac

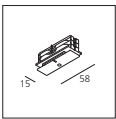
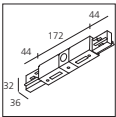
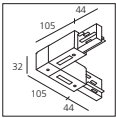
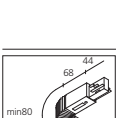
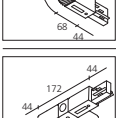
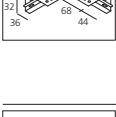
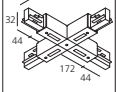
- L176000
- L176100
- L176200

Joints		Standard	Dali
	Color	Code	Code
	Recessed joint	L170920	L170921
	<input type="radio"/>	L170930	L170931
	<input type="radio"/>	L170970	L170971
	Linear joint	L171020	L171021
	<input type="radio"/>	L171030	L171031
	<input type="radio"/>	L171070	L171071
	90° joint Internal earth conductor.	L171120	L171121
	<input type="radio"/>	L171130	L171131
	<input type="radio"/>	L171170	L171171
	90° joint External earth conductor.	L171220	L171221
	<input type="radio"/>	L171230	L171231
	<input type="radio"/>	L171270	L171271
	Flexible joint	L171520	L171521
	<input type="radio"/>	L171530	L171531
	<input type="radio"/>		
	3-way joint Earth conductor on left.	L171820	L171821
	<input type="radio"/>	L171830	L171831
	<input type="radio"/>	L171870	L171871
	3-way joint Earth conductor on right.	L171320	L171321
	<input type="radio"/>	L171330	L171331
	<input type="radio"/>	L171370	L171371
	4-way joint	L171420	L171421
	<input type="radio"/>	L171430	L171431
	<input type="radio"/>	L171470	L171471

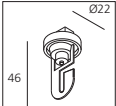
Accessories		Standard	Dali
	Color	Code	Code
	Universal adapter 230/240V - 16A	L172020	L172021
	<input type="radio"/>	L172030	L172031
	Universal hook Maximum load 10 kg	L173420	
	<input type="radio"/>	L173430	

Recessed three-circuit track

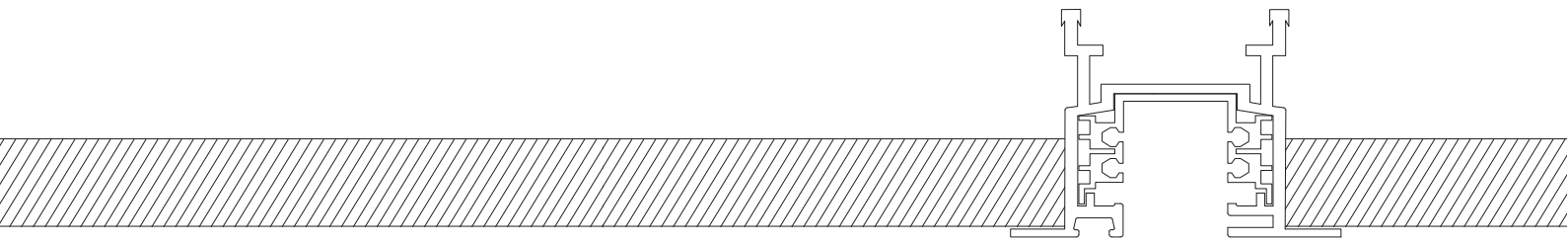

- Three-circuit track for recess mounting.
- Extruded aluminium profile in white, black or aluminium finish.
- Supplied in lengths of up to 4m, cut to measure.
- 2 versions: standard version with 5 conductors (1 earth, 1 neutral, 3 phases) each with a 2.5mm² section, or Dali version with 2 additional conductors allowing dimming of lights fitted with Dali dimmable control gear.
- Maximum intensity: 16a across the 3 circuits.
- Track is pre-cut every 33cm for fixing.
- Wide range of accessories, power supply components and electrical and mechanical connectors.

Recessed three-circuit track



2000 mm
2,30 kg

3000 mm
3,50 kg

4000 mm
4,60 kg

Color



Standard

Code

L172620

L172720

L172820

Dali

Code

L172621

L172721

L172821

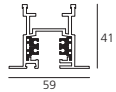

40xL

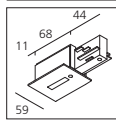

Power supply end cap
Earth conductor on left.



L176420

L176421

Power supply end cap
Earth conductor on right.



L176520

L176521

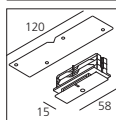

Recessed joint



L173220

L173221

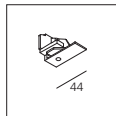

Closure end cap



L173320

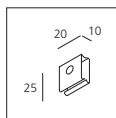

Clip for suspension cable
(6 pieces)

L173400

Accessories



Universal adapter
230/240V - 16A

Color



Standard

Code

L172020

L172030

Dali

Code

L172021

L172031

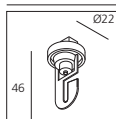

Universal hook
Maximum load 10 kg



L173420

L173430

Installation diagrams

Load of tracks with spotlights in relation to fixing points (includes the weight of the track)

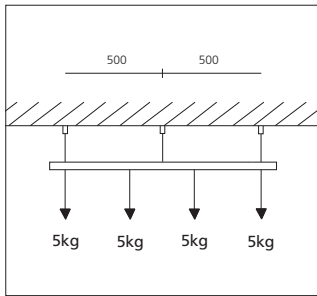

- Three-circuit track for pendant mounting with fixing points every 0.5m. (Can also be used for recessed installation).

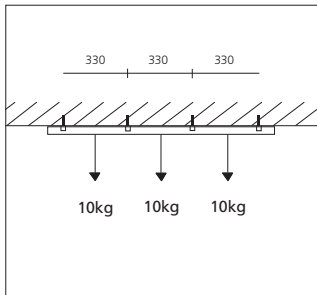

- Three-circuit track for ceiling mounting with fixing points every 0.33m.

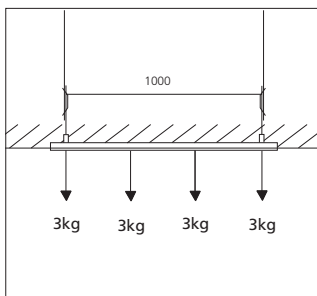

- Three-circuit track for recessed installation with fixing points every metre. (Can also be used for pendant mounting).

Earth conductor diagrams

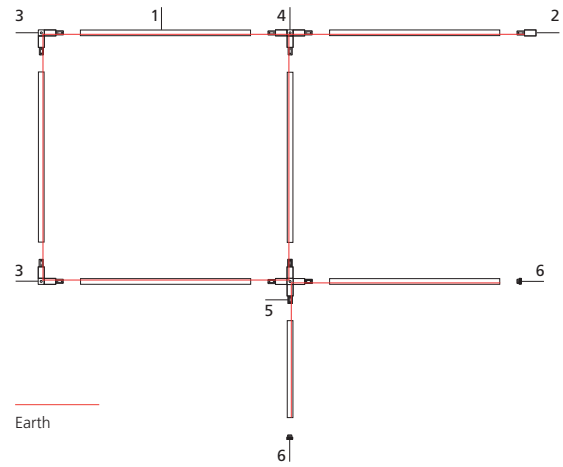

- | | |
|--|---|
| 1 Standard three-circuit track. | 4 3-way joint, earth conductor on left. |
| 2 Power supply end cap, earth conductor on left. | 5 4-way joint. |
| 3 90° joint, internal earth conductor. | 6 Closure end cap. |

Electrical diagram for alternating current 230V (220-240V)

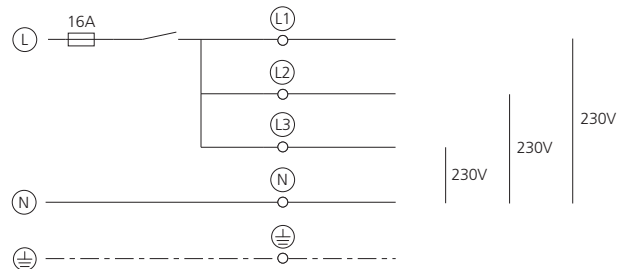

Maximum W allowed: 3600W (max 16A total).
 The load can be distributed over the 3 circuits as required.
 Protection fuse: 1x16A.
 Power supply cable section: min 3x1.5mm² - max 3x2.5mm².

Caelum

Ernesto Gismondi
2013





Caelum

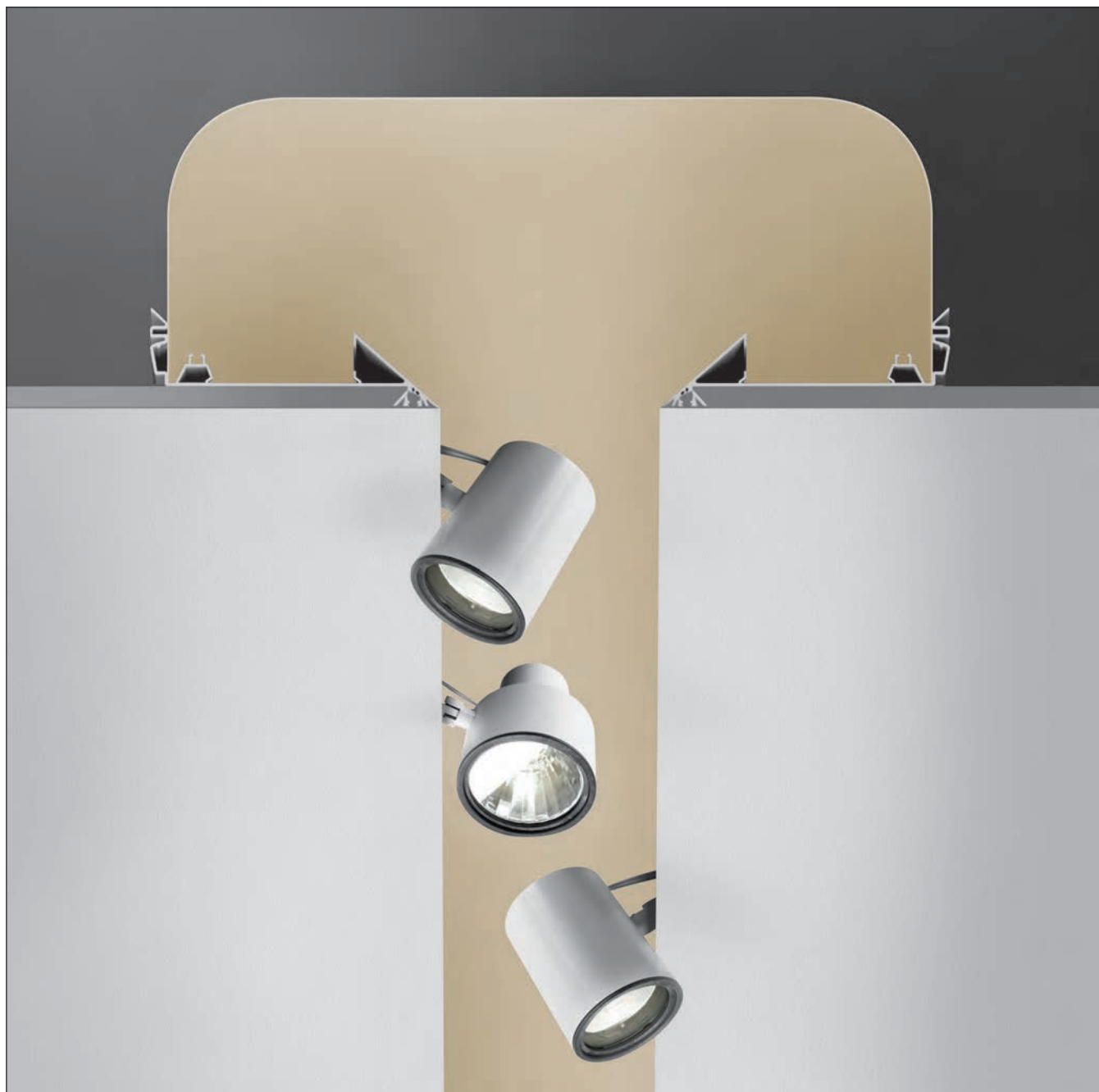

- Caelum is designed to provide a versatile lighting solution for the retail sector. It is a highly flexible, multi-functional system, with a high aesthetic and exceptionally high performance.
- Caelum is a modular lighting system with an open recessed profile channel, which integrates perfectly with the architectural design. It consists of 4 main elements:

Trimless recessed structural modules in various lengths; channel apertures: 86 mm and 140 mm;

Spotlight kits for accent lighting, using LED, HIT and 12V halogen lamps;

Optional covers to delineate the channel. The spotlight kits are available in 2 sizes: Ø 90 mm and Ø 120 mm (diameter of the optical assembly) and are provided with a swivel arm which allows total concealment of the spotlight or, if open, allows the partial or total extraction of the spotlight from the channel.

- A double hinge system provides a high degree of regulation of the beam direction.
 - The spotlights are provided with an electronic power supply. The LED spotlights are available with 1000, 2500 and 3000 lumen power, in warm white or neutral (3000K, 4000K).
- Depending on the size, the HIT spotlights are available for the following power supplies: 20W-35W (G8.5), 35W-70W (G12).
 - The largest size spotlight is also available in a 12V QR111 100W max halogen version.
 - The extruded elements are installed along both edges of the ceiling cut, creating a channel that can be finished with an optional top cover.

Caelum color

White Black Blue Gold
○ ● ● ●



Caelum installation

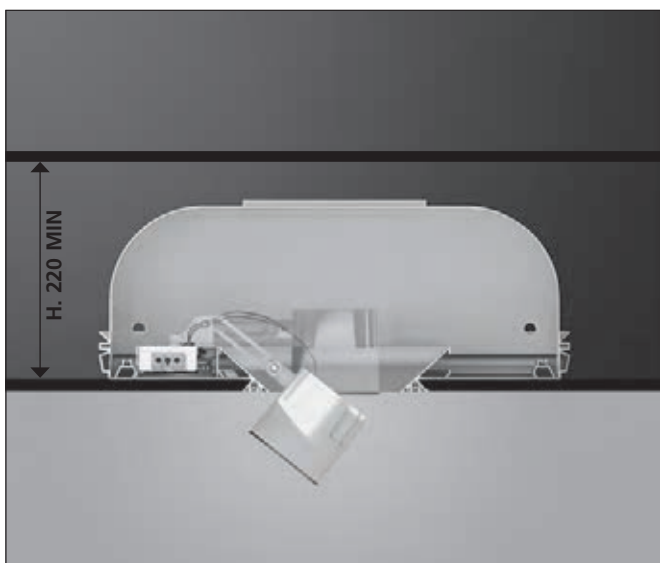

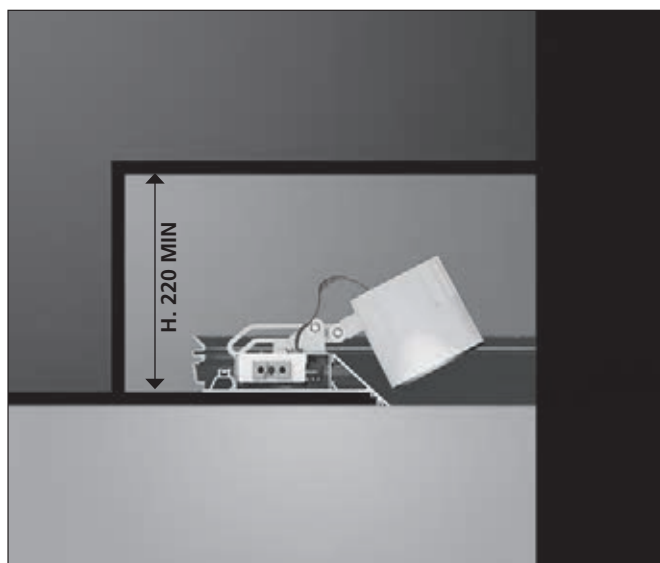
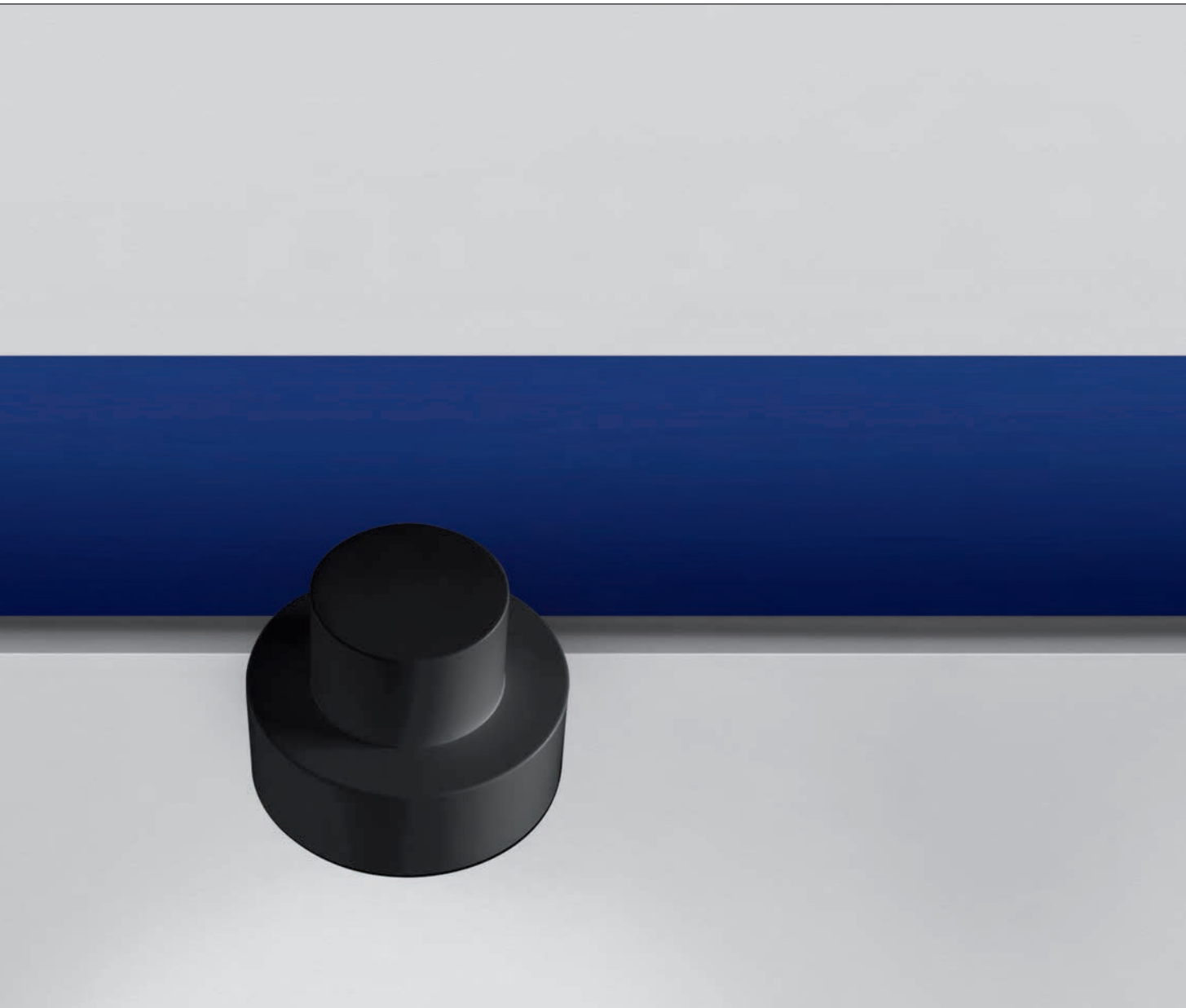

Special application without Carter against the wall.

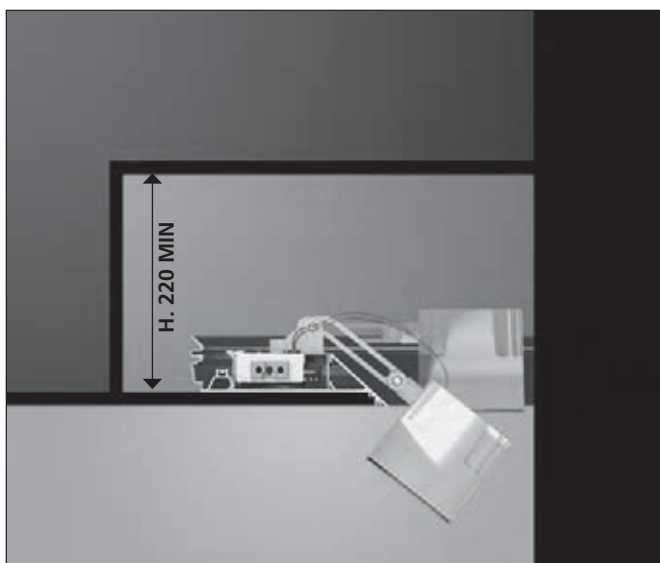

Special application without Carter against the wall.

Caelum spotlights



Spot (SP)
 $10^\circ < \text{beam angle} \leq 20^\circ$
 For highlighting small objects.



Medium flood (MFL)
 $20^\circ < \text{beam angle} \leq 30^\circ$
 Standard feature for accent lighting of any type of object.



Flood (FL)
 $30^\circ < \text{beam angle} \leq 40^\circ$
 For accent lighting of large objects.



Wide flood (WFL)
 $40^\circ < \text{beam angle} \leq 60^\circ$
Very Wide flood (VWFL)
 Beam angle $> 30^\circ$
 For diffused lighting of an area or to accentuate the presentation of products.

		SP	MFL	FL	WFL	VWFL
Caelum 90	LED		•		•	
	HIT	•	•	•	•	
Caelum 120	LED	•		•		
	HALO	•			•	•
	HIT G12		•	•	•	
	HIT GX8.5		•		•	•



LED

HIT

HALO



Caelum structural components

Carter for false ceiling



Linear profiles
500 mm long
600 mm long
700 mm long

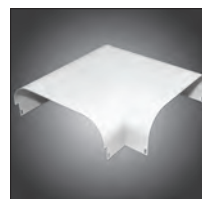

Left inner profile
For joining two linear profiles
on the same level.

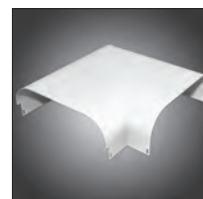

Right inner profile
For joining two linear profiles
on the same level.



End cap

Aluminium trim profiles



Linear aluminium trim
profiles
500 mm long
1000 mm long
2000 mm long
3000 mm long



90° inner coupling
For joining two trim profiles
on the same level.

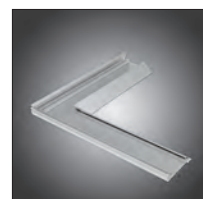

90° outer coupling
For joining two trim profiles
on the same level.



Closing end caps

Caelum configuration

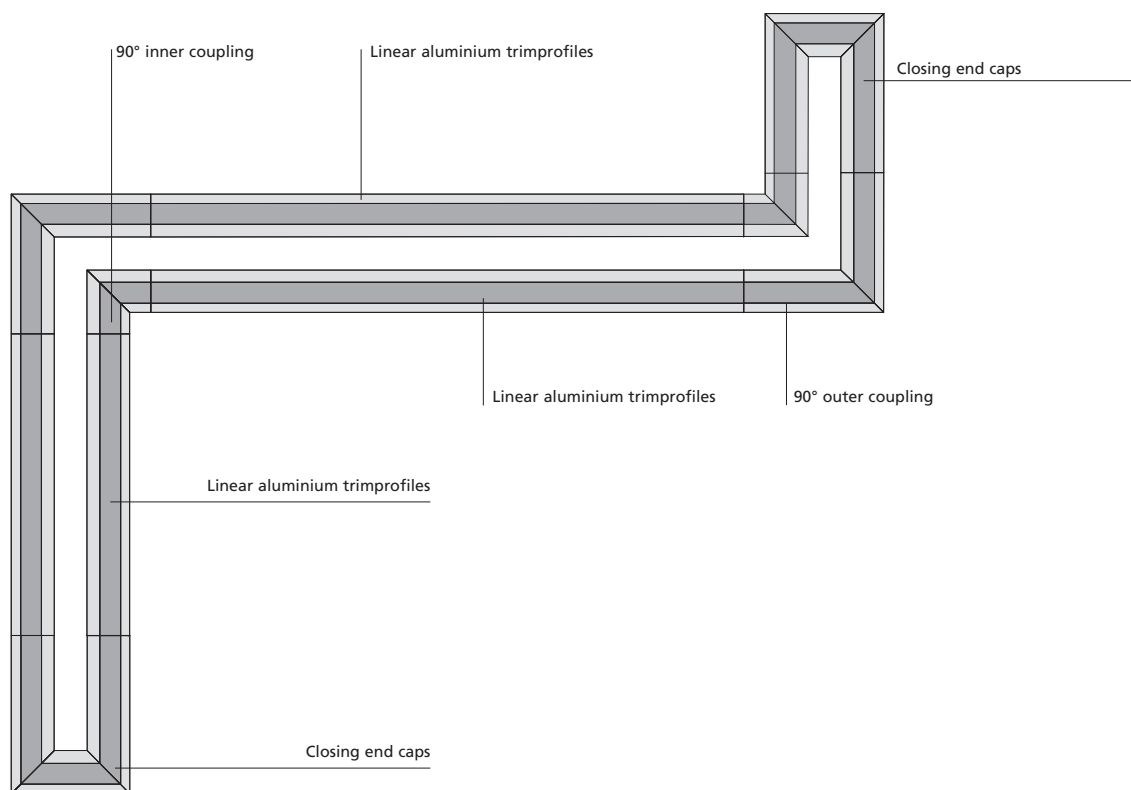
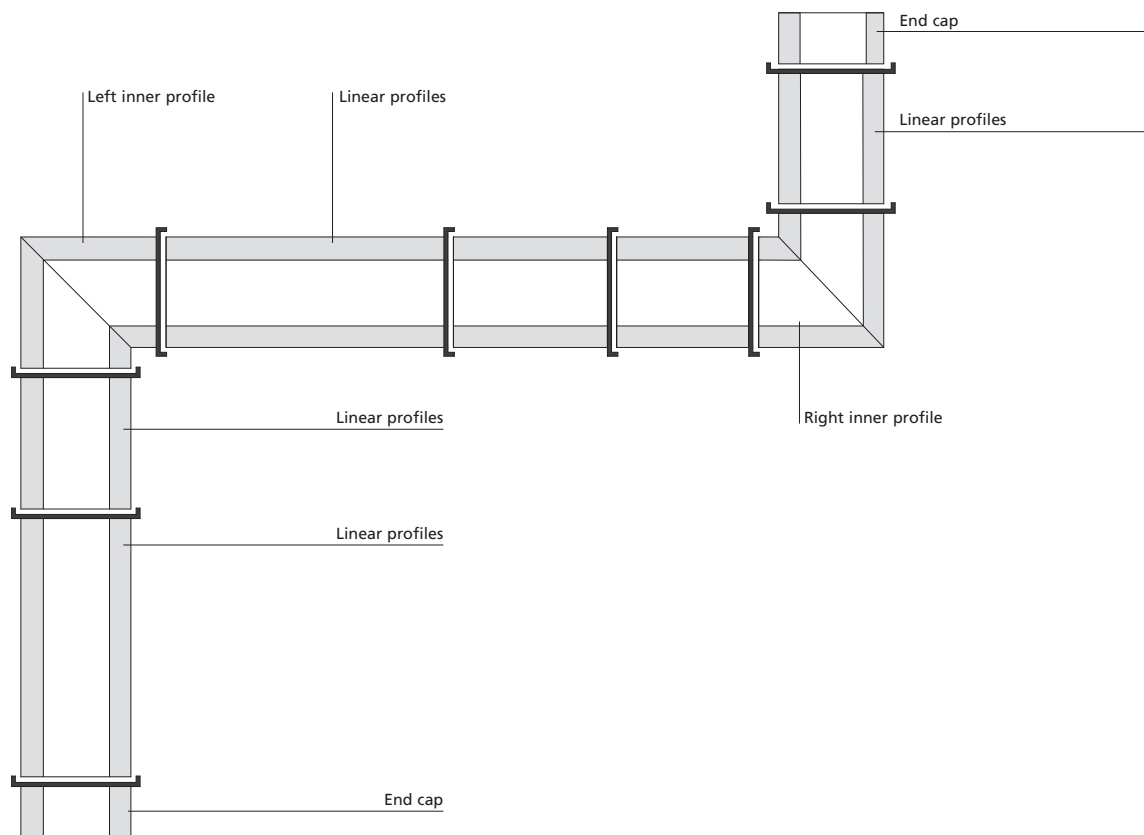

Caelum profile

White Black Blue Gold
 ○ ● ● ●

Profile

Length	Weight	Color	Code
500 mm	3,30 kg	○	M282720
		●	M282710
		●	M282730
		●	M282750
600 mm	3,90 kg	○	M282820
		●	M282810
		●	M282830
		●	M282850
700 mm	4,60 kg	○	M282920
		●	M282910
		●	M282930
		●	M282950
		○	M282950

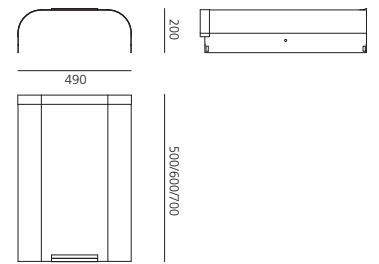

90° profile

Angle	Weight	Color	Code
left	4,80 kg	○	M283220
		●	M283210
		●	M283230
		●	M283250
right	4,80 kg	○	M283320
		●	M283310
		●	M283330
		●	M283350

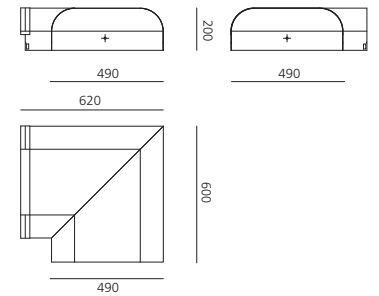
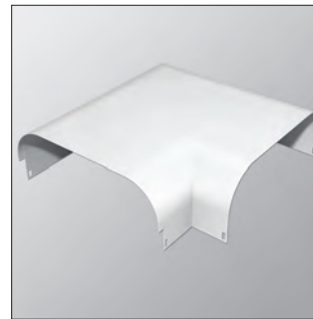

End cap

Weight	Color	Code
1,60 kg	○	M283120
	●	M283110
	●	M283130
	●	M283150

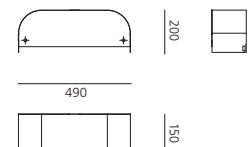

Caelum structural modules

White Black

Linear structural module (set of 2)

Length	Weight	Color	Code
500 mm	1,10 kg	<input type="radio"/>	M284120
		<input checked="" type="radio"/>	M284110
1000 mm	2,20 kg	<input type="radio"/>	M284220
		<input checked="" type="radio"/>	M284210
2000 mm	4,40 kg	<input type="radio"/>	M284320
		<input checked="" type="radio"/>	M284310
3000 mm	6,60 kg	<input type="radio"/>	M284420
		<input checked="" type="radio"/>	M284410

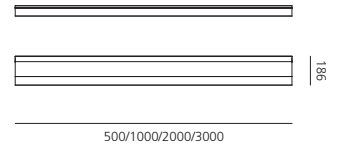

90° structural module

Angle	Weight	Color	Code
inner	0,30 kg	<input type="radio"/>	M284520
		<input checked="" type="radio"/>	M284510
outer	2,30 kg	<input type="radio"/>	M284720
		<input checked="" type="radio"/>	M284710

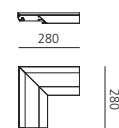
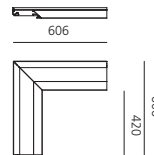

End caps structural module (set of 2)

Weight	Color	Code
3,30 kg	<input type="radio"/>	M284620
	<input checked="" type="radio"/>	M284610

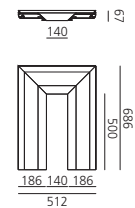

Connectors

Code
Kit power connectors (2pz)
M280900
Kit spacers connector (5pz)
M281000

Caelum 90 LED

White Black

W	Weight	Beam	Flux	CCT	Color	Code
28W	1,20 kg	20°	1700 lm	3000 K	<input type="radio"/>	M275625
				4000 K	<input type="radio"/>	M275615
			1768 lm	3000 K	<input type="radio"/>	M275725
		50°	1596 lm	3000 K	<input type="radio"/>	M275715
				4000 K	<input type="radio"/>	M276025
			1660 lm	3000 K	<input type="radio"/>	M276015
			4000 K	<input type="radio"/>	M276125	
				<input type="radio"/>	M276115	



IP20 850°

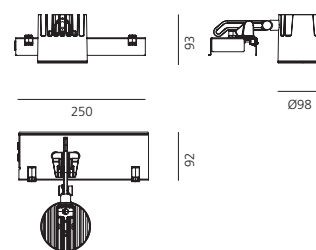

220/240Vac 50/60Hz electronic ballast included.

Caelum 90 LED 20°

LED	luminaire	
25 W	25W	28 W
2617 lm	2722 lm	1700 lm
3000 K	4000 K	3000 K
CRI =80 (typ.)		
Color tolerance MacAdam 3SDCM		
Service life L70(9K) > 54000h		
		20°
		20°
		65%
		65%
105 lm/W	109 lm/W	61 lm/W
		63 lm/W

28 W 3000 K α=20° 4000 K α=20°

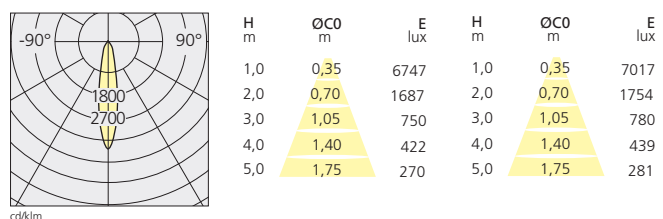







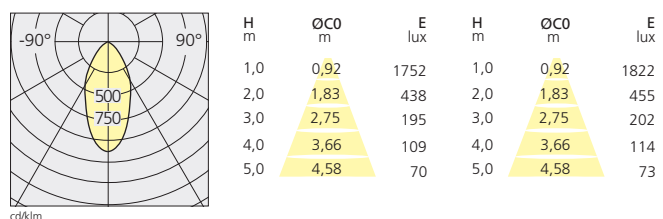

Caelum 90 LED 50°

LED	luminaire	
25 W	25W	28 W
2617 lm	2722 lm	1596 lm
3000 K	4000 K	3000 K
CRI =80 (typ.)		
Color tolerance MacAdam 3SDCM		
Service life L70(9K) > 54000h		
		50°
		50°
		61%
		61%
105 lm/W	109 lm/W	57 lm/W
		59 lm/W

28 W 3000 K α=50° 4000 K α=50°

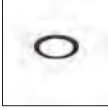

Accessoires

	Color	Code
		M282007
		M281745
		M281755
		M281735
		M282100
		M285207
		M285007
		M285107



Caelum 90 HIT

White Black

HIT-TC-CE (G8,5)

W	Weight	Beam	Flux	Color	Code
35 W	1,20 kg	10°	3000 lm	<input type="radio"/>	M277225
				<input checked="" type="radio"/>	M277215
		24°	3000 lm	<input type="radio"/>	M277425
				<input checked="" type="radio"/>	M277415
		38°	3000 lm	<input type="radio"/>	M277525
				<input checked="" type="radio"/>	M277515
70 W	1,20 kg	10°	6200 lm	<input type="radio"/>	M277625
				<input checked="" type="radio"/>	M277615
		24°	6200 lm	<input type="radio"/>	M277825
				<input checked="" type="radio"/>	M277815
		38°	6200 lm	<input type="radio"/>	M277925
				<input checked="" type="radio"/>	M277915



IP20

850°



220/240Vac 50/60Hz electronic ballast included.

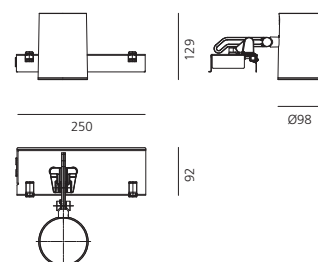

35 W/3000 lm

Efficiency 58% α=10°

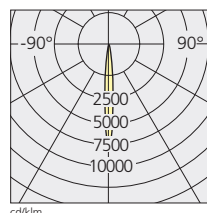

35 W/3000 lm

Efficiency 66% α=24°

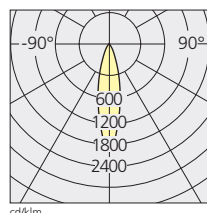

35 W/3000 lm

Efficiency 63% α=38°

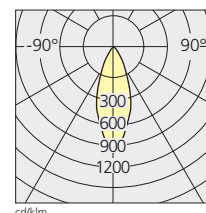

70 W/6200 lm

Efficiency 57% α=10°

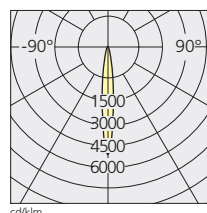

70 W/6200 lm

Efficiency 64% α=24°

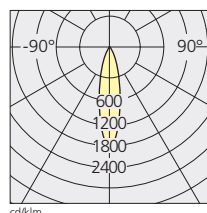





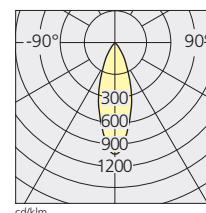

70 W/6200 lm

Efficiency 63% α=38°



Accessoires

	Color	Code
		M281807
		M282007
		M281907
	<ul style="list-style-type: none">●●●	<ul style="list-style-type: none">M281745M281755M281735
		M282100
		M285207



Caelum 120 LED

White Black

W	Weight	Beam	Flux	CCT	Color	Code
35 W	1,70 kg	16°	2297 lm	3000 K	<input type="radio"/>	M276225
			2448 lm	4000 K	<input type="radio"/>	M276325
					<input checked="" type="radio"/>	M276315
		36°	2232 lm	3000 K	<input type="radio"/>	M276425
					<input checked="" type="radio"/>	M276415
			3600 lm	4000 K	<input type="radio"/>	M276525
				<input checked="" type="radio"/>	M276515	



IP20 850°



220/240Vac 50/60Hz electronic ballast included.

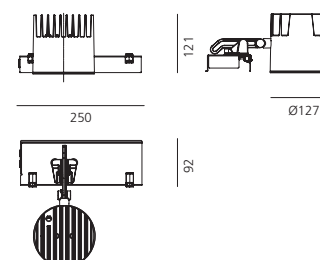

Caelum 120 LED 16°

	LED		luminaire	
Power	31 W	31 W	35 W	35 W
Flux	3384 lm	3600 lm	2072 lm	2248 lm
CCT	3000 K	4000 K	3000 K	4000 K
CRI	=80 (min.)			
Color tolerance	MacAdam 3SDCM			
Service life	L70(9K) >54000h			
Beam			16°	16°
Efficiency			68%	68%
Efficacy	109 lm/W 116lm/W		66 lm/W 70 lm/W	

35 W 3000 K α=16° 4000 K α=16°

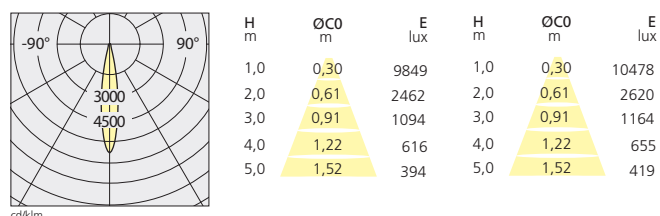







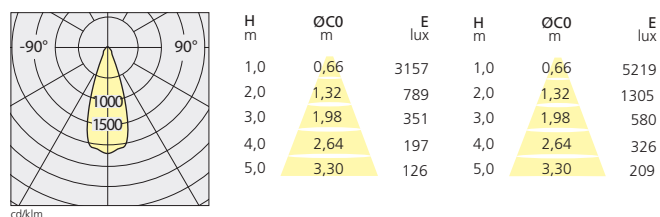

Caelum 120 LED 36°

	LED		luminaire	
Power	31 W	31 W	35 W	35 W
Flux	3384 lm	3600 lm	2232 lm	3600 lm
CCT	3000 K	4000 K	3000 K	4000 K
CRI	=80 (min.)			
Color tolerance	MacAdam 3SDCM			
Service life	L70(9K) >54000h			
Beam			36°	36°
Efficiency			66%	66%
Efficacy	109 lm/W 116lm/W		64 lm/W 68 lm/W	

35 W 3000 K α=36° 4000 K α=36°



Accessoires

	Color	Code
		M078700
		M078900
		M079000
		M282235
		M078400
		M078800
		M285307

Caelum 120 HIT

White Black

HIT-TC-CE (G12)

W	Weight	Beam	Flux	Color	Code
35 W	1,50 kg	24°	3500 lm	<input type="radio"/>	M280025
				<input checked="" type="radio"/>	M280015
		38°	3500 lm	<input type="radio"/>	M280125
70 W	1,50 kg			<input checked="" type="radio"/>	M280115
		50°	3500 lm	<input type="radio"/>	M280225
				<input checked="" type="radio"/>	M280215
70 W	1,50 kg	24°	6300 lm	<input type="radio"/>	M280325
				<input checked="" type="radio"/>	M280315
		38°	6300 lm	<input type="radio"/>	M280425
70 W	1,50 kg			<input checked="" type="radio"/>	M280415
		50°	6300 lm	<input type="radio"/>	M280525
				<input checked="" type="radio"/>	M280515



IP20 850°

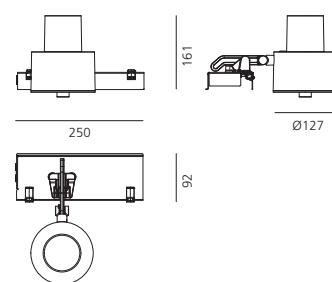

220/240Vac 50/60Hz electronic ballast included.

35 W/3500 lm Efficiency 62% α=24°

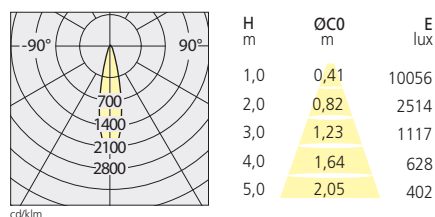

35 W/3500 lm Efficiency 58% α=38°

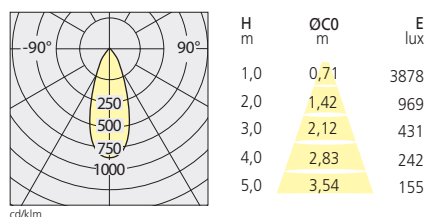

35 W/3500 lm Efficiency 59% α=50°

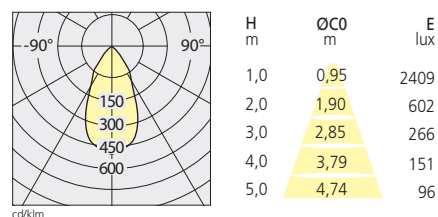

70 W/6300 lm Efficiency 63% α=24°

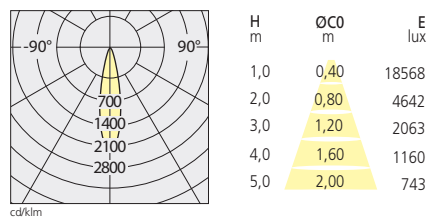



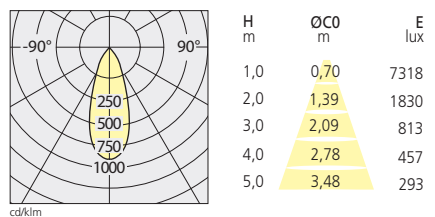

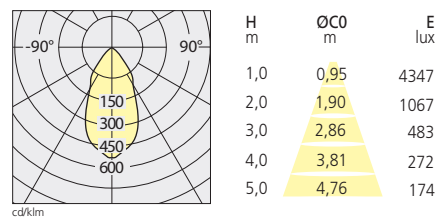

70 W/6300 lm Efficiency 61% α=38°



70 W/6300 lm Efficiency 63% α=50°



Accessoires

	Color	Code
		M282307
		M078700
		M282407
	<ul style="list-style-type: none">●●●	<ul style="list-style-type: none">M078900M079000M282235
		M078400
		M078800



Caelum 120 HIT - Caelum 120 HALO

White ○ Black ●

HIT (GX8,5)

W	Weight	Color	Code
35 W	1,30 kg	○	M280625
		●	M280615
70W	1,30 kg	○	M280725
		●	M280715

220/240Vac 50/60Hz electronic ballast included.



IP20 ⊕ 850°

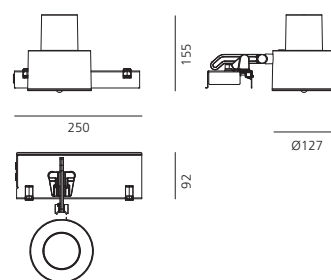

HALO (G53)

W	Weight	Color	Code
12 V	1,30 kg	○	M280825
max 100 W		●	M280815







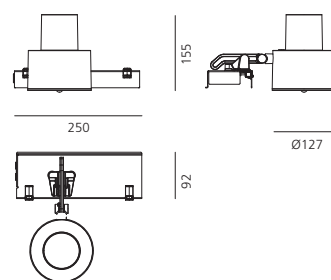
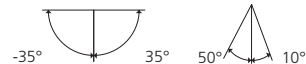

220/240Vac 50/60Hz electronic ballast included.



IP20 ⊕ 850°



Accessoires

	Color	Code
		M282307
		M282407
		M078900
		M079000
		M282235
		M078400
		M078700



Java

Ernesto Gismondi
2005



- Trim or trimless adjustable downlights using LED, QR111 12 V halogen and HIR111 metal halide lamps.
- 3 models: square with 1 lamp, rectangular with 2, 3 and 4 lamps.
- Each spotlight may be adjusted individually with a tilt angle ranging from -20° to $+70^{\circ}$, and rotation of up to 355° .

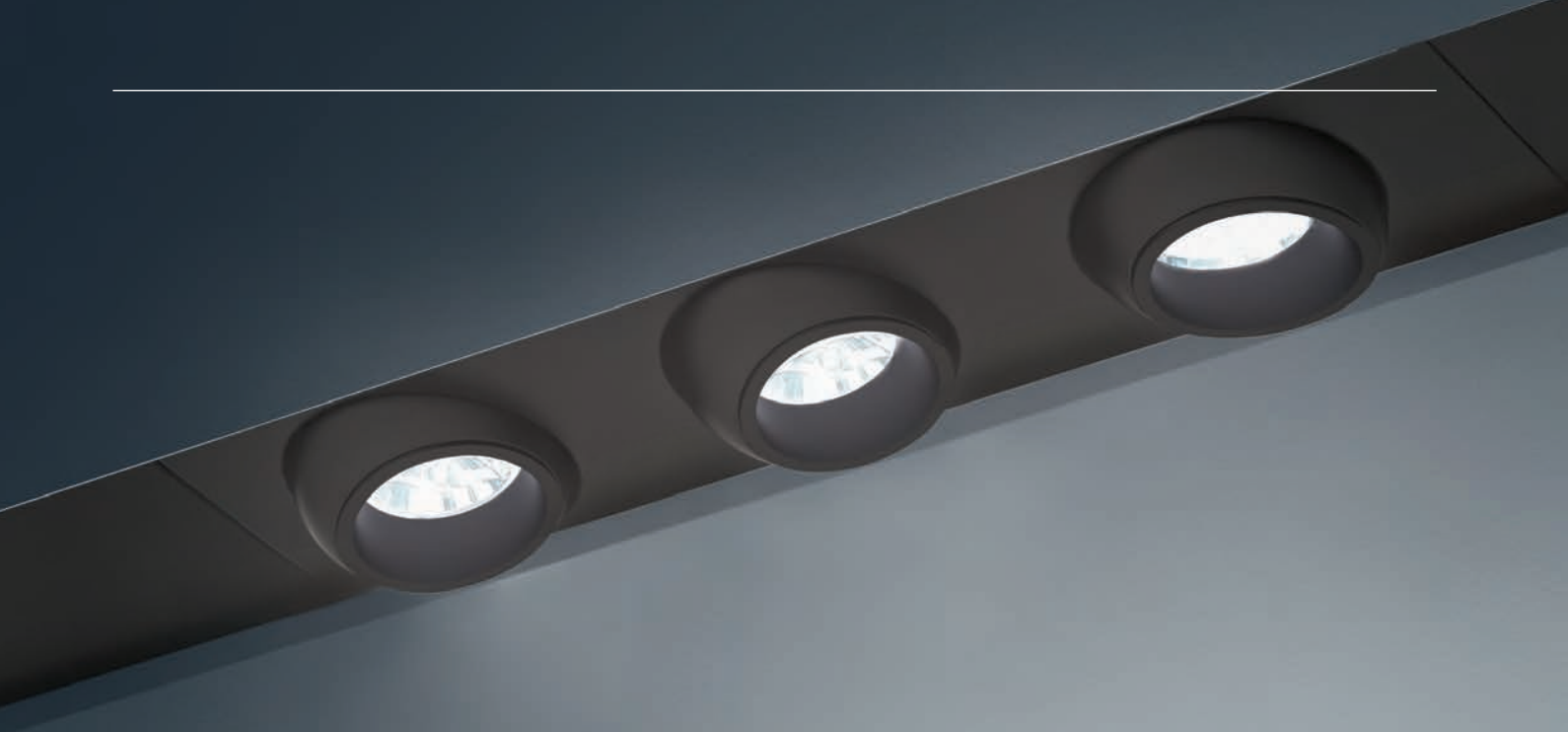

Java LED

White
○

W (LED)	Beam	Flux	CCT
26 W	12°	1983 lm	3000 K
	24°	1993 lm	3000 K
	36°	2034 lm	3000 K

Trim
Code
M2864W21
M2865W21
M2866W21

Trimless
Code
M2873W01
M2874W01
M2875W01



Electronic ballast 700 mA SELV supplied separately.

Driver	Vac	L _{mm}	W _{mm}	H _{mm}	n°device	
cc 50W 500mA	220-240	125	79	22	1 max	DALI/PUSH

Code
NL11035

IP20 ⊕

960°

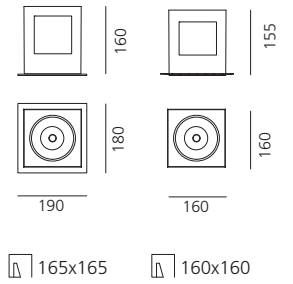

W (LED)	Beam	Flux	CCT
2x26 W	12°	3965 lm	3000 K
	24°	3987 lm	3000 K
	36°	4068 lm	3000 K

Trim
Code
M2867W21
M2868W21
M2869W21

Trimless
Code
M2876W01
M2877W01
M2878W01



Electronic ballast 700 mA SELV supplied separately.

Driver	Vac	L _{mm}	W _{mm}	H _{mm}	n°device	
cc 50W 500mA	220-240	125	79	22	1 max	DALI/PUSH

Code
NL11035

IP20 ⊕

960°

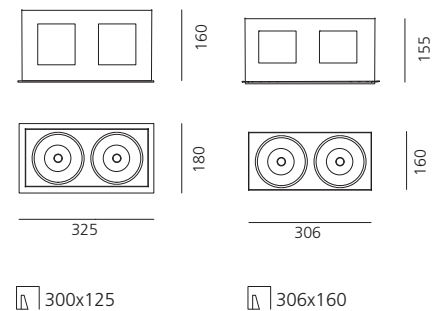

Java LED

White
○

				Trim	Trimless
W (LED)	Beam	Flux	CCT	Code	Code
3x26 W	12°	5948 lm	3000 K	M2870W21	M2879W01
	24°	5980 lm	3000 K	M2871W21	M2880W01
	36°	6102 lm	3000 K	M2872W21	M2881W01



Electronic ballast 700 mA SELV supplied separately.

Driver	Vac	L _{mm}	W _{mm}	H _{mm}	n°device	Code	IP20 ⊕	960°
cc 50W 500mA	220-240	125	79	22	1 max	DAU/PUSH	NL11035	

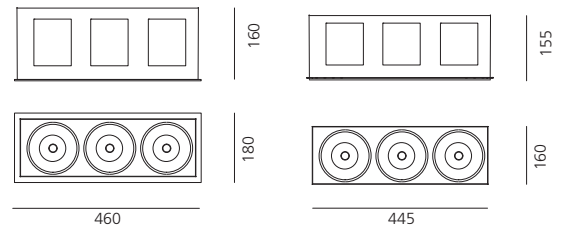

445x160

445x160

Java LED 12°	LED	luminaire	26 W	3000 K	α=12°		
Power	26 W	26 W		H _m	∅ _m	E _{Max} lux	E _M lux
Flux	2303 lm	1983 lm		1	0,22	20728	13284
CCT	3000 K	3000 K		2	0,43	5182	3321
CRI	=80 (min.)			3	0,65	2303	1476
Color tolerance	MacAdam 3SDCM			4	0,87	1295	830
Service life	L70(6K) > 50000h		5	1,09	829	531	
Beam		12°	cd/klm				
Efficiency		88%					
Efficacy	90 lm/W	66 lm/W					
Java LED 24°	LED	luminaire	26 W	3000 K	α=24°		
Power	26 W	26 W		H _m	∅ _m	E _{Max} lux	E _M lux
Flux	2303 lm	1993 lm		1	0,43	8177	5099
CCT	3000 K	3000 K		2	0,86	2044	1275
CRI	=80 (min.)			3	1,29	909	567
Color tolerance	MacAdam 3SDCM			4	1,73	511	319
Service life	L70(6K) > 50000h		5	2,16	327	204	
Beam		24°	cd/klm				
Efficiency		82%					
Efficacy	90 lm/W	67 lm/W					
Java LED 36°	LED	luminaire	26 W	3000 K	α=36°		
Power	26 W	26 W		H _m	∅ _m	E _{Max} lux	E _M lux
Flux	2303 lm	2034 lm		1	0,62	4990	2909
CCT	3000 K	3000 K		2	1,25	1248	727
CRI	=80 (min.)			3	1,87	554	323
Color tolerance	MacAdam 3SDCM			4	2,49	312	182
Service life	L70(6K) > 50000h		5	3,12	200	116	
Beam		36°	cd/klm				
Efficiency		88%					
Efficacy	90 lm/W	66 lm/W					

Java

Grey



QR111 (G53)

W	Weight	Color
12V 1xmax100 W	1,20 kg	●

Trim

Code
M049265

Trimless

Code
M069025

retrofit ► MASTER LED AR111 (GU53) 12V.
Driver 12Vdc SELV supplied separately



IP20 960°

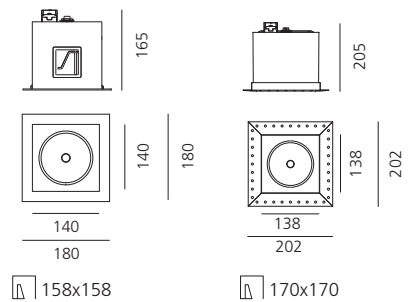
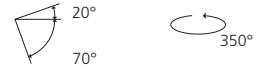

QR111 (G53)

W	Weight	Color
12V 2xmax100 W	1,90 kg	●

Trim

Code
M049365

Trimless

Code
M069125

retrofit ► MASTER LED AR111 (GU53) 12V.
Driver 12Vdc SELV supplied separately



IP20 960°

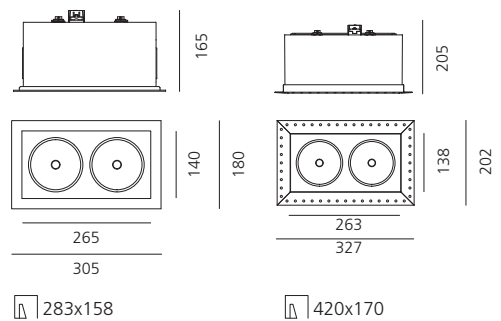

HIR111-CE-P (GX8,5)

W	Weight	Color
1xmax70 W	1,20 kg	●

Trim

Code
M049255

Trimless

Code
M069055

retrofit ► MASTER LED AR111 (GU53) 12V.
Driver 12Vdc SELV supplied separately

HIR111-CE-P (GX8,5)

W	Weight	Color
2xmax70 W	1,90 kg	●

Trim

Code
M049355

Trimless

Code
M069155

Driver 220/240Vac 50/60Hz supplied separately



QR111 (G53)

W 12V 3xmax100 W **Weight** 2,50 kg **Color** ●
 retrofit ► MASTER LED AR111 (GU53) 12V
 Driver 12Vdc SELV supplied separately

Trim

Code M049465

Trimless

Code M069225

HIR111-CE-P (GX8,5)

W 3xmax70 W **Weight** 2,50 kg **Color** ●
 Driver 220/240Vac 50/60Hz supplied separately

Trim

Code M049455

Trimless

Code M069255



QR111 + HIR111-CE-P

W 12V 2xmax100 W 1xmax70 W **Weight** 2,50 kg **Color** ●

Trim

Code M049865

Trimless

Code M069525

QR111 (G53) 12V 1xmax100 W 2,50 kg ●
 + **HIR111-CE-P (GX8,5)** 2xmax70 W

Code M049965

Code M069625

retrofit ► MASTER LED AR111 (GU53) 12V

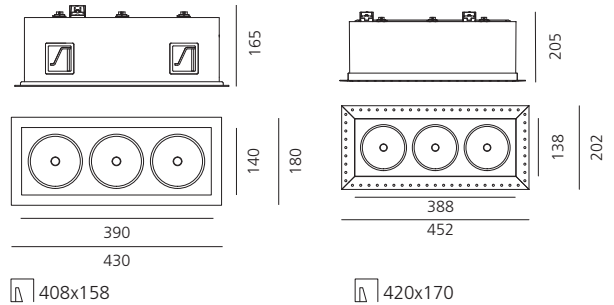
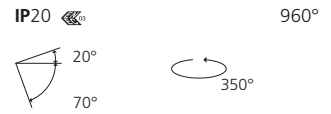

QR111 (G53)

W 12V 4xmax100 W **Weight** 3,20 kg **Color** ●
 retrofit ► MASTER LED AR111 (GU53) 12V

Trim

Code M049565

Trimless

Code M069325

HIR111-CE-P (GX8,5)

W 4xmax70 W **Weight** 3,20 kg **Color** ●

Trim

Code M049555

Trimless

Code M069355

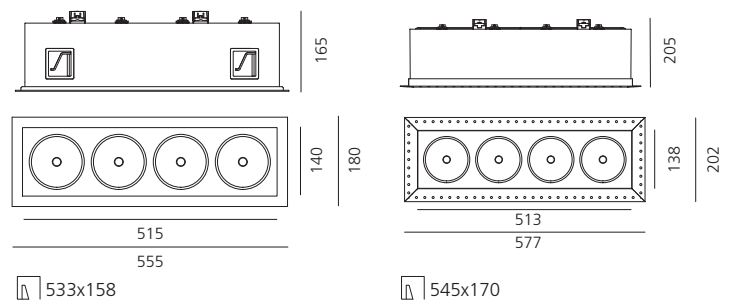

Control gears



Electronic transformer 230-240 V / 12 V.
Class II. Dimmable by trailing
or leading edge external dimmers.

10-60 W. 123x32x23 mm

35-105 W. 102x51x30 mm

35-150 W. 190x38x37 mm

Code

M070211

M070412

M072111



Electronic ballast 230-240 V
Class I

HIT 1x35 W. 155x83x32 mm

HIT 2x35 W. 180x80x34 mm

HIT 1x70 W. 180x80x34 mm

M070322

M070422

M070522



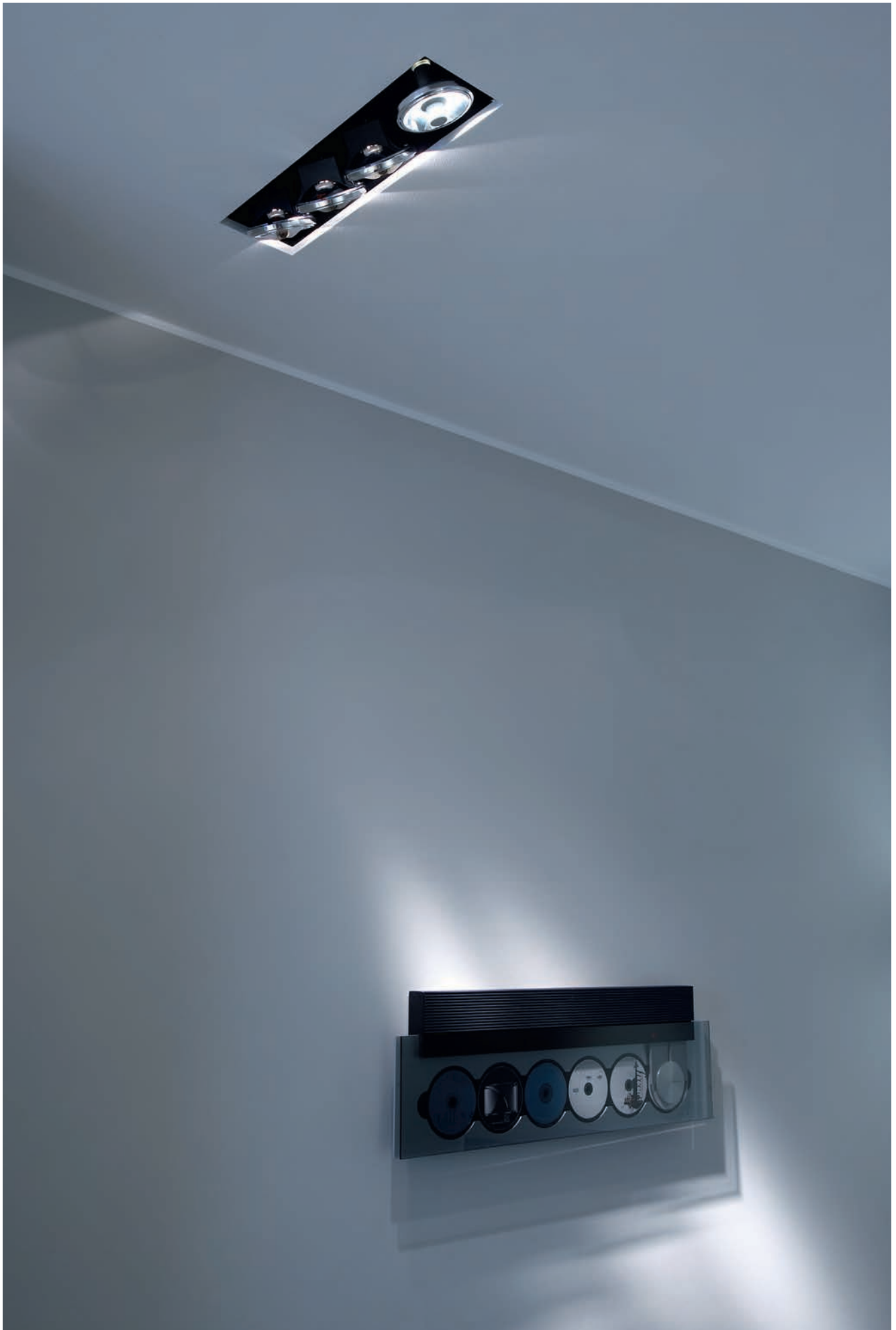

Java Linear System



Java linear system fluorescent

- Modular system for t16 fluorescent lamps, to be installed in a continuous line or as single luminaires.
- 3 lengths: 570mm (1x24 W T16), 1170 mm (1x54 W T16) and 2200 or 2340mm (2x54 W T16).
- Diffusing version is designed with movable lamp holders enabling the overlapping of lamps to guarantee uniform diffusion.
- Electronic ballast with or without dimming.
- End caps to be ordered separately.

Java linear system multispot

- Spotlighting system consisting of a recessed structure available in 2 size options, and lighting modules with 3 integral spotlights using 12 V halogen and metal halide lamps.
- Each spotlight may be adjusted by up to 30° in all directions.
- Combination with Java linear system diffuser versions possible by means of an intermediate connector to be ordered separately.
- Remote control gear.
- Complies with standard EN60598-1 and other specific standards.

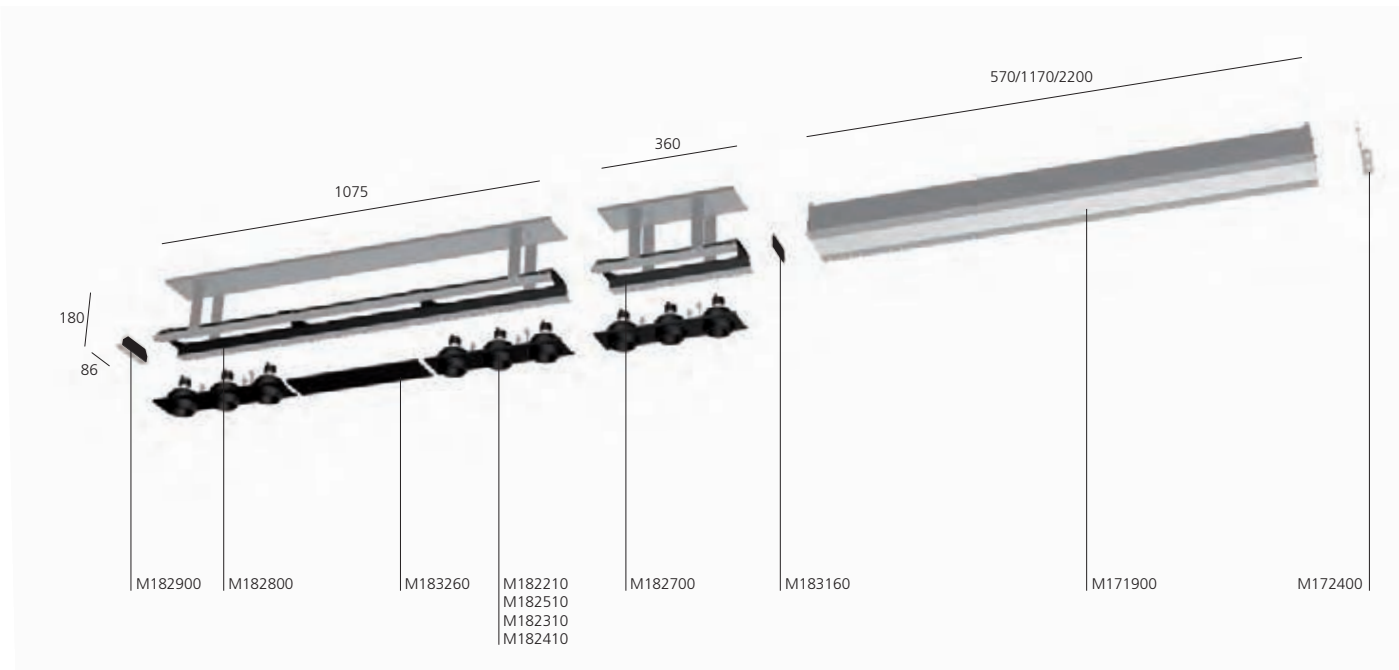
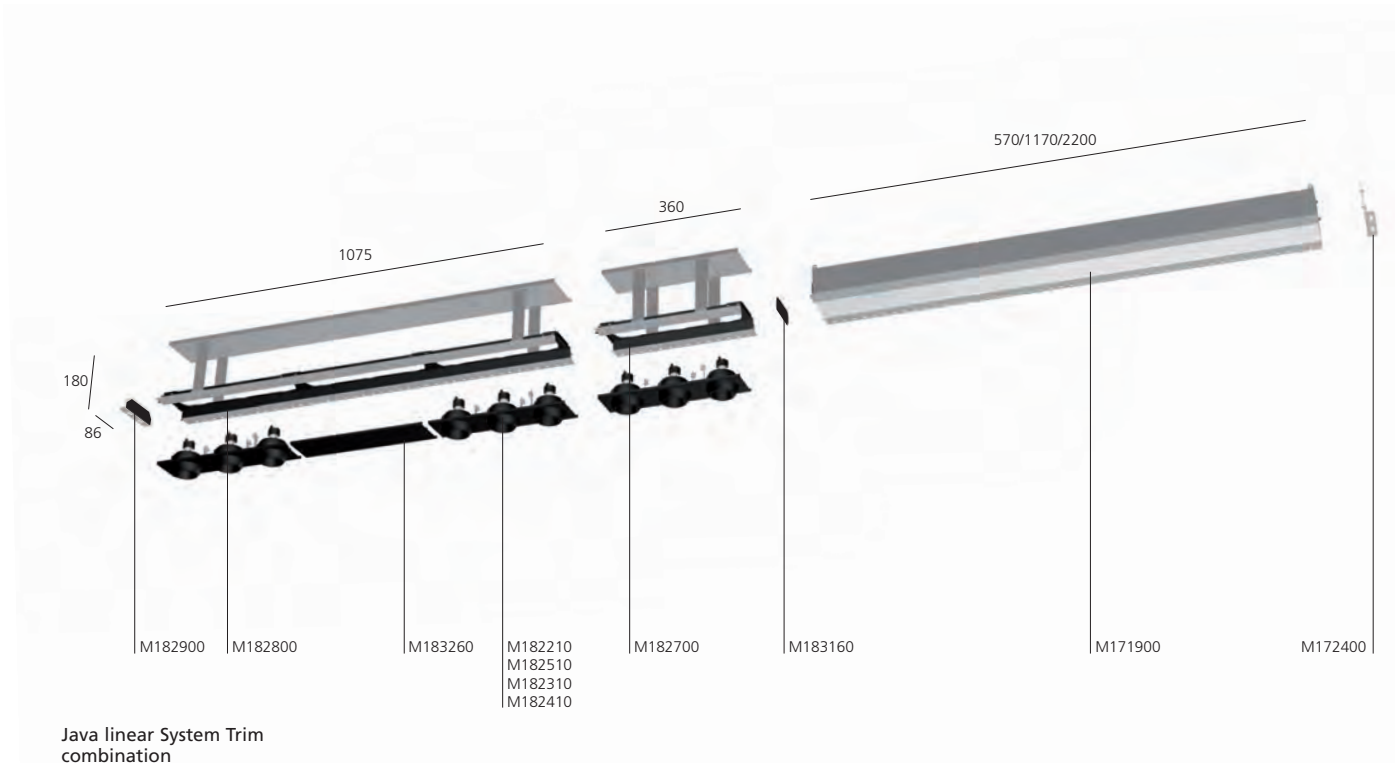

Java Linear System diffuser

Grey ●

TRIM

T16 (G5)

W	Weight	Length	Flux	Color
1x24 W	2,40 kg	570 mm	1750 lm	●
1x54 W	4,20 kg	1170 mm	4450 lm	●

Non dimmable

Code
M170300
M170400

Dimmable Dali

Code
M170301
M170401

+ emergency 1h

W	Weight	Length	Flux	Color
1x54 W	4,80 kg	1170 mm	4450 lm	●

Code
M170407

Non dimmable

Code
M170500

Dimmable Dali

Code
M170501
M170501

220/240Vac 50/60Hz electronic ballast included.



IP20 ☹️ 960°

120x(ΣL+10mm)

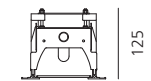
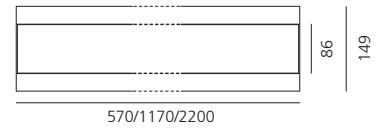

TRIMLESS

T16 (G5)

W	Weight	Length	Flux
1x24 W	2,40 kg	570 mm	1750 lm
1x54 W	4,20 kg	1170 mm	4450 lm

Non dimmable

Code
M171800
M171900

Dimmable Dali

Code
M171801
M171901

+ emergency 1h

W	Weight	Length	Flux
1x54 W	4,20 kg	1170 mm	4450 lm

Code
M171907

Non dimmable

Code
M172000

Dimmable Dali

Code
M172001
M172001

220/240Vac 50/60Hz electronic ballast included.



IP20 ☹️ 960°

120x(ΣL+10mm)

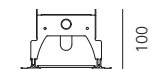
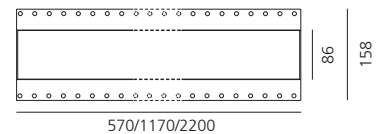

T16

Efficiency 26%

24 W	1750 lm
54 W	4450 lm
2x28 W	5200 lm
2x54 W	9800 lm

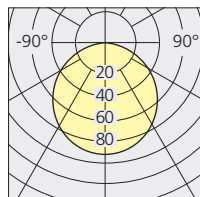

cd/klm

Accessories



End caps (set of 2).
For dark light and Diffuser versions.
31mm

Color ●

Trim

Code
M170900

Trimless

Code
M170900



Il televisore con il miglior audio al mondo.

"Il messaggio è eccezionale e la tecnologia audio incredibile"
(Home Cinema Doctor)

"I diffusori sono disposti sotto lo schermo con un audio di qualità davvero superiore"
(DI, Home)

"Non abbiamo paura di mettere al confronto che questo è il miglior audio tra quelli da un televisore"
(David Reynolds)

"Il design è davvero bello, non è solo una questione di stile, è una questione di funzionalità e di prestazioni. È un piacere guardare, anche da un CD"
(De La Haye)

"La grande eleganza e la ricchezza di effetti di questo televisore in un unico sistema, sono davvero un must"
(Blue Point & Co. It)

Java Linear System Multispot

Black ● Grey ●

TRIM

Structural module			
	Weight	Length	Color
For 1 lighting module	2,50 kg	360 mm	●
For 3 lighting modules	4,20 kg	1075 mm	●

Code
M182060
M182160



IP20
960°

120x(ΣL+10mm)

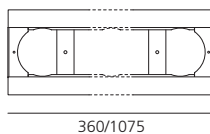

149

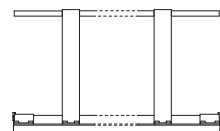

220

TRIMLESS

Structural module			
	Weight	Length	Code
For 1 lighting module	2,50 kg	360 mm	M182700
For 3 lighting modules	4,20 kg	1075 mm	M182800



120x(ΣL+10mm)

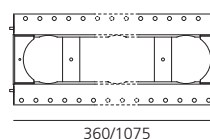

158

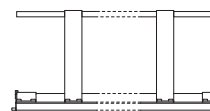

180

Java Linear System Multispot

Lighting module

QR-CBC51 (GU5,3)

W	Weight	Color	Code
12V 3xmax50 W	0,90 kg	●	M182210

Driver 12Vdc SELV supplied separately.

HIPAR51-CE-P (GX10)

W	Weight	Color	Code
3xmax35 W	0,90 kg	●	M182510

Driver 220/240Vac 50/60Hz supplied separately.

QRCBC51 + HIPAR51-CE-P

	W	Weight	Color	Code
QR-CBC51 (GU5,3)	12V 2xmax50 W	0,90 kg	●	M182310
+ HIPAR51-CE-P (GX10)	1xmax35 W			

QR-CBC51 (GU5,3)	12V 1xmax50 W	0,90 kg		M182410
+ HIPAR51-CE-P (GX10)	2xmax35 W			



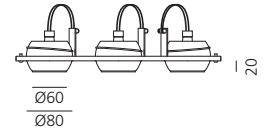
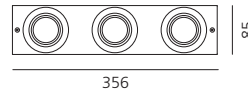
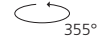

IP20
960°





Driver 12Vdc SELV supplied separately.
Driver supplied separately for HIT (GX 10).

Accessories

	Color	Code
 Cover (blind panel) 356mm	●	M183260
 End terminal (set of 2)	●	M183060
 Intermediate connector For combining Java linear System multispot and Java linear System dark light or diffuser.		M183160

Control gears

	Code
 Electronic transformer 230-240 V / 12 V Class II. Dimmable by trailing or leading edge external dimmers. 10-60W 123x32x23mm 35-105W 102x51x30mm 35-150W 190x38x37mm	M070211 M070412 M072111
 Electronic ballast 230-240 V Class I HIT 1x35W 155x83x32 mm HIT 2x35W 180x80x34 mm	M070322 M070422

37 Cube

Carlotta de Bevilacqua
Paola di Arianello
2011



37 Cube semi-recessed
scale 1:1

Minimal impact and pure functionality. Requiring a very limited amount of resources in terms of both material and energy consumption, 37 Cube is a miniature LED spotlight aimed at replacing MR16 dichroic light sources in terms of photometric performance, application and size. Featuring a perfect balance between size and luminous flux, 37 Cube combines extremely precise accent light with high energy-saving performance.

37 Cube



37 Cube semi-recessed
scale 1:1

- Minimal dimensions, material and energy consumption: 37mmx37mmx37mm.
- Effective and precise accent lighting with only 8W of total power consumption.
- 3 beam angles: 14°, 18°, 30°.
- 2 colour temperatures: warm white (3000K) and neutral white (4000K) – CRI=80 (typ.)
- Maximum flexibility: rotation 360°, tilt angle +90°/-90°.
- 2 installation options available: with control gear for mounting within Algoritmo product range or base plate for semi-recessed installation.
- Option of installation inside Algoritmo modules.
- Materials: body in anodised aluminium, translucent cover in polycarbonate.
- Complies with EN60598-1 standard and other specific standards.

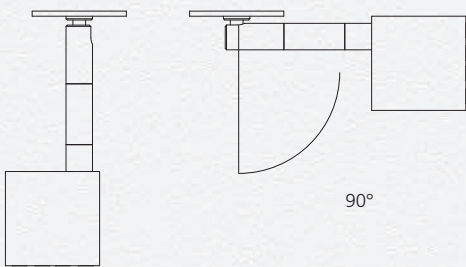

90°

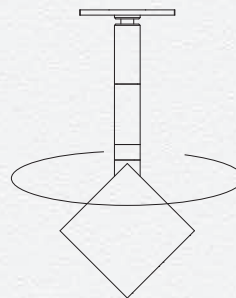
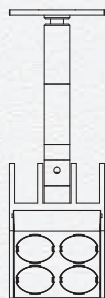

360°

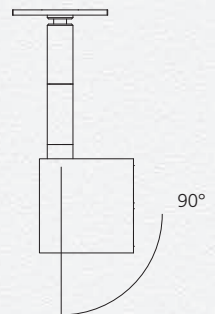

90°

37 Cube

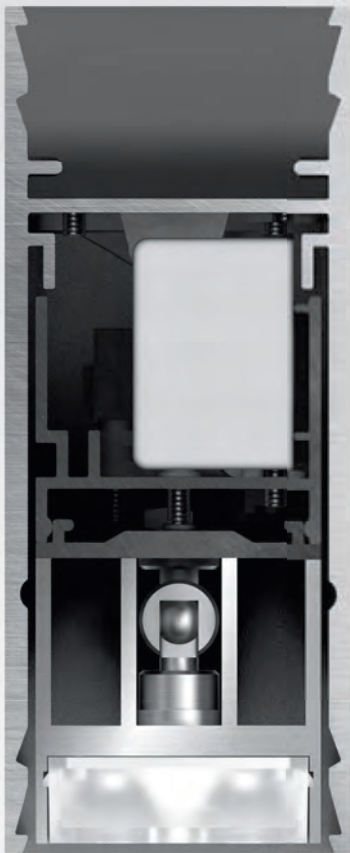
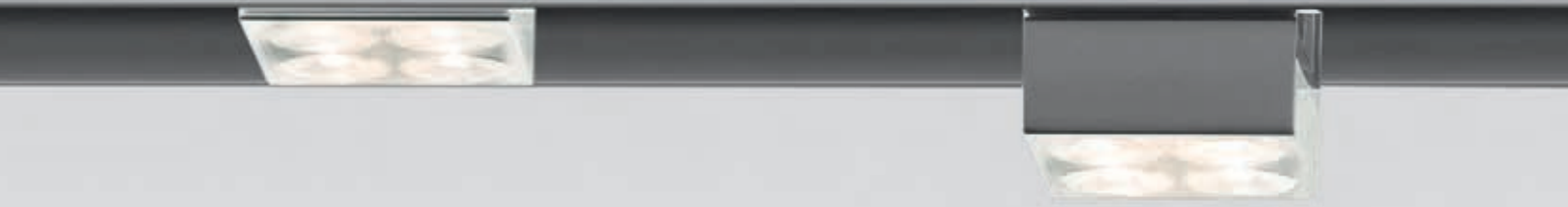

37 Cube for Algoritmo
vertical section
scale 1:1



37 Cube semi-recessed

Anodised aluminium



						Non dimmable
W	Weight	Beam	Flux	CCT	Color	Code
8 W	0,21 kg	14°	483 lm	3000 K	●	M028504
			517 lm	4000 K	●	M028604
	18°	463 lm	3000 K	●	M028704	
		495 lm	4000 K	●	M028804	
	30°	468 lm	3000 K	●	M028904	
		501 lm	4000 K	●	M029004	



IP20 650°



Ø30

220/240Vac 50/60Hz electronic ballast included.
Protection class: Class II. SELV. IP20.

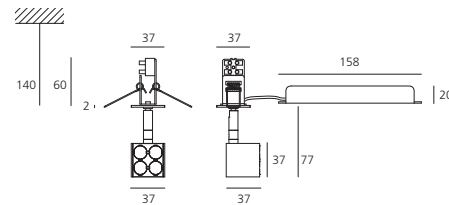

37 Cube 14°

LED	luminaire			
7 W	7 W	8 W	8 W	
528 lm	565 lm	483 lm	517 lm	
3000 K	4000 K	3000 K	4000 K	
CRI =80 (typ.)				
Color tolerance MacAdam 4SDCM				
Service life L70(6K) > 50000h				
		14°	14°	
		92%	92%	
75 lm/W	81 lm/W	60 lm/W	65 lm/W	

8 W	3000 K		α=14°		4000 K		α=14°	
	H m	Ø m	EMax lux	EM lux	H m	Ø m	EMax lux	EM lux
	1	0,25	4867	3240	1	0,25	5209	3468
	2	0,51	1217	810	2	0,51	1302	867
	3	0,76	541	360	3	0,76	579	385
	4	1,01	304	202	4	1,01	326	217
	5	1,26	195	130	5	1,26	208	139

37 Cube 18°

LED	luminaire			
7 W	7 W	8 W	8 W	
528 lm	565 lm	463 lm	495 lm	
3000 K	4000 K	3000 K	4000 K	
CRI =80 (typ.)				
Color tolerance MacAdam 4SDCM				
Service life L70(6K) > 50000h				
		18°	18°	
		88%	88%	
75 lm/W	81 lm/W	58 lm/W	62 lm/W	

8 W	3000 K		α=18°		4000 K		α=18°	
	H m	Ø m	EMax lux	EM lux	H m	Ø m	EMax lux	EM lux
	1	0,32	2484	1906	1	0,32	3190	2038
	2	0,64	746	476	2	0,64	798	509
	3	0,97	332	212	3	0,97	354	226
	4	1,29	187	119	4	1,29	199	127
	5	1,61	119	76	5	1,61	128	82

37 Cube 30°

LED	luminaire			
7 W	7 W	8 W	8 W	
528 lm	565 lm	468 lm	501 lm	
3000 K	4000 K	3000 K	4000 K	
CRI =80 (typ.)				
Color tolerance MacAdam 4SDCM				
Service life L70(6K) > 50000h				
		30°	30°	
		89%	89%	
75 lm/W	81 lm/W	59 lm/W	63 lm/W	

8 W	3000 K		α=30°		4000 K		α=30°	
	H m	Ø m	EMax lux	EM lux	H m	Ø m	EMax lux	EM lux
	1	0,54	1230	740	1	0,54	1316	793
	2	1,07	307	185	2	1,07	329	198
	3	1,61	137	82	3	1,61	146	88
	4	2,14	77	46	4	2,14	82	50
	5	2,68	49	30	5	2,68	53	32



Kit containing 3 projectors for Algoritmo System

Anodised aluminium
●

Non dimmable

W (LED)	Weight	Beam	Flux	CCT	Color	Code
3x8 W	0,47 kg	14°	3x483 lm	3000 K	●	M029100
			3x517 lm	4000 K	●	M029400
		18°	3x463 lm	3000 K	●	M029200
			3x495 lm	4000 K	●	M029500
		30°	3x468 lm	3000 K	●	M029300
			3x501 lm	4000 K	●	M029600



IP20
650°

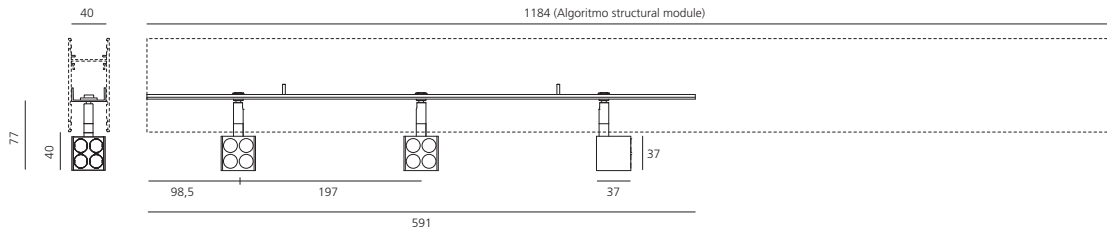
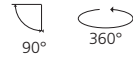

For Algoritmo, please see page 344

37 Cube 14°

LED	luminaire			
Power	7 W	7 W	8 W	8 W
Flux	528 lm	565 lm	483 lm	517 lm
CCT	3000 K	4000 K	3000 K	4000 K
CRI	=80 (typ.)			
Color tolerance	MacAdam 4SDCM			
Service life	L70(6K) > 50000h			
Beam			14°	14°
Efficiency			92%	92%
Efficacy	75 lm/W	81 lm/W	60 lm/W	65 lm/W

8 W	3000 K		α=14°		4000 K		α=14°	
H m	Ø m	EMax lux	EM lux	H m	Ø m	EMax lux	EM lux	
1	0,25	4867	3240	1	0,25	5209	3468	
2	0,51	1217	810	2	0,51	1302	867	
3	0,76	541	360	3	0,76	579	385	
4	1,01	304	202	4	1,01	326	217	
5	1,26	195	130	5	1,26	208	139	

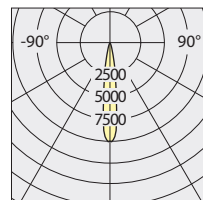

37 Cube 18°

LED	luminaire			
Power	7 W	7 W	8 W	8 W
Flux	528 lm	565 lm	463 lm	495 lm
CCT	3000 K	4000 K	3000 K	4000 K
CRI	=80 (typ.)			
Color tolerance	MacAdam 4SDCM			
Service life	L70(6K) > 50000h			
Beam			18°	18°
Efficiency			88%	88%
Efficacy	75 lm/W	81 lm/W	58 lm/W	62 lm/W

8 W	3000 K		α=18°		4000 K		α=18°	
H m	Ø m	EMax lux	EM lux	H m	Ø m	EMax lux	EM lux	
1	0,32	2484	1906	1	0,32	3190	2038	
2	0,64	746	476	2	0,64	798	509	
3	0,97	332	212	3	0,97	354	226	
4	1,29	187	119	4	1,29	199	127	
5	1,61	119	76	5	1,61	128	82	

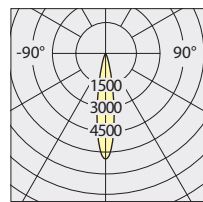

37 Cube 30°

LED	luminaire			
Power	7 W	7 W	8 W	8 W
Flux	528 lm	565 lm	468 lm	501 lm
CCT	3000 K	4000 K	3000 K	4000 K
CRI	=80 (typ.)			
Color tolerance	MacAdam 4SDCM			
Service life	L70(6K) > 50000h			
Beam			30°	30°
Efficiency			89%	89%
Efficacy	75 lm/W	81 lm/W	59 lm/W	63 lm/W

8 W	3000 K		α=30°		4000 K		α=30°	
H m	Ø m	EMax lux	EM lux	H m	Ø m	EMax lux	EM lux	
1	0,54	1230	740	1	0,54	1316	793	
2	1,07	307	185	2	1,07	329	198	
3	1,61	137	82	3	1,61	146	88	
4	2,14	77	46	4	2,14	82	50	
5	2,68	49	30	5	2,68	53	32	

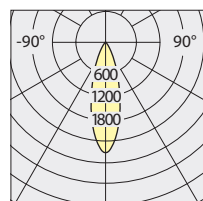



PAD/PAD Square

Le poème de l'angle droit

Carlotta de Bevilacqua

2010 (PAD)

2011 (PAD Square)





PAD (Poème de l'angle droit) is an advanced projector aiming to outperform traditional halogen sources. In this series of products, the light source and power supply are connected via integrated technological innovation. This patent-pending range of projectors are distinguished by excellent photometric performances, compact design and great adjustability.

PAD/PAD Square
Le poème de l'angle droit





- Compact dimensions:
PAD, 85mm x 170mm x 16mm – PAD Square, 168mm x 170mm x 16mm
- Ultra-flat power source (8mm height): high efficiency and extraordinary versatile power input from 100 to 240v, 50 and 60 Hz.
- Optimized thermal management: passive cooling system based on the extension of aluminium surface and partition of the LED sources (PAD 12 LED-12W PAD SQUARE 24 LED-24W).
- 3 beam angles: 12°, 24°, 36°.
- 2 colour temperatures: warm white (3000K) and neutral white (4000K) - CRI=80 (typ.).
- Innovative aluminium joint: compact dimensions and maximum flexibility: 358° rotation and 180° tilt angle
- 2 sizes and power: PAD (12LED-14,5W total load, 85mm x 170mm x 16mm) and PAD Square (24LED-29W total load, 168mm x 170mm x 16mm).
- 4 installation options: with adaptor for 3-circuit track, with gear plate for mounting within Algoritmo product range, wall/ceiling mounted version, or base plate for semi-recessed mounting.
- Wall/ceiling and semi-recessed versions available with SwitchDim.
- Materials: body in extruded aluminium, transparent cover in polycarbonate, translucent cover in polycarbonate, joint in die-cast aluminium.
- Complies with EN60598-1 standard and other specific standards.

PAD/PAD Square
Le poème de l'angle droit



Transparent cover – lens holder
Guarantees protection of electrical parts.
Injection-moulded polycarbonate.



Interchangeable lenses
Cover acts as support for available lenses
With 3 different angles:
12°
24°
36°



Translucent cover
Gives a diffused light effect. Together with transparent cover, helps protect electrical parts.
Injection-moulded polycarbonate.

Patent (EU) n° 11161969.8
Patent pending (IT) n° MI2010A000609
Patent pending (US) n° 13/083.318

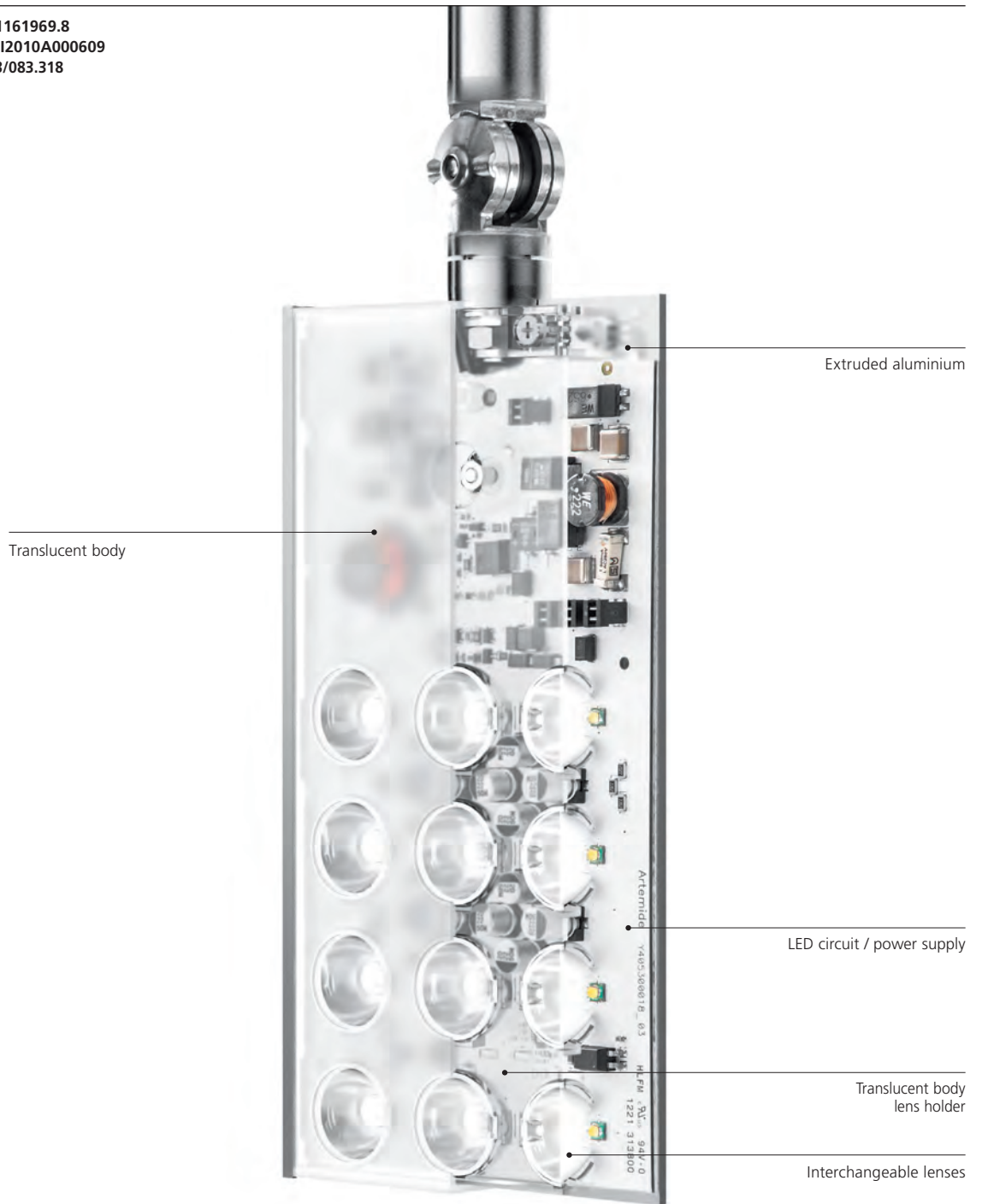

PAD/PAD Square
Le poème de l'angle droit

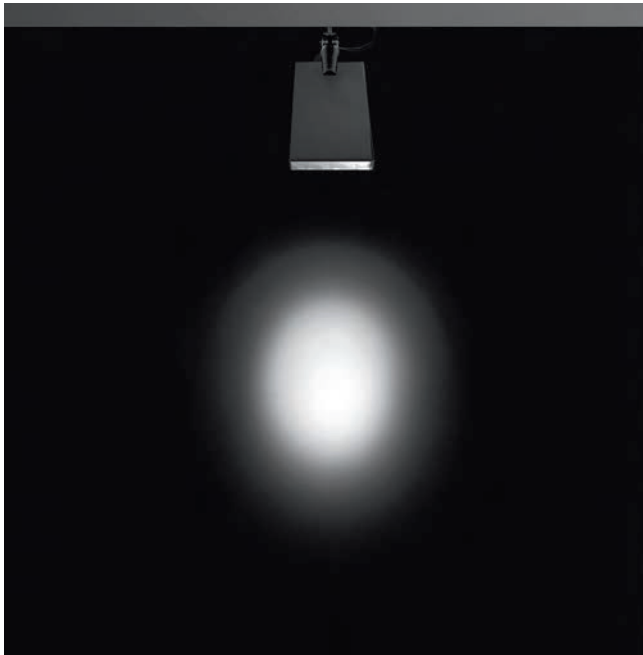

Spot
Beam angle = 12°
Ideal to highlight small items.



Medium flood
Beam angle = 24°
Standard feature for accent lighting of medium-sized object.



Flood
Beam angle = 36°
Accent lighting of large object.



TIR: Total Internal Reflection

PAD/PAD Square
Le poème de l'angle droit



Thermal management

The uniform fragmentation of LED sources provides optimized heat dissipation.

21,7°C

56,5°C

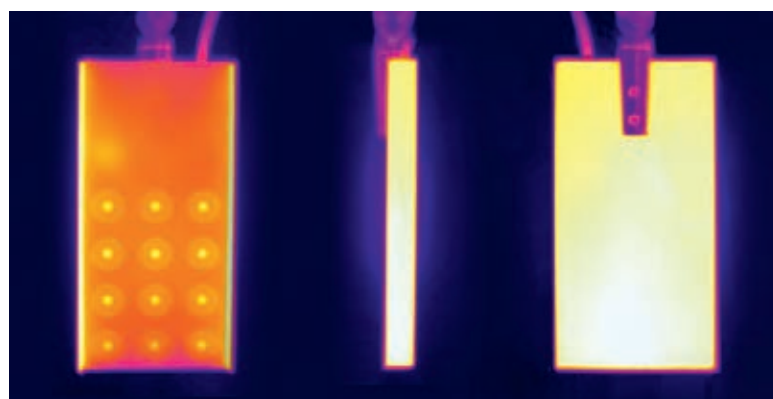



Joint

Excellent flexibility of light adjustment.

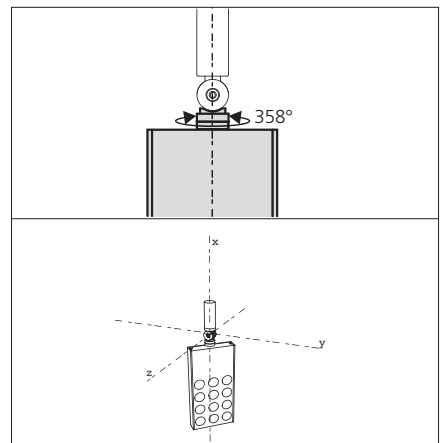
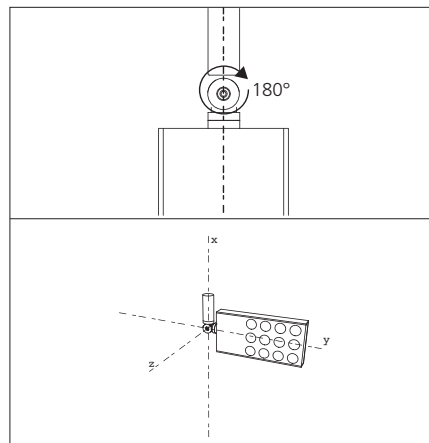
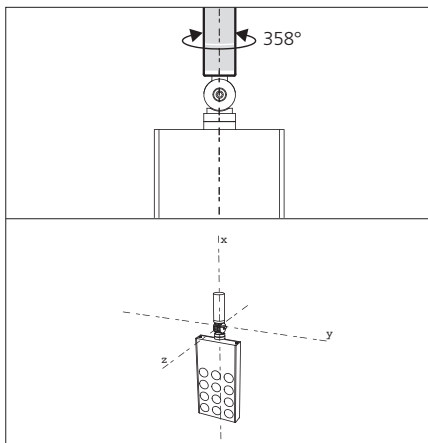

PAD/PAD Square

Le poème de l'angle droit



PAD track
12 LED 12W
12° - 24° - 36°
CRI = 80 (typ.)
220V - 240V _ 14,5W
non dimmable

PAD kit for Algoritmo System
12 LED 12W
12° - 24° - 36°
CRI = 80 (typ.)
220V - 240V _ 14,5W
non dimmable

PAD ceiling
12 LED 12W
12° - 24° - 36°
CRI = 80 (typ.)
220V - 240V _ 14,5W
SwitchDim dimmable

PAD semirecessed
12 LED 12W
12° - 24° - 36°
CRI = 80 (typ.)
220V - 240V _ 14,5W
SwitchDim dimmable





PAD Square track
 24 LED 24W
 12° - 24° - 36°
 CRI = 80 (typ.)
 220V - 240V _ 29W
 non dimmable

PAD Square kit for Algoritmo System
 24 LED 24W
 12° - 24° - 36°
 CRI = 80 (typ.)
 220V - 240V _ 29W
 non dimmable

PAD Square ceiling
 24 LED 24W
 12° - 24° - 36°
 CRI = 80 (typ.)
 220V - 240V _ 29W
 non dimmable

PAD Square semirecessed
 24 LED 24W
 12° - 24° - 36°
 CRI = 80 (typ.)
 220V - 240V _ 29W
 non dimmable





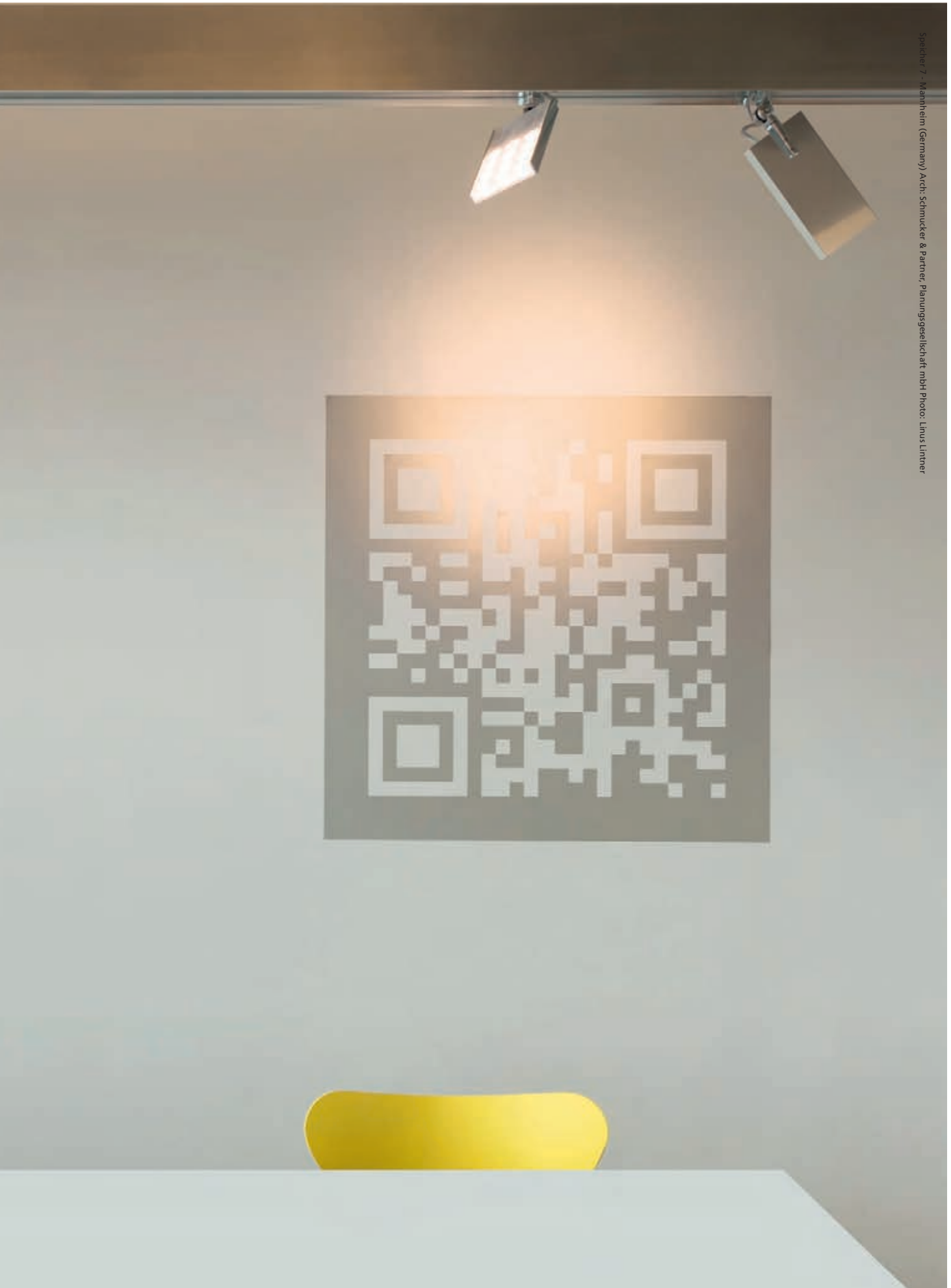

Speicher 7 - Mannheim (Germany) Arch: Schmucker & Partner Planungsgesellschaft mbH Photo: Linus Linner

PAD track

Gloss anodised



						Non dimmable	
W	Weight	Beam	Flux	CCT	Color	Code	
14,5 W	0,42 kg	12°	825 lm	3000 K		M200003	
			880 lm	4000 K		M200103	
		24°	825 lm	3000 K		M200203	
			880 lm	4000 K		M200303	
		36°	805 lm	3000 K		M200403	
			855 lm	4000 K		M200503	

220/240Vac 50/60Hz electronic ballast included.



IP40

650°

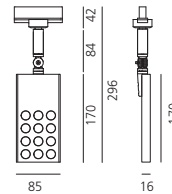

PAD kit for Algoritmo System

						Non dimmable	
W	Weight	Beam	Flux	CCT	Color	Code	
14,5 W	0,53 kg	12°	825 lm	3000 K		M200002	
			880 lm	4000 K		M200102	
		24°	825 lm	3000 K		M200202	
			880 lm	4000 K		M200302	
		36°	805 lm	3000 K		M200402	
			855 lm	4000 K		M200502	

220/240Vac 50/60Hz electronic ballast included.
For Algoritmo, please see page 340



IP40

650°

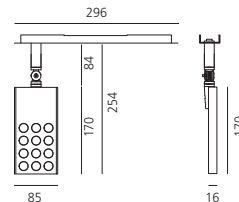

PAD ceiling

						SwitchDim	
W	Weight	Beam	Flux	CCT	Color	Code	
14,5 W	0,74 kg	12°	825 lm	3000 K		M200001	
			880 lm	4000 K		M200101	
		24°	825 lm	3000 K		M200201	
			880 lm	4000 K		M200301	
		36°	805 lm	3000 K		M200401	
			855 lm	4000 K		M200501	

220/240Vac 50/60Hz electronic ballast included.



IP40

650°

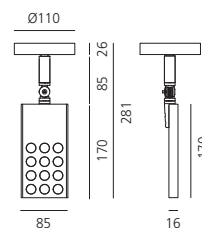

PAD semirecessed

Gloss anodised



W	Weight	Beam	Flux	CCT	Color	SwitchDim	Code
14,5 W	0,73 kg	12°	825 lm	3000 K			M200004
			880 lm	4000 K			M200104
		24°	825 lm	3000 K			M200204
			880 lm	4000 K			M200304
		36°	805 lm	3000 K			M200404
			855 lm	4000 K			M200504



IP40

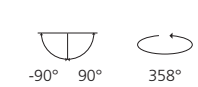

220/240Vac 50/60Hz electronic ballast included.

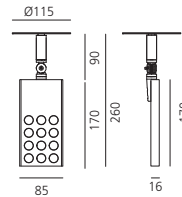

Pad 12°	LED	luminaire		3000 K	$\alpha=12^\circ$	4000 K	$\alpha=12^\circ$																																																									
Power	12 W	12 W	14,5 W	14,5 W	<table border="1"> <thead> <tr> <th>H</th> <th>Ø</th> <th>EMax</th> <th>EM</th> <th>H</th> <th>Ø</th> <th>EMax</th> <th>EM</th> </tr> <tr> <th>m</th> <th>m</th> <th>lux</th> <th>lux</th> <th>m</th> <th>m</th> <th>lux</th> <th>lux</th> </tr> </thead> <tbody> <tr><td>1</td><td>0,24</td><td>8073</td><td>5008</td><td>1</td><td>0,24</td><td>8611</td><td>5342</td></tr> <tr><td>2</td><td>0,47</td><td>2018</td><td>1252</td><td>2</td><td>0,47</td><td>2153</td><td>1335</td></tr> <tr><td>3</td><td>0,71</td><td>897</td><td>556</td><td>3</td><td>0,71</td><td>957</td><td>594</td></tr> <tr><td>4</td><td>0,94</td><td>505</td><td>313</td><td>4</td><td>0,94</td><td>538</td><td>334</td></tr> <tr><td>5</td><td>1,18</td><td>323</td><td>220</td><td>5</td><td>1,18</td><td>344</td><td>214</td></tr> </tbody> </table>				H	Ø	EMax	EM	H	Ø	EMax	EM	m	m	lux	lux	m	m	lux	lux	1	0,24	8073	5008	1	0,24	8611	5342	2	0,47	2018	1252	2	0,47	2153	1335	3	0,71	897	556	3	0,71	957	594	4	0,94	505	313	4	0,94	538	334	5	1,18	323	220	5	1,18	344	214
H	Ø	EMax	EM	H					Ø	EMax	EM																																																					
m	m	lux	lux	m					m	lux	lux																																																					
1	0,24	8073	5008	1					0,24	8611	5342																																																					
2	0,47	2018	1252	2					0,47	2153	1335																																																					
3	0,71	897	556	3					0,71	957	594																																																					
4	0,94	505	313	4					0,94	538	334																																																					
5	1,18	323	220	5					1,18	344	214																																																					
Flux	994 lm	1060 lm	825 lm	880 lm																																																												
CCT	3000 K	4000 K	3000 K	4000 K																																																												
CRI	=80 (typ.)																																																															
Color tolerance	MacAdam 4SDCM																																																															
Service life	L70(14K) > 81600h																																																															
Beam			12°	12°																																																												
Efficiency			83%	83%																																																												
Efficacy	82,8 lm/W	88,2 lm/W	56,8 lm/W	60,5 lm/W																																																												
Pad 24°	LED	luminaire		3000 K	$\alpha=24^\circ$	4000 K	$\alpha=24^\circ$																																																									
Power	12 W	12 W	14,5 W	14,5 W	<table border="1"> <thead> <tr> <th>H</th> <th>Ø</th> <th>EMax</th> <th>EM</th> <th>H</th> <th>Ø</th> <th>EMax</th> <th>EM</th> </tr> <tr> <th>m</th> <th>m</th> <th>lux</th> <th>lux</th> <th>m</th> <th>m</th> <th>lux</th> <th>lux</th> </tr> </thead> <tbody> <tr><td>1</td><td>0,41</td><td>3238</td><td>2009</td><td>1</td><td>0,41</td><td>3453</td><td>2143</td></tr> <tr><td>2</td><td>0,82</td><td>809</td><td>502</td><td>2</td><td>0,82</td><td>863</td><td>536</td></tr> <tr><td>3</td><td>1,23</td><td>360</td><td>223</td><td>3</td><td>1,23</td><td>384</td><td>238</td></tr> <tr><td>4</td><td>1,64</td><td>202</td><td>126</td><td>4</td><td>1,64</td><td>216</td><td>134</td></tr> <tr><td>5</td><td>2,05</td><td>130</td><td>80</td><td>5</td><td>2,05</td><td>138</td><td>86</td></tr> </tbody> </table>				H	Ø	EMax	EM	H	Ø	EMax	EM	m	m	lux	lux	m	m	lux	lux	1	0,41	3238	2009	1	0,41	3453	2143	2	0,82	809	502	2	0,82	863	536	3	1,23	360	223	3	1,23	384	238	4	1,64	202	126	4	1,64	216	134	5	2,05	130	80	5	2,05	138	86
H	Ø	EMax	EM	H					Ø	EMax	EM																																																					
m	m	lux	lux	m					m	lux	lux																																																					
1	0,41	3238	2009	1					0,41	3453	2143																																																					
2	0,82	809	502	2					0,82	863	536																																																					
3	1,23	360	223	3					1,23	384	238																																																					
4	1,64	202	126	4					1,64	216	134																																																					
5	2,05	130	80	5					2,05	138	86																																																					
Flux	994 lm	1060 lm	825 lm	880 lm																																																												
CCT	3000 K	4000 K	3000 K	4000 K																																																												
CRI	=80 (typ.)																																																															
Color tolerance	MacAdam 4SDCM																																																															
Service life	L70(14K) > 81600h																																																															
Beam			24°	24°																																																												
Efficiency			83%	83%																																																												
Efficacy	82,8 lm/W	88,2 lm/W	56,9 lm/W	60,6 lm/W																																																												
Pad 36°	LED	luminaire		3000 K	$\alpha=36^\circ$	4000 K	$\alpha=36^\circ$																																																									
Power	12 W	12 W	14,5 W	14,5 W	<table border="1"> <thead> <tr> <th>H</th> <th>Ø</th> <th>EMax</th> <th>EM</th> <th>H</th> <th>Ø</th> <th>EMax</th> <th>EM</th> </tr> <tr> <th>m</th> <th>m</th> <th>lux</th> <th>lux</th> <th>m</th> <th>m</th> <th>lux</th> <th>lux</th> </tr> </thead> <tbody> <tr><td>1</td><td>0,65</td><td>1493</td><td>893</td><td>1</td><td>0,65</td><td>1586</td><td>948</td></tr> <tr><td>2</td><td>1,30</td><td>373</td><td>223</td><td>2</td><td>1,30</td><td>397</td><td>237</td></tr> <tr><td>3</td><td>1,95</td><td>166</td><td>99</td><td>3</td><td>1,95</td><td>176</td><td>105</td></tr> <tr><td>4</td><td>2,61</td><td>93</td><td>56</td><td>4</td><td>2,61</td><td>99</td><td>59</td></tr> <tr><td>5</td><td>3,26</td><td>60</td><td>36</td><td>5</td><td>3,26</td><td>63</td><td>38</td></tr> </tbody> </table>				H	Ø	EMax	EM	H	Ø	EMax	EM	m	m	lux	lux	m	m	lux	lux	1	0,65	1493	893	1	0,65	1586	948	2	1,30	373	223	2	1,30	397	237	3	1,95	166	99	3	1,95	176	105	4	2,61	93	56	4	2,61	99	59	5	3,26	60	36	5	3,26	63	38
H	Ø	EMax	EM	H					Ø	EMax	EM																																																					
m	m	lux	lux	m					m	lux	lux																																																					
1	0,65	1493	893	1					0,65	1586	948																																																					
2	1,30	373	223	2					1,30	397	237																																																					
3	1,95	166	99	3					1,95	176	105																																																					
4	2,61	93	56	4					2,61	99	59																																																					
5	3,26	60	36	5					3,26	63	38																																																					
Flux	994 lm	1060 lm	805 lm	855 lm																																																												
CCT	3000 K	4000 K	3000 K	4000 K																																																												
CRI	=80 (typ.)																																																															
Color tolerance	MacAdam 4SDCM																																																															
Service life	L70(14K) > 81600h																																																															
Beam			36°	36°																																																												
Efficiency			81%	81%																																																												
Efficacy	82,8 lm/W	88,2 lm/W	55,5 lm/W	59,1 lm/W																																																												

PAD Square track

Gloss anodised
●

						Non dimmable
W	Weight	Beam	Flux	CCT	Color	Code
29 W	0,65 kg	12°	1650 lm	3000 K	●	M201503
			1750 lm	4000 K	●	M201603
		24°	1650 lm	3000 K	●	M201703
			1750 lm	4000 K	●	M201803
		36°	1610 lm	3000 K	●	M201903
			1710 lm	4000 K	●	M202003

220/240Vac 50/60Hz electronic ballast included.



IP40 ⊕
650°

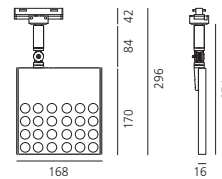

PAD Square kit for Algoritmo System

						Non dimmable
W	Weight	Beam	Flux	CCT	Color	Code
29W	0,76 kg	12°	1650 lm	3000 K	●	M201502
			1750 lm	4000 K	●	M201602
		24°	1650 lm	3000 K	●	M201702
			1750 lm	4000 K	●	M201802
		36°	1610 lm	3000 K	●	M201902
			1710 lm	4000 K	●	M202002

220/240Vac 50/60Hz electronic ballast included.
For Algoritmo, please see page 342



IP40 ⊕
650°

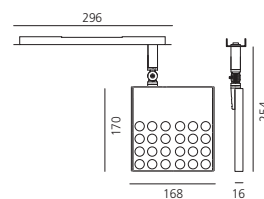

PAD Square ceiling

						Non dimmable
W	Weight	Beam	Flux	CCT	Color	Code
29 W	0,98 kg	12°	1650 lm	3000 K	●	M201501
			1750 lm	4000 K	●	M201601
		24°	1650 lm	3000 K	●	M201701
			1750 lm	4000 K	●	M201801
		36°	1610 lm	3000 K	●	M201901
			1710 lm	4000 K	●	M202001



IP40 ⊕
650°

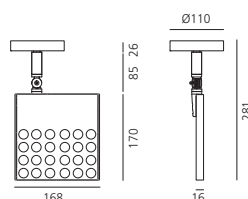
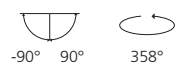

PAD Square semi-recessed

Gloss anodised

Non dimmable

W	Weight	Beam	Flux	CCT	Color	Code
29 W	0,97 kg	12°	1650 lm	3000 K		M201504
			1750 lm	4000 K		M201604
		24°	1650 lm	3000 K		M201704
			1750 lm	4000 K		M201804
		36°	1610 lm	3000 K		M201904
			1710 lm	4000 K		M202004



IP40 
 650°



220/240Vac 50/60Hz electronic ballast included.

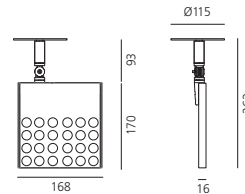

Pad Square 12°

LED	luminaire	
24 W	24 W	29 W
1988 lm	2120 lm	1650 lm
3000 K	4000 K	3000 K
CRI =80 (typ.)		4000 K
Color tolerance MacAdam 4SDCM		
Service life L70(14K) > 81600h		
Beam	12°	12°
Efficiency	83%	83%
Efficacy	82,8 lm/W	88,2 lm/W

29 W	3000 K	α=12°	4000 K	α=12°
	H m	Ø m	E _{Max} lux	EM lux
	1	0,24	16147	10016
	2	0,47	4037	2504
	3	0,71	1794	1113
	4	0,94	1009	626
5	1,18	646	401	

Pad Square 24°

LED	luminaire	
24 W	24 W	29 W
1988 lm	2120 lm	1650 lm
3000 K	4000 K	3000 K
CCT 4000 K		4000 K
CRI =80 (typ.)		
Color tolerance MacAdam 4SDCM		
Service life L70(14K) > 81600h		
Beam	24°	24°
Efficiency	83%	83%
Efficacy	82,8 lm/W	88,2 lm/W

29 W	3000 K	α=24°	4000 K	α=24°
	H m	Ø m	E _{Max} lux	EM lux
	1	0,41	6475	4018
	2	0,82	1619	1005
	3	1,23	719	446
	4	1,64	405	251
5	2,05	259	161	

Pad Square 36°

LED	luminaire	
24 W	24 W	29 W
1988 lm	2120 lm	1610 lm
3000 K	4000 K	3000 K
CCT 4000 K		4000 K
CRI =80 (typ.)		
Color tolerance MacAdam 4SDCM		
Service life L70(14K) > 81600h		
Beam	36°	36°
Efficiency	81%	81%
Efficacy	82,8 lm/W	88,2 lm/W

29 W	3000 K	α=36°	4000 K	α=36°
	H m	Ø m	E _{Max} lux	EM lux
	1	0,65	2987	1785
	2	1,30	747	446
	3	1,95	332	198
	4	2,61	187	112
5	3,26	119	71	

PAD 80

Carlotta de Bevilacqua
2012



PAD 80 recessed adjustable - fixed
scale 1:1



Featuring an elegant design with integrated components, the PAD (Poème de l'Angle Droit) range is now available in a new series of unique and flexible, ceiling-mounted LED products. This new range integrates modularity, extreme quality and high photometric performance; it is extremely flexible and perfect for many applications, specifically retail spaces and art galleries.







Light ON



Light OFF





- Efficient, clear accent lighting, fixed and adjustable.
- 3 beam angles: 15°, 24°, 36°.
- Diffused ambient lighting (in fixed version).
- 2 colour temperatures: warm white (3000K) and neutral white (4000K) - CRI=80 (min.).
- Excellent lighting efficiency > 70lm/W.
- High adjustability: 360° rotation, +90°/-90° tilt angle.
- Fixed version available as IP44.
- Easy installation of light modules, no tools required.
- Lighting units available in 3 finishes: gloss aluminium, painted white, painted black.
- Structural elements of recessed-mounted version available in 3 sizes, for use with 1, 2, 3 and 2x2 modules. 3 compatible finishes (polished aluminium, white, and black).
- Housing of ceiling-mounted version available in 3 sizes (1, 2, 3 lighting units), and 3 compatible finishes (polished aluminium, white and black).
- Recessed-mounted version available as trimless or framed.
- Materials: body in anodised extruded aluminium, diffuser in opal polycarbonate.
- Complies with standard EN60598-1 and other specific standards.





PAD 80 Recessed

White
○

Black
●

Gloss anodised
●

Frame for recessed installation

		Color
for 1 optic unit	103x103	○ ● ●
for 2 optic units	103x186	○ ● ●
for 3 optic units	103x271	○ ● ●
for 4 optic units	189x189	○ ● ●

Trim

Code
M246820
M246810
M246860
M246920
M246910
M246960
M247020
M247010
M247060
M247120
M247110
M247160

Trimless

Code
M246420
M246410
M246460
M246520
M246510
M246560
M246620
M246610
M246660
M246720
M246710
M246760

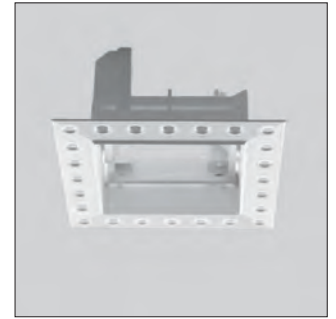

Independent power supply and optic units, to be ordered separately.
Plasterboard thickness from 1mm to 40mm

Trim

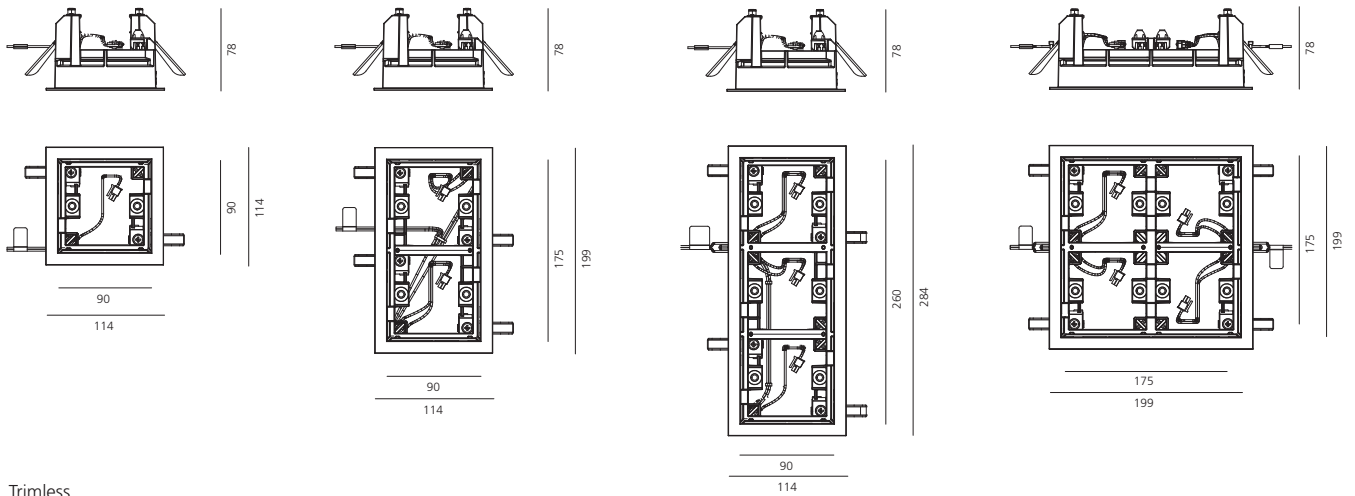

Trimless

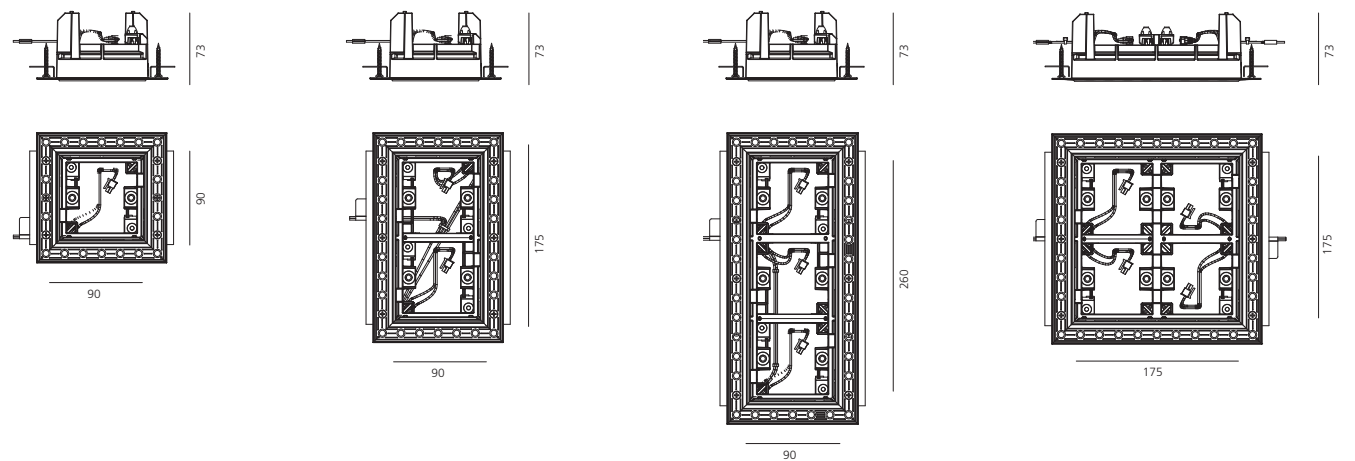



PAD 80 Ceiling

White
○

Black
●

Gloss anodised
◐

Frame for ceiling version

			Color	Code
for 1 optic unit	11 W	96x96x109 h	○	M247220
			●	M247210
			◐	M247260
for 2 optic units	21 W	96x181x109 h	○	M247320
			●	M247240
			◐	M247360
for 3 optic units	32 W	96x266x109 h	○	M247420
			●	M247410
			◐	M247460



Optic units, to be ordered separately.

220/240Vac 50/60Hz electronic ballast included

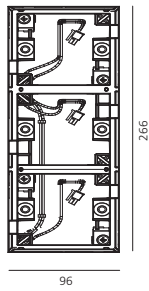
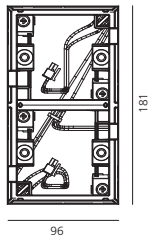
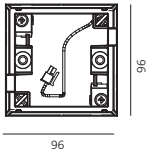
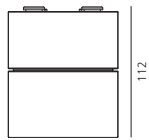
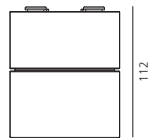
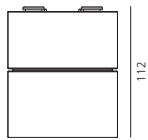



PAD 80 LED with fixed lenses

White ○ Black ● Gloss anodised ◐

LED optic unit

W (LED)	Weight	Beam	Flux	CCT	Light unit	Code	
9,5 W	0,35 kg	15°	710 lm	3000 K	○	M245020	
					●	M245010	
			◐	M245060			
			○	M245420			
		810 lm	4000 K	●	M245410		
				◐	M245460		
			24°	610 lm	3000 K	○	M245120
						●	M245110
		695 lm	4000 K	◐	M245160		
				○	M245520		
		36°	645 lm	3000 K	●	M245510	
					◐	M245560	
735 lm	4000 K		○	M245220			
			●	M245210			
◐	M245260						
○	M245620						
●	M245610						
◐	M245660						



▼ IP20 / ▲ IP44 ◐
650°

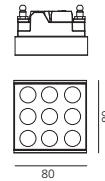

PAD 80 LED with adjustable lenses

LED optic unit

W (LED)	Weight	Beam	Flux	CCT	Light unit	Code
9,5 W	0,36 kg	15°	710 lm	3000 K	○	M245820
					●	M245810
			◐	M245860		
			810 lm	4000 K	○	M246120
					●	M246110
			◐	M246160		
		24°	610 lm	3000 K	○	M245920
					●	M245910
			695 lm	4000 K	◐	M245960
					○	M246220
		36°	645 lm	3000 K	●	M246210
					◐	M246260
			735 lm	4000 K	○	M246020
					●	M246010
		◐	M246060			
		○	M246320			
		●	M246310			
		◐	M246360			



IP20 ◐
650°

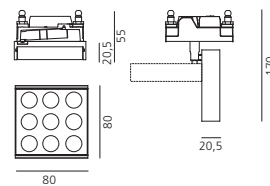

PAD 80 fixed diffuser

LED optic unit

W (LED)	Weight	Beam	Flux	CCT	Light unit	Code		
9,5 W	0,35 kg	98°	620 lm	3000 K	○	M245320		
					●	M245310		
					◐	M245360		
					704 lm	4000 K	○	M245720
							●	M245710
					◐	M245760		



▼ IP20 / ▲ IP44 ◐
650°

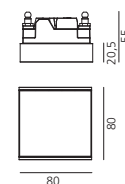

Pad 80	15°	LED	luminaire	
Power	9,5 W	9,5 W	9,5 W	9,5 W
Flux	830 lm	945 lm	710 lm	810 lm
CCT	3000 K	4000 K	3000 K	4000 K
CRI	≥80 (min.)			
Color tolerance	MacAdam 4SDCM			
Service life	L70(4K) > 60500h			
Beam			15°	15°
Efficiency			86%	86%
Efficacy	85,6 lm/W	95,7 lm/W	73,2 lm/W	83,5 lm/W

9,5 W	3000 K		α=15°		4000 K		α=15°	
	H _m	Ø _m	E _{Max} _{lux}	E _M _{lux}	H _m	Ø _m	E _{Max} _{lux}	E _M _{lux}
1	0,27	5165	3254	1	0,27	5892	3713	
2	0,53	1291	814	2	0,53	1473	938	
3	0,80	574	362	3	0,80	655	413	
4	1,07	323	203	4	1,07	368	232	
5	1,34	207	130	5	1,34	236	149	

Pad 80	24°	LED	luminaire	
Power	9,5 W	9,5 W	9,5 W	9,5 W
Flux	830 lm	945 lm	610 lm	695 lm
CCT	3000 K	4000 K	3000 K	4000 K
CRI	≥80 (min.)			
Color tolerance	MacAdam 4SDCM			
Service life	L70(4K) > 60500h			
Beam			24°	24°
Efficiency			73%	73%
Efficacy	85,6 lm/W	95,7 lm/W	62,8 lm/W	71,6 lm/W

9,5 W	3000 K		α=24°		4000 K		α=24°	
	H _m	Ø _m	E _{Max} _{lux}	E _M _{lux}	H _m	Ø _m	E _{Max} _{lux}	E _M _{lux}
1	0,42	1856	1148	1	0,42	2115	1308	
2	0,84	464	287	2	0,84	529	327	
3	1,26	206	128	3	1,26	235	145	
4	1,69	116	72	4	1,69	132	82	
5	2,11	74	46	5	2,11	85	52	

Pad 80	36°	LED	luminaire	
Power	9,5 W	9,5 W	9,5 W	9,5 W
Flux	830 lm	945 lm	645 lm	735 lm
CCT	3000 K	4000 K	3000 K	4000 K
CRI	≥80 (min.)			
Color tolerance	MacAdam 4SDCM			
Service life	L70(4K) > 60500h			
Beam			36°	36°
Efficiency			77%	77%
Efficacy	85,6 lm/W	95,7 lm/W	66,4 lm/W	75,7 lm/W

9,5 W	3000 K		α=36°		4000 K		α=36°	
	H _m	Ø _m	E _{Max} _{lux}	E _M _{lux}	H _m	Ø _m	E _{Max} _{lux}	E _M _{lux}
1	0,66	1218	737	1	0,66	1388	839	
2	1,33	304	184	2	1,33	347	210	
3	1,99	135	82	3	1,99	154	93	
4	2,66	76	46	4	2,66	87	52	
5	3,32	49	29	5	3,32	56	34	

PAD 80 fixed diffuser	LED	luminaire		
Power	9,5 W	9,5 W	9,5 W	9,5 W
Flux	830 lm	945 lm	620 lm	704 lm
CCT	3000 K	4000 K	3000 K	4000 K
CRI	≥80 (min.)			
Color tolerance	MacAdam 4SDCM			
Service life	L70(4K) > 60500h			
Beam			98°	98°
Efficiency			75%	75%
Efficacy	85,6 lm/W	95,7 lm/W	65 lm/W	74 lm/W

9,5 W	3000 K		α=98°		4000 K		α=98°	
	H _m	Ø _m	E _{Max} _{lux}	E _M _{lux}	H _m	Ø _m	E _{Max} _{lux}	E _M _{lux}
1	2,31	253	79	1	2,31	287	90	
2	4,62	63	20	2	4,62	72	23	
3	6,93	28	9	3	6,93	32	10	
4	9,24	16	5	4	9,24	18	6	
5	11,55	10	3	5	11,55	11	4	

Non dimmable power supply

Independent LED power supply
 Non dimmable.
 Output power: 111 W.
 Supply voltage: 220-240 V.
 Output current: 350 mA. SELV. IP20.
 Insulation class II.
 1 power supply for 1 optic Pad 80

Code
 M074600

Dali dimmable power supply

Independent LED power supply
 Dimmable Dali.
 Output power: 17W.
 Supply voltage: 220-240 V.
 Output current: 350 mA. SELV. IP20.
 Insulation class II.
 1 power supply for 1 optic Pad 80

Code
 M076500

Independent LED power supply
 Non dimmable.
 Output power: 20 W.
 Supply voltage: 220-240 V.
 Output current: 350 mA. SELV. IP20.
 Insulation class II.
 1 power supply for 2 optic Pad 80
 2 power supply for 2x2 optics Pad 80

M076300

Independent LED power supply
 Dimmable Dali-SwitchDim.
 Output power: 35 W.
 Supply voltage: 220-240 V.
 Output current: 350 mA. SELV. IP20.
 Insulation class II.
 1 Alimentatore per 2 o 3 ottiche Pad 80

M076600

Independent LED power supply
 Non dimmable.
 Output power: 35 W.
 Supply voltage: 220-240 V.
 Output current: 350 mA. SELV. IP20.
 Insulation class II.
 1 power supply for 3 optic Pad 80

M076400

Independent LED power supply
 Dimmable Dali.
 Output power: 40 W (2x20 W).
 Supply voltage: 220-240 V.
 Output current: 350 mA. SELV. IP20.
 Insulation class II.
 2 power supply for 2x2 optics Pad 80

M076200



Downlighting	190	Everything
	216	Luceri
	244	Parabola
	258	Rastaf
	264	Toplite
	268	Nothing Downlight
	274	Java Downlight
	278	Zeno UP
	284	Zeno Up Frosted
	288	Hide

Everything

Ernesto Gismondi
2013

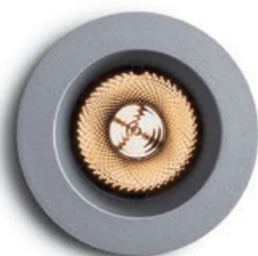
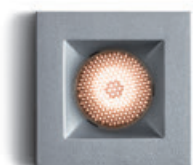



Everything is an innovative range of professional recessed light fittings created to deliver a high lighting performance, with an eye on energy saving and excellent visual comfort. A complete, flexible product range, extremely versatile in its many applications and able to meet challenging lighting performance criteria.

Everything



Everything 35
round-square



Everything 55
round-square

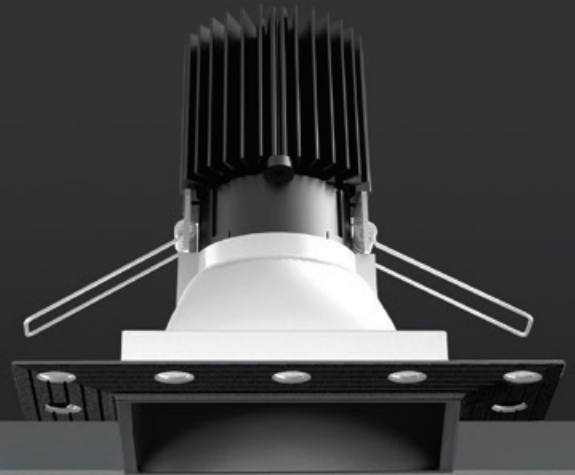

Everything 80
round-square



- 5 dimensions: 35 mm, 55 mm, 80 mm, 105 mm, 150 mm.
- Different options available: professional and standard, fixed or adjustable (excluding Everything 35), round or square.
- LED versions use an optical system based on a hybrid technology (lens and reflector) producing defined beams with high-power LEDs.
- The extruded aluminium heat sink guarantees great thermal management, long life and high efficiency, while providing maximum luminous flux.

- Mono-chromatic emissions in warm white (3000K) and neutral white (4000K) – CRI=80 (min).
- Adjustable versions (excluding Everything 80 option) are equipped with a blocking system to guarantee perfect framing.
- Rotation up to 360°, beam angle +30°/-30°.
- Separate electronic driver: non-dimmable or DALI dimmable options for LED products.
- Compliant with standard EN60598-1 and other specific regulations.



Everything 105
round-square

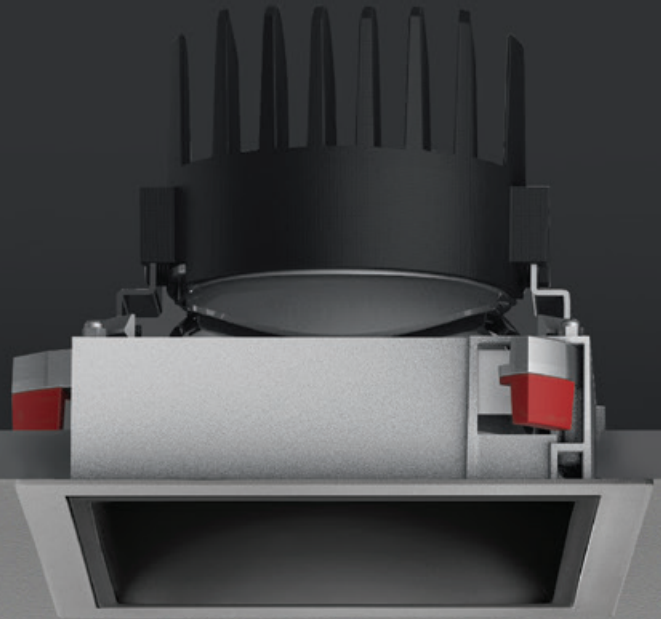

Everything 150
round-square



Everything



Spot

Medium flood

Wide flood



Spot

Medium flood

Wide flood

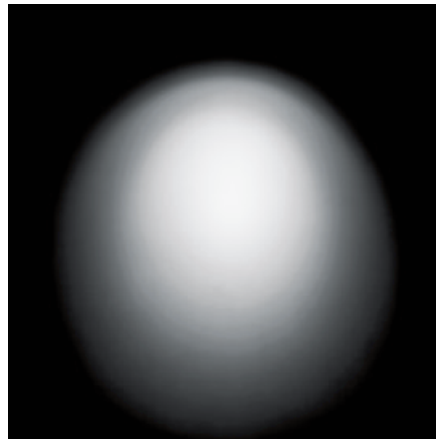
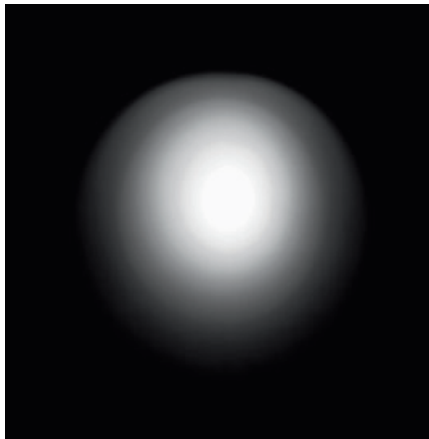
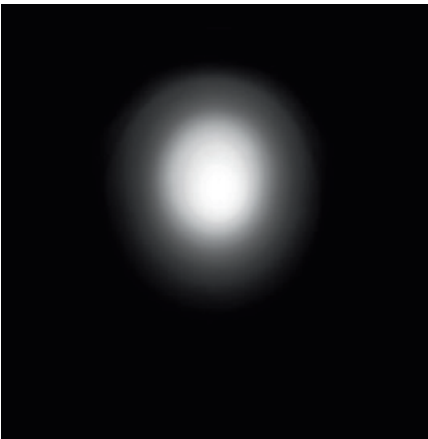



Everything 35

White ○ Black ● Silver ●

Round

W LED	Weight	Beam	Flux	CCT	Color	Code
1,4 W	0,10 kg	14°	98 lm	3000 K	○	NL4203010K006
				4000 K	●	NL4203010K004
			105 lm	○	NL4203010K002	
		24°	98 lm	3000 K	●	NL4203010W006
				4000 K	○	NL4203010W004
			105 lm	○	NL4203010W002	
					●	NL4203025K006
					●	NL4203025K004
					○	NL4203025K002
					○	NL4203025W006
					●	NL4203025W004
					○	NL4203025W002

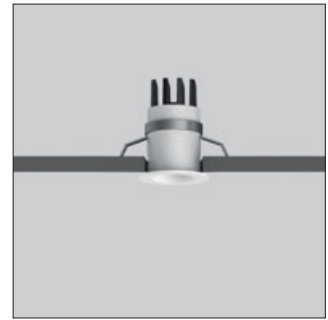

IP20

ø 29 mm

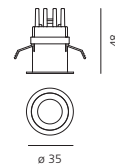

Driver 500 mA SELV supplied separately.

Square

W LED	Weight	Beam	Flux	CCT	Color	Code
1,4 W	0,10 kg	14°	98 lm	3000 K	○	NL4203110K006
				4000 K	●	NL4203110K004
			105 lm	○	NL4203110K002	
		24°	98 lm	3000 K	●	NL4203110W006
				4000 K	○	NL4203110W004
			105 lm	○	NL4203110W002	
					○	NL4203125K006
					●	NL4203125K004
					○	NL4203125K002
					○	NL4203125W006
					●	NL4203125W004
					○	NL4203125W002

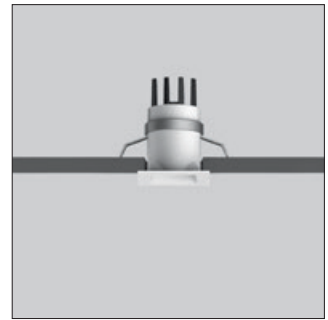

IP20

29 x 29 mm

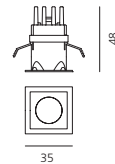

Driver 500 mA SELV supplied separately.

Driver	Vac	Lmm	Wmm	Hmm		Code	
cc 8W 500mA slim	220-240	22	110	19	4max	Non dimmable	NL19041
cc 24W 500mA	220-240	103	67	21	11max	PUSH/1-10V dimmable	M079300
cc 24W 500mA	220-240	103	67	21	11max	DALI dimmable	M079200

Everything 35 14°

	LED		luminaire		1,4 W	3000 K	α=14°	4000 K	α=14°																																								
	Power	Flux	CCT	CRI						H m	Ø m	E lux	H m	Ø m	E lux																																		
Power	1,4 W	1,4 W	1,4 W	1,4 W		<table border="1"> <tr><th>H m</th><th>Ø m</th><th>E lux</th></tr> <tr><td>0,5</td><td>0,12</td><td>4623</td></tr> <tr><td>1,0</td><td>0,24</td><td>1156</td></tr> <tr><td>1,5</td><td>0,36</td><td>514</td></tr> <tr><td>2,0</td><td>0,48</td><td>289</td></tr> <tr><td>2,5</td><td>0,60</td><td>185</td></tr> <tr><td>3,0</td><td>0,72</td><td>128</td></tr> </table>	H m	Ø m	E lux	0,5	0,12	4623	1,0	0,24	1156	1,5	0,36	514	2,0	0,48	289	2,5	0,60	185	3,0	0,72	128	<table border="1"> <tr><th>H m</th><th>Ø m</th><th>E lux</th></tr> <tr><td>0,5</td><td>0,12</td><td>4953</td></tr> <tr><td>1,0</td><td>0,24</td><td>1238</td></tr> <tr><td>1,5</td><td>0,36</td><td>550</td></tr> <tr><td>2,0</td><td>0,48</td><td>310</td></tr> <tr><td>2,5</td><td>0,60</td><td>198</td></tr> <tr><td>3,0</td><td>0,72</td><td>138</td></tr> </table>	H m	Ø m	E lux	0,5	0,12	4953	1,0	0,24	1238	1,5	0,36	550	2,0	0,48	310	2,5	0,60	198	3,0	0,72	138
H m	Ø m	E lux																																															
0,5	0,12	4623																																															
1,0	0,24	1156																																															
1,5	0,36	514																																															
2,0	0,48	289																																															
2,5	0,60	185																																															
3,0	0,72	128																																															
H m	Ø m	E lux																																															
0,5	0,12	4953																																															
1,0	0,24	1238																																															
1,5	0,36	550																																															
2,0	0,48	310																																															
2,5	0,60	198																																															
3,0	0,72	138																																															
Flux	126 lm	134 lm	98 lm	105 lm																																													
CCT	3000 K	4000 K	3000 K	4000 K																																													
Color tolerance	MacAdam 4SDCM																																																
Service life	L70(GK) > 39000h																																																
Beam			14°	14°																																													
Efficiency			78%	78%																																													
Efficacy	90 lm/W	60 lm/W	70 lm/W	75 lm/W																																													

Everything 35 24°

	LED		luminaire		1,4 W	3000 K	α=24°	4000 K	α=24°																																								
	Power	Flux	CCT	CRI						H m	Ø m	E lux	H m	Ø m	E lux																																		
Power	1,4 W	1,4 W	1,4 W	1,4 W		<table border="1"> <tr><th>H m</th><th>Ø m</th><th>E lux</th></tr> <tr><td>0,5</td><td>0,21</td><td>1878</td></tr> <tr><td>1,0</td><td>0,42</td><td>470</td></tr> <tr><td>1,5</td><td>0,63</td><td>209</td></tr> <tr><td>2,0</td><td>0,84</td><td>117</td></tr> <tr><td>2,5</td><td>1,04</td><td>75</td></tr> <tr><td>3,0</td><td>1,25</td><td>52</td></tr> </table>	H m	Ø m	E lux	0,5	0,21	1878	1,0	0,42	470	1,5	0,63	209	2,0	0,84	117	2,5	1,04	75	3,0	1,25	52	<table border="1"> <tr><th>H m</th><th>Ø m</th><th>E lux</th></tr> <tr><td>0,5</td><td>0,21</td><td>2012</td></tr> <tr><td>1,0</td><td>0,42</td><td>503</td></tr> <tr><td>1,5</td><td>0,63</td><td>224</td></tr> <tr><td>2,0</td><td>0,84</td><td>126</td></tr> <tr><td>2,5</td><td>1,04</td><td>80</td></tr> <tr><td>3,0</td><td>1,25</td><td>56</td></tr> </table>	H m	Ø m	E lux	0,5	0,21	2012	1,0	0,42	503	1,5	0,63	224	2,0	0,84	126	2,5	1,04	80	3,0	1,25	56
H m	Ø m	E lux																																															
0,5	0,21	1878																																															
1,0	0,42	470																																															
1,5	0,63	209																																															
2,0	0,84	117																																															
2,5	1,04	75																																															
3,0	1,25	52																																															
H m	Ø m	E lux																																															
0,5	0,21	2012																																															
1,0	0,42	503																																															
1,5	0,63	224																																															
2,0	0,84	126																																															
2,5	1,04	80																																															
3,0	1,25	56																																															
Flux	126 lm	134 lm	98 lm	105 lm																																													
CCT	3000 K	4000 K	3000 K	4000 K																																													
Color tolerance	MacAdam 4SDCM																																																
Service life	L70(GK) > 39000h																																																
Beam			24°	24°																																													
Efficiency			78%	78%																																													
Efficacy	90 lm/W	96 lm/W	70 lm/W	75 lm/W																																													

Round

W LED	Weight	Beam	Flux	CCT	Color
6,4 W	0,20 kg	20°	475 lm	3000 K	○
					●
					●
		34°	513 lm	4000 K	○
					●
					●
8,5 W	0,30 kg	20°	634 lm	3000 K	○
					●
					●
		34°	684 lm	4000 K	○
					●
					●
6,4 W	0,20 kg	20°	475 lm	3000 K	○
					●
					●
		34°	513 lm	4000 K	○
					●
					●
8,5 W	0,30 kg	20°	634 lm	3000 K	○
					●
					●
		34°	589 lm	3000 K	○
					●
					●
6,4 W	0,20 kg	20°	475 lm	3000 K	○
					●
					●
		34°	442 lm	3000 K	○
					●
					●
8,5 W	0,30 kg	20°	634 lm	3000 K	○
					●
					●
		34°	476 lm	4000 K	○
					●
					●

Fixed

Code
NL4203518K006
NL4203518K004
NL4203518K002
NL4203518W006
NL4203518W004
NL4203518W002
NL4203534K006
NL4203534K004
NL4203534K002
NL4203534W006
NL4203534W004
NL4203534W002
NL4204118K006
NL4204118K004
NL4204118K002
NL4204118W006
NL4204118W004
NL4204118W002
NL4204134K006
NL4204134K004
NL4204134K002
NL4204134W006
NL4204134W004
NL4204134W002

Adjustable

Code
NL4203318K006
NL4203318K004
NL4203318K002
NL4203318W006
NL4203318W004
NL4203318W002
NL4203334K006
NL4203334K004
NL4203334K002
NL4203334W006
NL4203334W004
NL4203334W002



IP20

Ø 50 mm

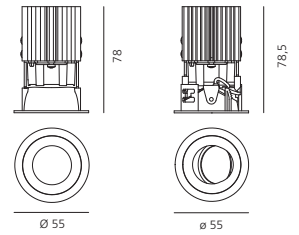

30°

Driver 500/700 mA SELV supplied separately.

Square

W LED	Weight	Beam	Flux	CCT	Color
6,4 W	0,20 kg	20°	475 lm	3000 K	○
					●
					●
		34°	513 lm	4000 K	○
					●
					●
8,5 W	0,30 kg	20°	634 lm	3000 K	○
					●
					●
		34°	684 lm	4000 K	○
					●
					●
6,4 W	0,20 kg	20°	475 lm	3000 K	○
					●
					●
		34°	589 lm	3000 K	○
					●
					●
8,5 W	0,30 kg	20°	634 lm	3000 K	○
					●
					●
		34°	589 lm	3000 K	○
					●
					●
6,4 W	0,20 kg	20°	475 lm	3000 K	○
					●
					●
		34°	442 lm	3000 K	○
					●
					●
8,5 W	0,30 kg	20°	634 lm	3000 K	○
					●
					●
		34°	476 lm	4000 K	○
					●
					●

Fixed

Code
NL4203418K006
NL4203418K004
NL4203418K002
NL4203418W006
NL4203418W004
NL4203418W002
NL4203434K006
NL4203434K004
NL4203434K002
NL4203434W006
NL4203434W004
NL4203434W002
NL4204218K006
NL4204218K004
NL4204218K002
NL4204218W006
NL4204218W004
NL4204218W002
NL4204234K006
NL4204234K004
NL4204234K002
NL4204234W006
NL4204234W004
NL4204234W002

Adjustable

Code
NL4203218K006
NL4203218K004
NL4203218K002
NL4203218W006
NL4203218W004
NL4203218W002
NL4203234K006
NL4203234K004
NL4203234K002
NL4203234W006
NL4203234W004
NL4203234W002

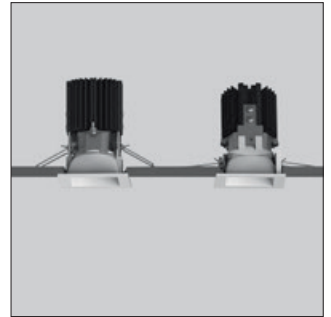

IP20

50 x 50 mm

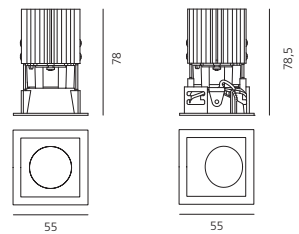

30°

Driver 500/700 mA SELV supplied separately.

Driver	Vac	L _{mm}	W _{mm}	H _{mm}		Code
cc 15W 500mA	220-240	150	22	19	2max	Everything 55 - 6,4W Non dimmable M077900
cc 20W 700mA	220-240	125	38	23	1max	Everything 55 - 8,5W Non dimmable NL19036
cc 24W 500mA	220-240	103	67	21	3max	Everything 55 - 6,4W PUSH/1-10V dimmable M079300
cc 32W 500mA	220-240	103	67	21	3max	Everything 55 - 8,5W PUSH/1-10V dimmable M079300
cc 24W 500mA	220-240	103	67	21	3max	Everything 55 - 6,4W DALI dimmable M079200
cc 32W 500mA	220-240	103	67	21	3max	Everything 55 - 8,5W DALI dimmable M079200

Everything 55 20°	LED		luminaire		6,4 W	3000 K	$\alpha=20^\circ$	4000 K	$\alpha=20^\circ$		
Power	6,4 W	6,4 W	6,4 W	6,4 W		H m	\varnothing C0 m	E lux	H m	\varnothing C0 m	E lux
Flux	566 lm	610 lm	475 lm	513 lm		0,5	0,17	15343	0,5	0,17	16568
CCT	3000 K	4000 K	3000 K	4000 K		1,0	0,35	3836	1,0	0,35	4142
CRI	=80 (min.)					1,5	0,52	1705	1,5	0,52	1841
Color tolerance	MacAdam 2SDCM					2,0	0,70	959	2,0	0,70	1035
Service life	L70(6K) > 51,400h					2,5	0,87	614	2,5	0,87	663
Beam			20°	20°	3,0	1,05	426	3,0	1,05	460	
Efficiency	89 lm/W	96 lm/W	75 lm/W	81 lm/W							

Everything 55 34°	LED		luminaire		6,4 W	3000 K	$\alpha=34^\circ$	4000 K	$\alpha=34^\circ$		
Power	6,4 W	6,4 W	6,4 W	6,4 W		H m	\varnothing C0 m	E lux	H m	\varnothing C0 m	E lux
Flux	566 lm	610 lm	442 lm	476 lm		0,5	0,31	4976	0,5	0,31	5359
CCT	3000 K	4000 K	3000 K	4000 K		1,0	0,61	1244	1,0	0,61	1340
CRI	=80 (min.)					1,5	0,92	553	1,5	0,92	595
Color tolerance	MacAdam 2SDCM					2,0	1,22	311	2,0	1,22	335
Service life	L70(6K) > 51,400h					2,5	1,53	199	2,5	1,53	214
Beam			34°	34°	3,0	1,83	138	3,0	1,83	149	
Efficiency	89 lm/W	96 lm/W	69 lm/W	75 lm/W							

Everything 55 20°	LED		luminaire		8,5 W	3000 K	$\alpha=20^\circ$	4000 K	$\alpha=20^\circ$		
Power	8,5 W	8,5 W	8,5 W	8,5 W		H m	\varnothing C0 m	E lux	H m	\varnothing C0 m	E lux
Flux	755 lm	813 lm	634 lm	684 lm		0,5	0,17	20436	0,5	0,17	22079
CCT	3000 K	4000 K	3000 K	4000 K		1,0	0,35	5109	1,0	0,35	5520
CRI	=80 (min.)					1,5	0,52	2271	1,5	0,52	2453
Color tolerance	MacAdam 2SDCM					2,0	0,70	1277	2,0	0,70	1380
Service life	L70(6K) > 51,400h					2,5	0,87	817	2,5	0,87	883
Beam			20°	20°	3,0	1,05	273	3,0	1,05	613	
Efficiency	89 lm/W	96 lm/W	75 lm/W	81 lm/W							

Everything 55 34°	LED		luminaire		8,5 W	3000 K	$\alpha=34^\circ$	4000 K	$\alpha=34^\circ$		
Power	8,5 W	8,5 W	8,5 W	8,5 W		H m	\varnothing C0 m	E lux	H m	\varnothing C0 m	E lux
Flux	755 lm	813 lm	589 lm	634 lm		0,5	0,31	6631	0,5	0,31	7137
CCT	3000 K	4000 K	3000 K	4000 K		1,0	0,61	1658	1,0	0,61	1784
CRI	=80 (min.)					1,5	0,92	737	1,5	0,92	793
Color tolerance	MacAdam 2SDCM					2,0	1,22	414	2,0	1,22	446
Service life	L70(6K) > 51,400h					2,5	1,53	265	2,5	1,53	285
Beam			34°	34°	3,0	1,83	184	3,0	1,83	198	
Efficiency	89 lm/W	96 lm/W	69 lm/W	75 lm/W							

Everything 80 round

White ○ Black ● Silver ● Polished metal ●

Trim						
W LED	Weight	Beam	Flux	CCT	Trim	Deflector
12 W	0,24 kg	20°	998 lm	3000 K	○ ○	○ ○
					● ●	● ●
					○ ●	○ ●
					○ ○	○ ○
					● ●	● ●
		1048 lm	4000 K	○ ○	○ ○	
				● ●	● ●	
				○ ●	○ ●	
				○ ○	○ ○	
				● ●	● ●	
		24°	901 lm	3000 K	○ ○	○ ○
					● ●	● ●
					○ ●	○ ●
					○ ○	○ ○
					● ●	● ●
946 lm	4000 K	○ ○	○ ○			
		● ●	● ●			
		○ ●	○ ●			
		○ ○	○ ○			
		● ●	● ●			
48°	796 lm	3000 K	○ ○	○ ○		
			● ●	● ●		
			○ ●	○ ●		
			○ ○	○ ○		
			● ●	● ●		
		836 lm	4000 K	○ ○	○ ○	
				● ●	● ●	
				○ ●	○ ●	
				○ ○	○ ○	
				● ●	● ●	

Fixed
Code
M251020
M278610
M278620
M251620
M251610
M251660
M251120
M278710
M278720
M251720
M251710
M251760
M251220
M278810
M278820
M251820
M251810
M251860
M251320
M278910
M278920
M251920
M251910
M251960
M251420
M279010
M279020
M252020
M252010
M252060
M251520
M279110
M279120
M252120
M252110
M252160

Adjustable
Code
M251025
M278615
M278625
M251625
M251615
M251665
M251125
M278715
M278725
M251725
M251715
M251765
M251225
M278815
M278825
M251825
M251815
M251865
M251325
M278915
M278925
M251925
M251915
M251965
M251425
M279015
M279025
M252025
M252015
M252065
M251525
M279115
M279125
M252125
M252115
M252165

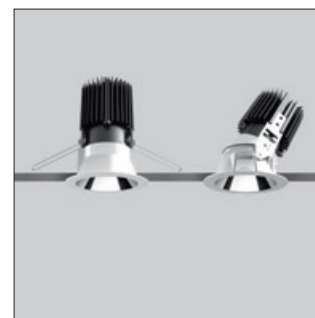

▼ IP20 / ▲ IP44 ⚡
850° ⌀ 67 mm

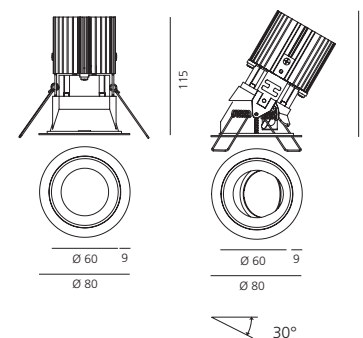

Driver 350mA SELV supplied separately.

Trimless						
W LED	Weight	Beam	Flux	CCT	Deflector	
12 W	0,24 kg	20°	998 lm	3000 K	○	○
					●	●
					○ ●	○ ●
					○ ○	○ ○
					● ●	● ●
		1048 lm	4000 K	○	○	
				●	●	
				○ ●	○ ●	
				○ ○	○ ○	
				● ●	● ●	
		24°	901 lm	3000 K	○	○
					●	●
					○ ●	○ ●
					○ ○	○ ○
					● ●	● ●
946 lm	4000 K	○	○			
		●	●			
		○ ●	○ ●			
		○ ○	○ ○			
		● ●	● ●			
48°	796 lm	3000 K	○	○		
			●	●		
			○ ●	○ ●		
			○ ○	○ ○		
			● ●	● ●		
		836 lm	4000 K	○	○	
				●	●	
				○ ●	○ ●	
				○ ○	○ ○	
				● ●	● ●	

Fixed
Code
M252200
M252800
M279200
M252300
M252900
M279300
M252400
M253000
M279400
M252500
M253100
M279500
M252600
M253200
M279600
M252700
M253300
M279700

Adjustable
Code
M252205
M252805
M279205
M252305
M252905
M279305
M252405
M253005
M279405
M252505
M253105
M279505
M252605
M253205
M279605
M252705
M253305
M279705

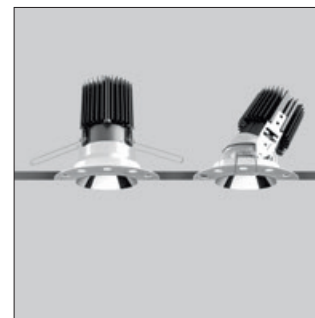

▼ IP20 / ▲ IP44 ⚡
850° ⌀ 67 mm

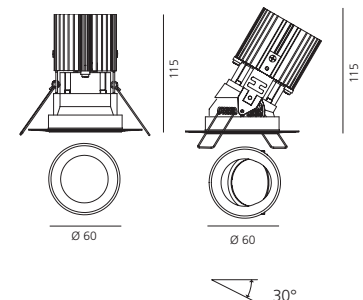

Driver 350mA SELV supplied separately.

Driver	Vac	L _{mm}	W _{mm}	H _{mm}	
cc 15W 350mA	220-240	125	38	23	1max Non dimmable
cc 16W 350mA	220-240	156	52	26	1max DALI/PUSH/0-10V dimmable

Code
M077500
M077401

Everything 80 square

White ○ Black ● Silver ● Polished metal ●

Trim						
W LED	Weight	Beam	Flux	CCT	Trim	Deflector
12 W	0,24 kg	20°	998 lm	3000 K	○	○
					●	●
					○	●
					○	○
					●	●
					●	●
		1048 lm	4000 K	○	○	
				●	●	
				○	○	
				○	●	
				●	●	
				●	●	
24°	901 lm	3000 K	3000 K	○	○	
				●	●	
				○	○	
				○	●	
				○	○	
				○	○	
		946 lm	4000 K	○	○	
				●	●	
				○	○	
				○	●	
				●	●	
				●	●	
48°	796 lm	3000 K	3000 K	○	○	
				●	●	
				○	○	
				○	●	
				○	○	
				○	○	
		836 lm	4000 K	○	○	
				●	●	
				○	○	
				○	●	
				●	●	
				●	●	

Fixed	
Code	
M253420	○
M273610	○
M273620	○
M254020	○
M254010	●
M254060	●
M253520	○
M273710	○
M273720	○
M254120	○
M254110	●
M254160	●
M253620	○
M273810	○
M273820	○
M254220	○
M254210	●
M254260	●
M253720	○
M273910	○
M273920	○
M254320	○
M254310	●
M254360	●
M253820	○
M274010	○
M274020	○
M254420	○
M254410	●
M254460	●
M253920	○
M274110	○
M274120	○
M254520	○
M254510	●
M254560	●

Adjustable	
Code	
M253425	○
M273615	○
M273625	○
M254025	○
M254015	●
M254065	●
M253525	○
M273715	○
M273725	○
M254125	○
M254115	●
M254165	●
M253625	○
M273815	○
M273825	○
M254225	○
M254215	●
M254265	●
M253725	○
M273915	○
M273925	○
M254325	○
M254315	●
M254365	●
M253825	○
M274015	○
M274025	○
M254425	○
M254415	●
M254465	●
M253925	○
M274115	○
M274125	○
M254525	○
M254515	●
M254565	●



▼ IP20 / ▲ IP44 850° 67 x 67 mm

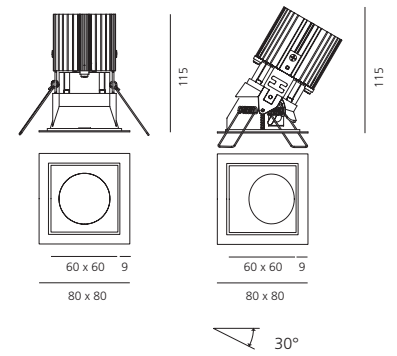

Driver 350mA SELV supplied separately.

Trimless					
W LED	Weight	Beam	Flux	CCT	Deflector
12 W	0,24 kg	20°	998 lm	3000 K	○
					●
					○
					○
					●
					●
		1048 lm	4000 K	○	
				●	
				○	
				○	
				●	
				●	
24°	901 lm	3000 K	3000 K	○	
				●	
				○	
				○	
				○	
				○	
		946 lm	4000 K	○	
				●	
				○	
				○	
				●	
				●	
48°	796 lm	3000 K	3000 K	○	
				●	
				○	
				○	
				○	
				○	
		836 lm	4000 K	○	
				●	
				○	
				○	
				●	
				●	

Fixed	
Code	
M254600	○
M255200	○
M274200	○
M254700	○
M255300	○
M274300	○
M254800	○
M255400	○
M274400	○
M254900	○
M255500	○
M274500	○
M255000	○
M255600	○
M274600	○
M255100	○
M255700	○
M274700	○

Adjustable	
Code	
M254605	○
M255205	○
M274205	○
M254705	○
M255305	○
M274305	○
M254805	○
M255405	○
M274405	○
M254905	○
M255505	○
M274505	○
M255005	○
M255605	○
M274605	○
M255105	○
M255705	○
M274705	○



▼ IP20 / ▲ IP44 850° 67 x 67 mm

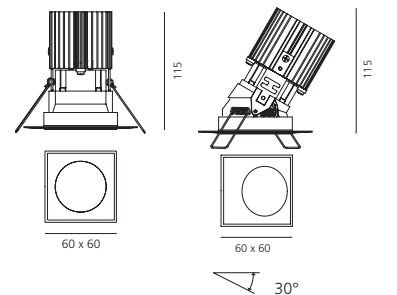

Driver 350mA SELV supplied separately.

Driver	Vac	L _{mm}	W _{mm}	H _{mm}		
cc 15W 350mA	220-240	125	38	23	1max	Non dimmable
cc 16W 350mA	220-240	156	52	26	1max	DALI dimmable

Code	
M077500	○
M077401	○

Everything 20°

LED	luminaire			
Power	12 W	12 W	12 W	12 W
Flux	1229 lm	1291 lm	998 lm	1048 lm
CCT	3000 K	4000 K	3000 K	4000 K
CRI	=80 (min.)			
Color tolerance	MacAdam 3SDCM			
Service life	L70(6K) > 54000h			
Beam			20°	20°
Efficiency			81,2%	81,2%
Efficacy	98,3 lm/W	103,29 lm/W	79,9 lm/W	83,87 lm/W

12 W	3000 K		α=20°		4000 K		α=20°	
H m	Ø m	E _{Max} lux	E _M lux	H m	Ø m	E _{Max} lux	E _M lux	
1	0,35	4178	2625	1	0,35	4275	2686	
2	0,71	1044	656	2	0,71	1069	671	
3	1,06	464	292	3	1,06	475	298	
4	1,41	261	164	4	1,41	267	168	
5	1,77	167	105	5	1,77	171	107	

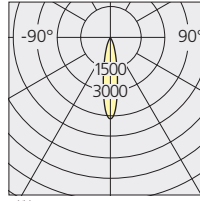

Everything 24°

LED	luminaire			
Power	12 W	12 W	12 W	12 W
Flux	1229 lm	1291 lm	901 lm	946 lm
CCT	3000 K	4000 K	3000 K	4000 K
CRI	=80 (min.)			
Color tolerance	MacAdam 3SDCM			
Service life	L70(6K) > 54000h			
Beam			24°	24°
Efficiency			73,3%	73,3%
Efficacy	98,3 lm/W	103,29 lm/W	72,1 lm/W	75,68 lm/W

12 W	3000 K		α=24°		4000 K		α=24°	
H m	Ø m	E _{Max} lux	E _M lux	H m	Ø m	E _{Max} lux	E _M lux	
1	0,43	2714	1677	1	0,43	2777	1716	
2	0,87	679	419	2	0,87	694	429	
3	1,30	302	186	3	1,30	309	191	
4	1,74	170	105	4	1,74	174	107	
5	2,17	109	67	5	2,17	111	69	

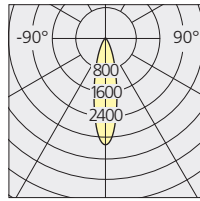

Everything 48°

LED	luminaire			
Power	12 W	12 W	12 W	12 W
Flux	1229 lm	1291 lm	796 lm	836 lm
CCT	3000 K	4000 K	3000 K	4000 K
CRI	=80 (min.)			
Color tolerance	MacAdam 3SDCM			
Service life	L70(6K) > 54000h			
Beam			48°	48°
Efficiency			64,8%	64,8%
Efficacy	98,3 lm/W	103,29 lm/W	63,8 lm/W	66,9 lm/W

12 W	3000 K		α=48°		4000 K		α=48°	
H m	Ø m	E _{Max} lux	E _M lux	H m	Ø m	E _{Max} lux	E _M lux	
1	0,91	903	497	1	0,91	924	509	
2	1,81	226	124	2	1,81	231	127	
3	2,72	100	55	3	2,72	103	57	
4	3,63	56	31	4	3,63	58	32	
5	4,54	36	20	5	4,54	37	20	

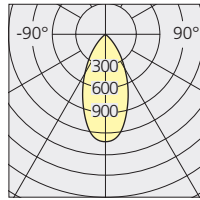

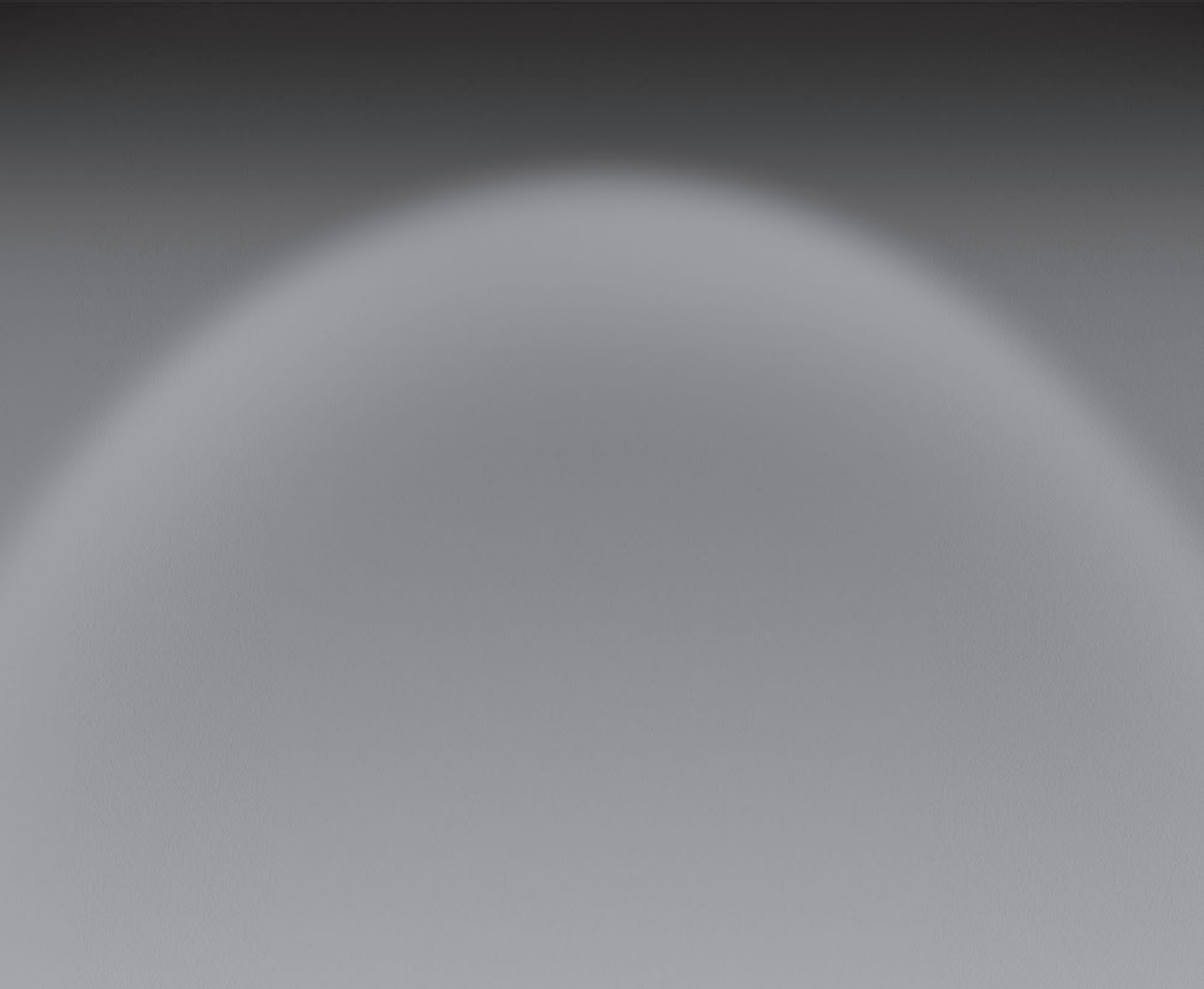



Everything 105 trim

White ○ Black ● Silver ● Polished metal ●

Round						
W LED	Weight	Beam	Flux	CCT	Trim	Deflector
12 W	0,30 kg	20°	998 lm	3000 K	○ ●	○ ●
					○ ●	○ ●
					○ ●	○ ●
			1048 lm	4000 K	○ ●	○ ●
					○ ●	○ ●
					○ ●	○ ●
		24°	901 lm	3000 K	○ ●	○ ●
					○ ●	○ ●
					○ ●	○ ●
			946 lm	4000 K	○ ●	○ ●
					○ ●	○ ●
					○ ●	○ ●
48°	796 lm	3000 K	○ ●	○ ●		
			○ ●	○ ●		
			○ ●	○ ●		
	836 lm	4000 K	○ ●	○ ●		
			○ ●	○ ●		
			○ ●	○ ●		

Fixed	
Code	
M255820	
M255860	
M256420	
M256460	
M255920	
M255960	
M256520	
M256560	
M256020	
M256060	
M256620	
M256660	
M256120	
M256160	
M256720	
M256760	
M256220	
M256260	
M256320	
M256360	

Adjustable	
Code	
M255825	
M255865	
M256425	
M256465	
M255925	
M255965	
M256525	
M256565	
M256025	
M256065	
M256625	
M256665	
M256125	
M256165	
M256725	
M256765	
M256225	
M256265	
M256325	
M256365	



▼ IP20 / ▲ IP44 ⚡ 850° ⌀ 92 mm

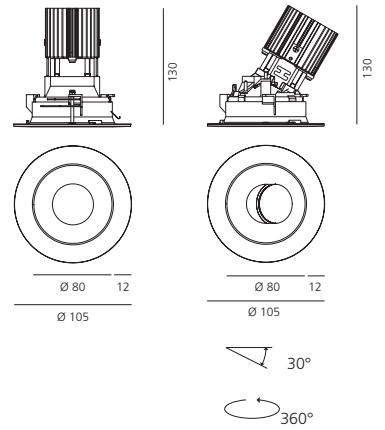

Driver 350mA SELV supplied separately.

Square						
W LED	Weight	Beam	Flux	CCT	Trim	Deflector
12 W	0,30 kg	20°	998 lm	3000 K	○ ●	○ ●
					○ ●	○ ●
					○ ●	○ ●
			996 lm	4000 K	○ ●	○ ●
					○ ●	○ ●
					○ ●	○ ●
		24°	901 lm	3000 K	○ ●	○ ●
					○ ●	○ ●
					○ ●	○ ●
			946 lm	4000 K	○ ●	○ ●
					○ ●	○ ●
					○ ●	○ ●
48°	796 lm	3000 K	○ ●	○ ●		
			○ ●	○ ●		
			○ ●	○ ●		
	836 lm	4000 K	○ ●	○ ●		
			○ ●	○ ●		
			○ ●	○ ●		

Fixed	
Code	
M258220	
M258260	
M258820	
M258860	
M258320	
M258360	
M258920	
M258960	
M258420	
M258460	
M259020	
M259060	
M258520	
M258560	
M259120	
M259160	
M258620	
M258660	
M258720	
M258760	

Adjustable	
Code	
M258225	
M258265	
M258825	
M258865	
M258325	
M258365	
M258925	
M258965	
M258425	
M258465	
M259025	
M259065	
M258525	
M258565	
M259125	
M259165	
M258625	
M258665	
M258725	
M258765	

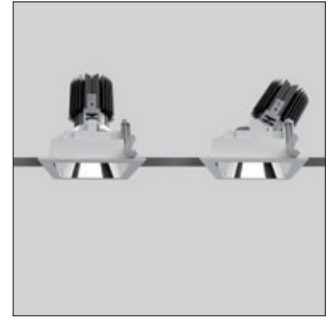

▼ IP20 / ▲ IP44 ⚡ 850° 92 x 92 mm

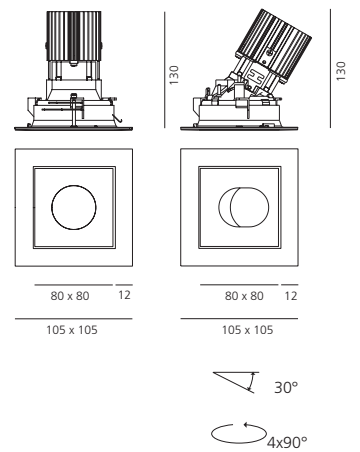

Driver 350mA SELV supplied separately.

Driver	Vac	L _{mm}	W _{mm}	H _{mm}		
cc 15W 350mA	220-240	125	38	23	1max	Non dimmable
cc 16W 350mA	220-240	156	52	26	1max	DALI dimmable

Code	
M077500	
M077401	

Everything 105 Kit trimless

Black ● Polished metal ○

Round optical unit: trimless

W LED	Weight	Beam	Flux	CCT	Deflector
12 W	0,30 kg	20°	998 lm	3000 K	●
			1048 lm	4000 K	○
		24°	901 lm	3000 K	●
			946 lm	4000 K	○
		48°	796 lm	3000 K	●
			836 lm	4000 K	●

Fixed

Code
M257000
M257600
M257100
M257700
M257200
M257800
M257300
M257900
M257400
M257500

Adjustable

Code
M257005
M257605
M257105
M257705
M257205
M257805
M257305
M257905
M257405
M257505

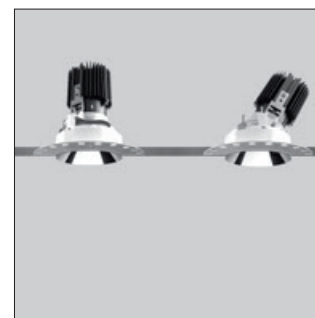

▼ IP20 / ▲ IP44 ⚡
850°

○
ø 92 mm

Driver 350mA SELV supplied separately.

Fitting to be completed with installation frame for recessing into ceiling.

Frame

Round frame
for recessed installation

Code
M273400

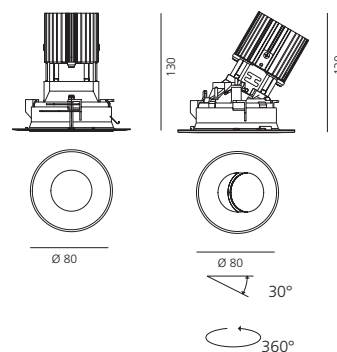

Square optical unit: trimless

W LED	Weight	Beam	Flux	CCT	Deflector
12 W	0,30 kg	20°	998 lm	3000 K	●
			1048 lm	4000 K	○
		24°	901 lm	3000 K	●
			946 lm	4000 K	○
		48°	796 lm	3000 K	●
			836 lm	4000 K	●

Fixed

Code
M259400
M260000
M259500
M260100
M259600
M260200
M259700
M260300
M259800
M259900

Adjustable

Code
M259405
M260005
M259505
M260105
M259605
M260205
M259705
M260305
M259805
M259905

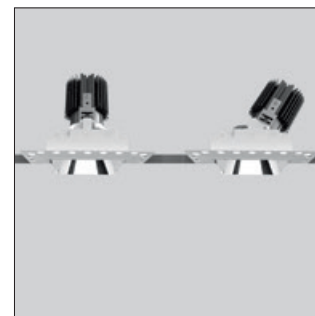

▼ IP20 / ▲ IP44 ⚡
850°

□
92 x 92 mm

Driver 350mA SELV supplied separately.

Fitting to be completed with installation frame for recessing into ceiling.

Frame

Square frame
for recessed installation

Code
M273500

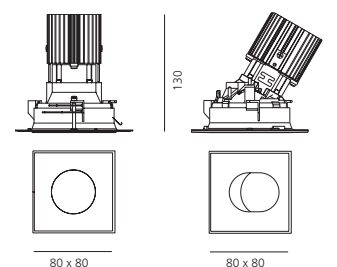
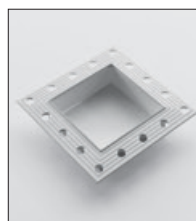

Driver	Vac	L _{mm}	W _{mm}	H _{mm}		Code
cc 15W 350mA	220-240	125	38	23	1max	Non dimmable M077500
cc 16W 350mA	220-240	156	52	26	1max	DALI dimmable M077401

△ 30°
↻ 4x90°

Everything 105 Kit trim

Black ● Polished metal ●

Round optical unit: trimless

W LED	Weight	Beam	Flux	CCT	Deflector
12 W	0,30 kg	20°	998 lm	3000 K	●
			1048 lm	4000 K	●
		24°	901 lm	3000 K	●
			946 lm	4000 K	●
		48°	796 lm	3000 K	●
			836 lm	4000 K	●

Fixed

Code
M257000
M257600
M257100
M257700
M257200
M257800
M257300
M257900
M257400
M257500

Adjustable

Code
M257005
M257605
M257105
M257705
M257205
M257805
M257305
M257905
M257405
M257505



▼ IP20 / ▲ IP44 ⬢
850°

⤵
ø 92 mm

Driver 350mA SELV supplied separately.

Fitting to be completed with installation frame for recessing into ceiling.

Frame

Color
○
●

Round frame
for recessed installation

Code
M286020
M286060

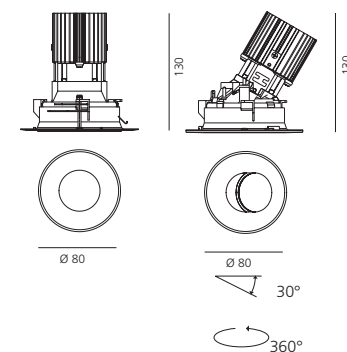

Square optical unit: trimless

W LED	Weight	Beam	Flux	CCT	Deflector
12 W	0,30 kg	20°	998 lm	3000 K	●
			1048 lm	4000 K	●
		24°	901 lm	3000 K	●
			946 lm	4000 K	●
		48°	796 lm	3000 K	●
			836 lm	4000 K	●

Fixed

Code
M259400
M260000
M259500
M260100
M259600
M260200
M259700
M260300
M259800
M259900

Adjustable

Code
M259405
M260005
M259505
M260105
M259605
M260205
M259705
M260305
M259805
M259905

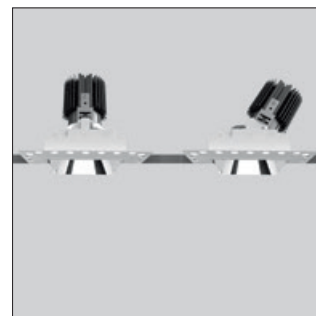

▼ IP20 / ▲ IP44 ⬢
850°

⏏
92 x 92 mm

Driver 350mA SELV supplied separately.

Fitting to be completed with installation frame for recessing into ceiling.

Frame

Color
○
●

Square frame
for recessed installation

Code
M286120
M286160

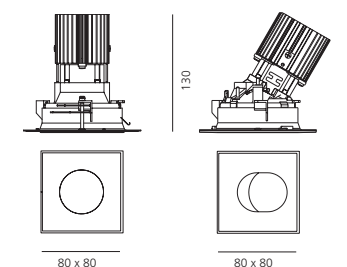
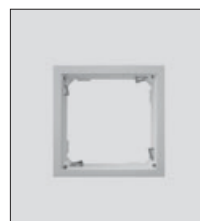

Driver	Vac	L _{mm}	W _{mm}	H _{mm}		
cc 15W 350mA	220-240	125	38	23	1max	Non dimmable
cc 16W 350mA	220-240	156	52	26	1max	DALI dimmable

Code
M077500
M077401

⤵ 30°
⤵ 4x90°

Everything 20°

LED	luminaire			
Power	12 W	12 W	12 W	12 W
Flux	1229 lm	1291 lm	998 lm	1048 lm
CCT	3000 K	4000 K	3000 K	4000 K
CRI	=80 (min.)			
Color tolerance	MacAdam 3SDCM			
Service life	L70(6K) > 54000h			
Beam			20°	20°
Efficiency			81,2%	81,2%
Efficacy	98,3 lm/W	103,29 lm/W	79,9 lm/W	83,87 lm/W

12 W	3000 K		$\alpha=20^\circ$		4000 K		$\alpha=20^\circ$	
H m	\varnothing m	E _{Max} lux	E _M lux	H m	\varnothing m	E _{Max} lux	E _M lux	
1	0,35	4178	2625	1	0,35	4275	2686	
2	0,71	1044	656	2	0,71	1069	671	
3	1,06	464	292	3	1,06	475	298	
4	1,41	261	164	4	1,41	267	168	
5	1,77	167	105	5	1,77	171	107	

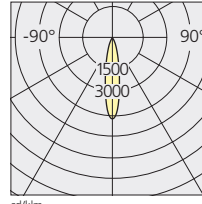

Everything 24°

LED	luminaire			
Power	12 W	12 W	12 W	12 W
Flux	1229 lm	1291 lm	901 lm	946 lm
CCT	3000 K	4000 K	3000 K	4000 K
CRI	=80 (min.)			
Color tolerance	MacAdam 3SDCM			
Service life	L70(6K) > 54000h			
Beam			24°	24°
Efficiency			73,3%	73,3%
Efficacy	98,3 lm/W	103,29 lm/W	72,1 lm/W	75,68 lm/W

12 W	3000 K		$\alpha=24^\circ$		4000 K		$\alpha=24^\circ$	
H m	\varnothing m	E _{Max} lux	E _M lux	H m	\varnothing m	E _{Max} lux	E _M lux	
1	0,43	2714	1677	1	0,43	2777	1716	
2	0,87	679	419	2	0,87	694	429	
3	1,30	302	186	3	1,30	309	191	
4	1,74	170	105	4	1,74	174	107	
5	2,17	109	67	5	2,17	111	69	

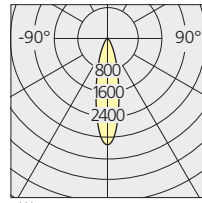

Everything 48°

LED	luminaire			
Power	12 W	12 W	12 W	12 W
Flux	1229 lm	1291 lm	796 lm	836 lm
CCT	3000 K	4000 K	3000 K	4000 K
CRI	=80 (min.)			
Color tolerance	MacAdam 3SDCM			
Service life	L70(6K) > 54000h			
Beam			48°	48°
Efficiency			64,8%	64,8%
Efficacy	98,3 lm/W	103,29 lm/W	63,8 lm/W	66,9 lm/W

12 W	3000 K		$\alpha=48^\circ$		4000 K		$\alpha=48^\circ$	
H m	\varnothing m	E _{Max} lux	E _M lux	H m	\varnothing m	E _{Max} lux	E _M lux	
1	0,91	903	497	1	0,91	924	509	
2	1,81	226	124	2	1,81	231	127	
3	2,72	100	55	3	2,72	103	57	
4	3,63	56	31	4	3,63	58	32	
5	4,54	36	20	5	4,54	37	20	

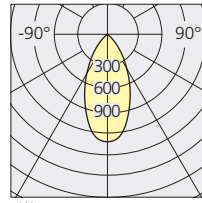



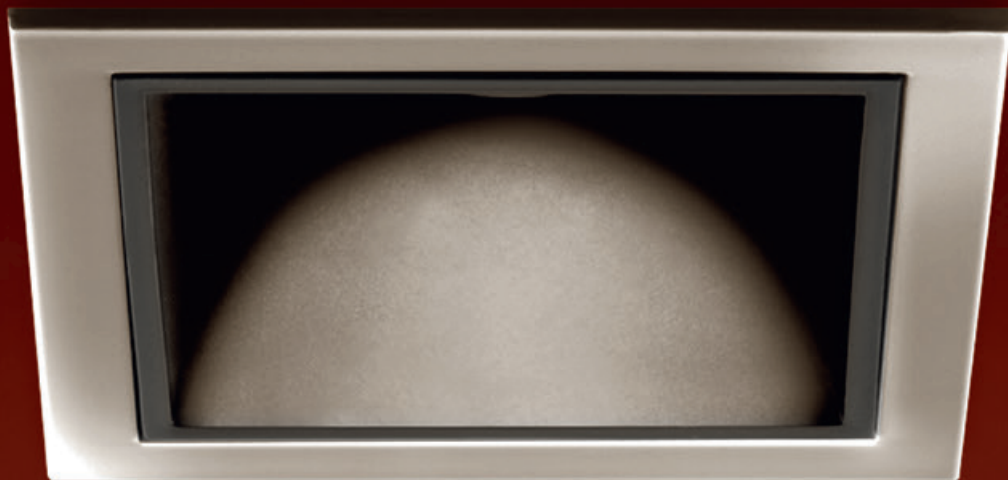

Everything 150 trim

White ○ Black ● Silver ● Polished metal ●

Round						
W LED	Weight	Beam	Flux	CCT	Trim	Deflector
24,4 W	0,30 kg	18°	1860 lm	3000 K	○ ●	○ ●
					○ ●	○ ●
					○ ●	○ ●
					○ ●	○ ●
		1940 lm	4000 K	○ ●	○ ●	
				○ ●	○ ●	
				○ ●	○ ●	
				○ ●	○ ●	
		28°	1640 lm	3000 K	○ ●	○ ●
					○ ●	○ ●
					○ ●	○ ●
					○ ●	○ ●
1710 lm	4000 K	○ ●	○ ●			
		○ ●	○ ●			
		○ ●	○ ●			
		○ ●	○ ●			
46°	1520 lm	3000 K	○ ●	○ ●		
			○ ●	○ ●		
			○ ●	○ ●		
			○ ●	○ ●		
1590 lm	4000 K	○ ●	○ ●			
		○ ●	○ ●			
		○ ●	○ ●			
		○ ●	○ ●			

Fixed	
Code	
M260620	
M260660	
M261220	
M261260	
M260720	
M260760	
M261320	
M261360	
M260820	
M260860	
M261620	
M261660	
M260920	
M260960	
M261720	
M261760	
M261020	
M261060	
M261120	
M261160	

Adjustable	
Code	
M260625	
M260665	
M261225	
M261265	
M260725	
M260765	
M261325	
M261365	
M260825	
M260865	
M261625	
M261665	
M260925	
M260965	
M261725	
M261765	
M261025	
M261065	
M261125	
M261165	

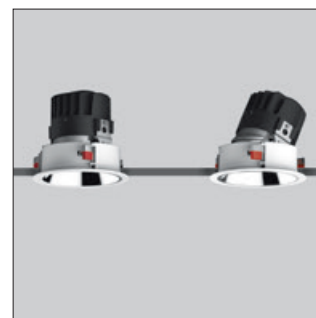

▼ IP20 / ▲ IP44 850° ø 136 mm

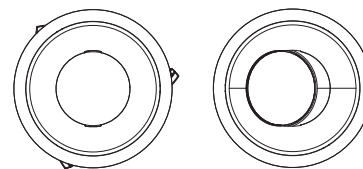
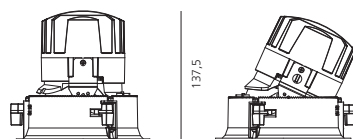

30°
360°

Driver 700mA SELV supplied separately.

Square						
W LED	Weight	Beam	Flux	CCT	Trim	Deflector
24,4 W	0,30 kg	18°	1860 lm	3000 K	○ ●	○ ●
					○ ●	○ ●
					○ ●	○ ●
					○ ●	○ ●
		1940 lm	4000 K	○ ●	○ ●	
				○ ●	○ ●	
				○ ●	○ ●	
				○ ●	○ ●	
		28°	1640 lm	3000 K	○ ●	○ ●
					○ ●	○ ●
					○ ●	○ ●
					○ ●	○ ●
1710 lm	4000 K	○ ●	○ ●			
		○ ●	○ ●			
		○ ●	○ ●			
		○ ●	○ ●			
46°	1520 lm	3000 K	○ ●	○ ●		
			○ ●	○ ●		
			○ ●	○ ●		
			○ ●	○ ●		
1590 lm	4000 K	○ ●	○ ●			
		○ ●	○ ●			
		○ ●	○ ●			
		○ ●	○ ●			

Fixed	
Code	
M263020	
M263060	
M263620	
M263660	
M263120	
M263160	
M263720	
M263760	
M263220	
M263260	
M264020	
M264060	
M263320	
M263360	
M264120	
M264160	
M263420	
M263460	
M263520	
M263560	

Adjustable	
Code	
M263025	
M263065	
M263625	
M263665	
M263125	
M263165	
M263725	
M263765	
M263225	
M263265	
M264025	
M264065	
M263325	
M263365	
M264125	
M264165	
M263425	
M263465	
M263525	
M263565	



▼ IP20 / ▲ IP44 850° 136 x 136 mm

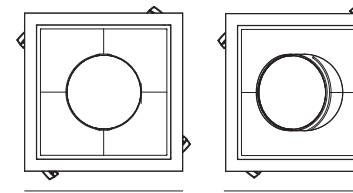
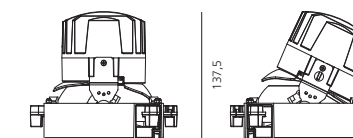

30°
4x90°

Driver 700mA SELV supplied separately.

Driver	Vac	L _{mm}	W _{mm}	H _{mm}		
cc 30W 700mA	220-240	165	43	30	1max	Non dimmable
cc 30W 700mA	220-240	144	32	32	1max	DALI dimmable

Code	
M076800	
M076900	

Everything 150 Kit trimless

Black ● Polished metal ○

Round optical unit: trimless

W LED	weight	Beam	Flux	CCT	Deflector
24,4 W	0,30 kg	18°	1860 lm	3000 K	●
			1940 lm	4000 K	○
		28°	1640 lm	3000 K	●
			1710 lm	4000 K	○
		46°	1520 lm	3000 K	●
			1590 lm	4000 K	●

Fixed

Code
M261800
M262400
M261900
M262500
M262000
M262600
M262100
M262700
M262200
M262300

Adjustable

Code
M261805
M262405
M261905
M262505
M262005
M262605
M262105
M262705
M262205
M262305



▼ IP20 / ▲ IP44 ⚡
850°

⤵
Ø 136 mm

Driver 700mA SELV supplied separately.

Fitting to be completed with installation frame for recessing into ceiling.

Frame

Round frame
for recessed installation

Code

M274800

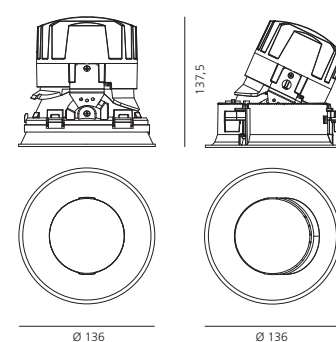

30°
360°

Square optical unit: trimless

W LED	weight	Beam	Flux	CCT	Deflector
24,4 W	0,30 kg	18°	1860 lm	3000 K	●
			1940 lm	4000 K	○
		28°	1640 lm	3000 K	●
			1710 lm	4000 K	○
		46°	1520 lm	3000 K	●
			1590 lm	4000 K	●

Fixed

Code
M264200
M264800
M264300
M264900
M264400
M265000
M264500
M265100
M264600
M264700

Adjustable

Code
M264205
M264805
M264305
M264905
M264405
M265005
M264505
M265105
M264605
M264705

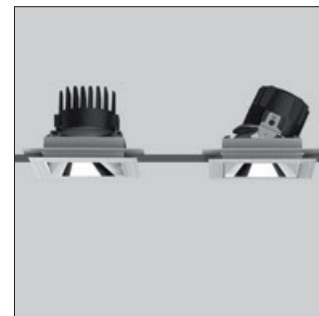

▼ IP20 / ▲ IP44 ⚡
850°

⊞
136 x 136 mm

Driver 700mA SELV supplied separately.

Fitting to be completed with installation frame for recessing into ceiling.

Frame

Square frame
for recessed installation

Code

M274900

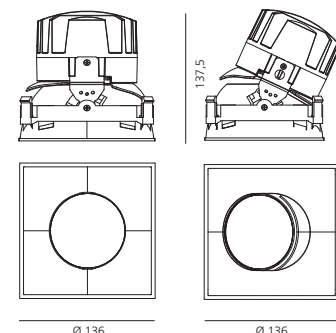
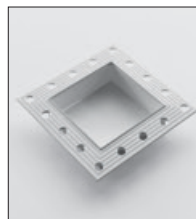

30°
4x90°

Driver	Vac	L _{mm}	W _{mm}	H _{mm}		Code
cc 30W 700mA	220-240	165	43	30	1max	Non dimmable M076800
cc 30W 700mA	220-240	144	32	32	1max	DALI dimmable M076900

Everything 150 Kit trim

Black ● Polished metal ●

Round optical unit: trimless					
W LED	weight	Beam	Flux	CCT	Deflector
24,4 W	0,30 kg	18°	1860 lm	3000 K	●
			1940 lm	4000 K	●
		28°	1640 lm	3000 K	●
			1710 lm	4000 K	●
		46°	1520 lm	3000 K	●
			1590 lm	4000 K	●

Fixed
Code
M261800
M262400
M261900
M262500
M262000
M262600
M262100
M262700
M262200
M262300

Adjustable
Code
M261805
M262405
M261905
M262505
M262005
M262605
M262105
M262705
M262205
M262305



▼ IP20 / ▲ IP44 ⚡
850°

⌚
ø 136 mm

Driver 700mA SELV supplied separately.

Fitting to be completed with installation frame for recessing into ceiling.

Frame	Color
Round frame for recessed installation	○
	●

Code
M286220
M286260

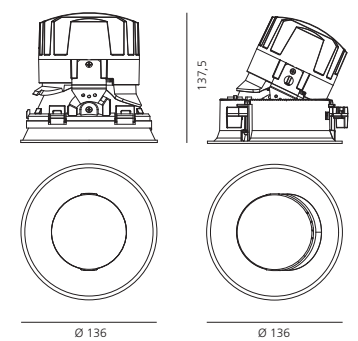

30°
360°

Square optical unit: trimless					
W LED	weight	Beam	Flux	CCT	Deflector
24,4 W	0,30 kg	18°	1860 lm	3000 K	●
			1940 lm	4000 K	●
		28°	1640 lm	3000 K	●
			1710 lm	4000 K	●
		46°	1520 lm	3000 K	●
			1590 lm	4000 K	●

Fixed
Code
M264200
M264800
M264300
M264900
M264400
M265000
M264500
M265100
M264600
M264700

Adjustable
Code
M264205
M264805
M264305
M264905
M264405
M265005
M264505
M265105
M264605
M264705

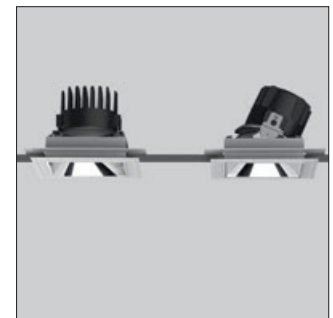

▼ IP20 / ▲ IP44 ⚡
850°

⌚
136 x 136 mm

Driver 700mA SELV supplied separately.

Fitting to be completed with installation frame for recessing into ceiling.

Frame	Color
Square frame for recessed installation	○
	●

Code
M286320
M286360

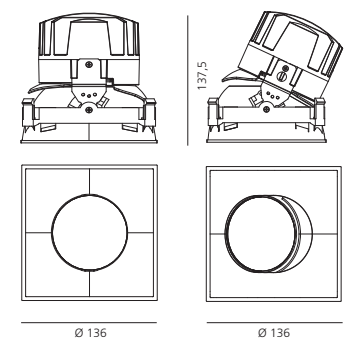
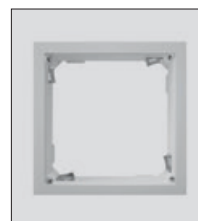

30°
4x90°

Driver	Vac	L _{mm}	W _{mm}	H _{mm}		
cc 30W 700mA	220-240	165	43	30	1max	Non dimmable
cc 30W 700mA	220-240	144	32	32	1max	DALI dimmable

Code
M076800
M076900

Everything 18°

LED	luminaire			
Power	24,4 W	24,4 W	24,4 W	24,4 W
Flux	2510 lm	2620 lm	1860 lm	1940 lm
CCT	3000 K	4000 K	3000 K	4000 K
CRI	=80 (min.)			
Color tolerance	MacAdam 3SDCM			
Service life	L70(6K) >50000h			
Beam			18°	18°
Efficiency			74%	74%
Efficacy	103 lm/W	107 lm/W	76 lm/W	79 lm/W

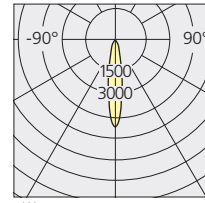
24,4 W 3000 K $\alpha=18^\circ$ 4000 K $\alpha=18^\circ$

H m	Ø m	E _{Max} lux	E _M lux	H m	Ø m	E _{Max} lux	E _M lux
1	0,32	9141	5634	1	0,32	9534	5876
2	0,65	2285	1408	2	0,65	2383	1469
3	0,97	1016	626	3	0,97	1059	653
4	1,30	571	352	4	1,30	596	367
5	1,62	366	225	5	1,62	381	235

Everything 28°

LED	luminaire			
Power	24,4 W	24,4 W	24,4 W	24,4 W
Flux	2510 lm	2620 lm	1640 lm	1710 lm
CCT	3000 K	4000 K	3000 K	4000 K
CRI	=80 (min.)			
Color tolerance	MacAdam 3SDCM			
Service life	L70(6K) >50000h			
Beam			28°	28°
Efficiency			65%	65%
Efficacy	103 lm/W	107 lm/W	67 lm/W	70 lm/W

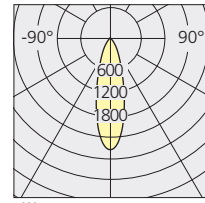
24,4 W 3000 K $\alpha=28^\circ$ 4000 K $\alpha=28^\circ$

H m	Ø m	E _{Max} lux	E _M lux	H m	Ø m	E _{Max} lux	E _M lux
1	0,51	4634	2843	1	0,51	4832	2965
2	1,02	1159	711	2	1,02	1208	741
3	1,53	515	316	3	1,53	537	329
4	2,03	290	178	4	2,03	320	185
5	2,54	185	114	5	2,54	193	119

Everything 46°

LED	luminaire			
Power	24,4 W	24,4 W	24,4 W	24,4 W
Flux	2510 lm	2620 lm	1520 lm	1590 lm
CCT	3000 K	4000 K	3000 K	4000 K
CRI	=80 (min.)			
Color tolerance	MacAdam 3SDCM			
Service life	L70(6K) >50000h			
Beam			46°	46°
Efficiency			61%	61%
Efficacy	103 lm/W	107 lm/W	62 lm/W	65 lm/W

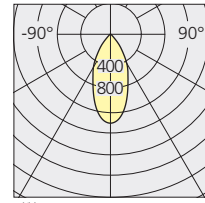
24,4 W 3000 K $\alpha=46^\circ$ 4000 K $\alpha=46^\circ$

H m	Ø m	E _{Max} lux	E _M lux	H m	Ø m	E _{Max} lux	E _M lux
1	0,85	2218	1233	1	0,85	2320	1290
2	1,70	554	308	2	1,70	580	322
3	2,56	246	137	3	2,56	258	143
4	3,41	139	77	4	3,41	145	81
5	4,26	89	49	5	4,26	93	52

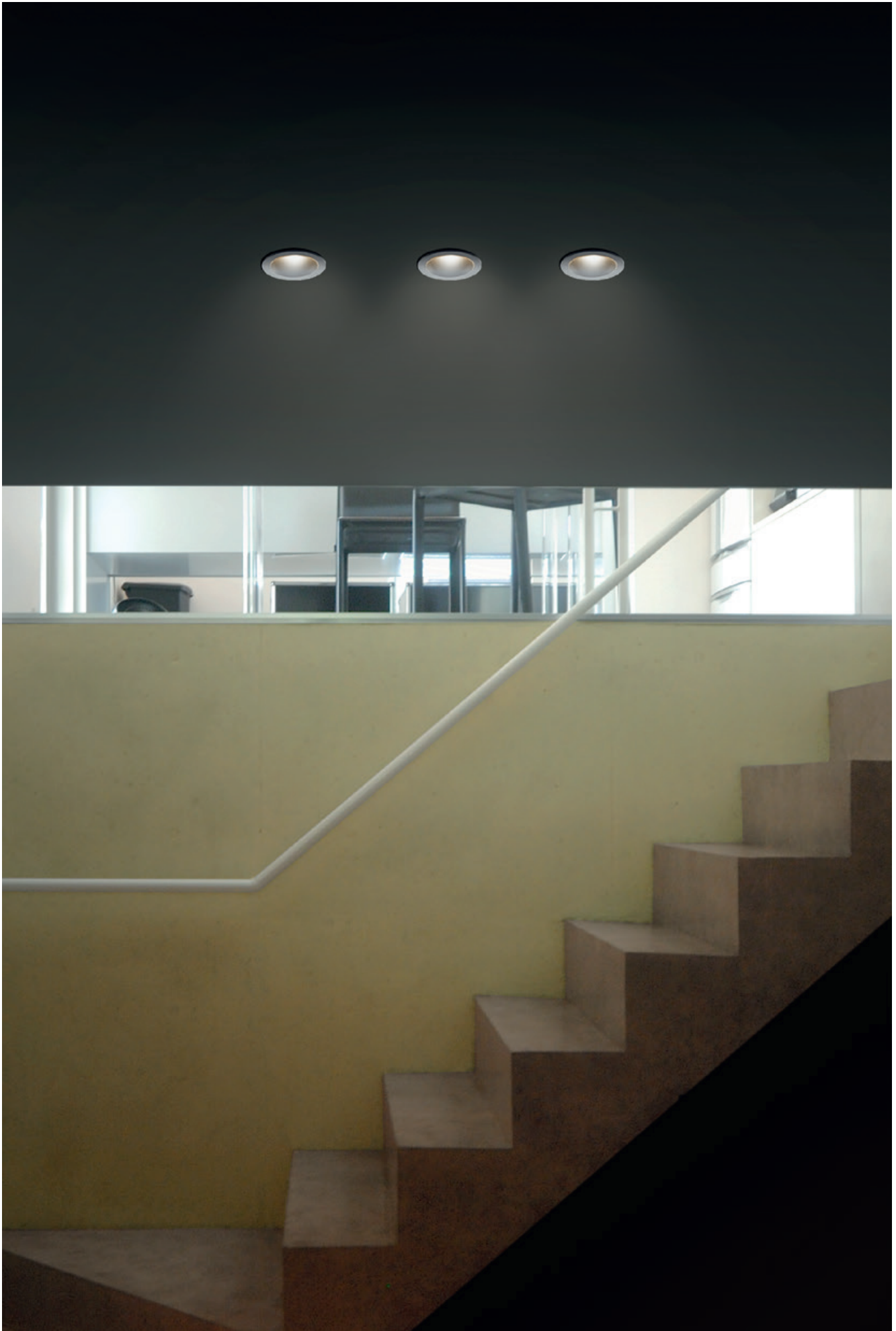

Luceri LED

Studio Artemide
2011 (Luceri LED)
2013 (Luceri Kadro LED)





Luceri LED and Kadro LED offer a modular range of professional, highly flexible downlighters, providing customisable lighting solutions for every need. Thanks to TrueWhite technology, colour temperature and colour rendering index are maintained constant throughout the lifespan of this product, guaranteeing a consistent, light quality. The emission of versions with metal reflector is compliant with EN12464 and has UGR<19, producing an effective and comfortable lighting solution.

Luceri LED



Luceri LED trim



- White frame
- Grey frame

- Recessed round fixed downlighters using high-output LEDs.
- Two versions: trim (with bezel) and Trimless (recessed ceiling mounted without bezel)
- Available in warm white (3000K) and neutral white (4000K)
- Available in 2 versions, each with 2 levels of power:
Standard version non dimmable, CRI=90 (min)
High-performance version with net efficiency up to 94lm/W, DALI dimmable, CRI=90 (min), with Cree True White (R) technology. Colour temperature and colour rendering index constant throughout the product lifespan.

- Standard version IP40.
- Materials: bezel, white reflector and screens in polycarbonate, reflectors in vacuum-metalled polycarbonate with anti-scratch surface treatment.
- IP54 with the addition of an optional screen.
- Compliant to standard EN60598-1, EN62471 and other specific standards.

Luceri LED trim

- Complete with optic housing and trim.
- Trim available in white or grey.
- Professional mirror optic with UGR Luminance Control <19 for office spaces with computer screens.
- Installation brackets for an easy, tool-free installation on false ceilings of thicknesses between 1 and 25 mm.
- Optional screens in transparent polycarbonate, easy to install, opal and prismoptic diffuser, with a 90 degree turn.
- Integral power supply.
- Wide beam symmetrical distribution.



Luceri LED trimless



Sharp edge trim



Rounded edge trim

Luceri LED trimless

- 2 available trims:
Sharp edge
Rounded edge
- 2 available optic housings.
- Professional mirror optic with UGR Luminance Control <19 for office spaces with computer screens.
- Comfort white optics
- Optics housings and trim to be ordered separately.
- Optional screens in transparent polycarbonate, easy to install, opal and prismoptic diffuser, with a 90 degree turn.
- Integral power supply
- Wide beam symmetrical distribution.

Banca di Caraglio - Credito Cooperativo Caraglio (CN) - Italy
Arch: Studio Kuadra, Photo: Federico Villa





Luceri LED trimless Rounded edge trim

LED comfort white optics

W	Weight	Beam	Flux	CCT
26 W	1,70 kg	66°	1974 lm	3000 K
			2112 lm	4000 K
29 W	1,70 kg	66°	2418 lm	3000 K
			2587 lm	4000 K

Lighting unit. To be completed with rounded edge trim support.

LED High-Performance comfort white optics

W	Weight	Beam	Flux	CCT
19 W	1,70 kg	66°	1711 lm	3000 K
				4000 K
26 W	1,70 kg	66°	2258 lm	3000 K
				4000 K

Lighting unit. To be completed with rounded edge trim support.
220/240Vac 50/60Hz electronic ballast included.

not dimmable

Code
M242400
M242500
M242600
M242700

Dali dimmable

Code
M242401
M242501
M242601
M242701



▼ IP20 / ▲ IP44
screenless.

▼ IP20 / ▲ IP54
with screen.



support with rounded edge trim

M240600

19 W / 26 W

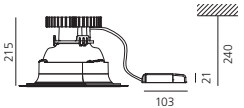

29 W

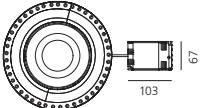
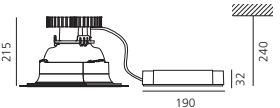

Frame (ext) Ø337
Frame (int) Ø211
Reflector (ext) Ø200

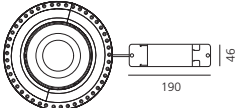

Frame (ext) Ø337
Frame (int) Ø211
Reflector (ext) Ø200

Luceri LED

LED	luminaire	
Power	22 W	26 W
Flux	2437 lm	1974 lm
CCT	3000 K	3000 K
CRI	=80 (min.)	
Color tolerance	MacAdam 3SDCM	
Service life	L70(6K) > 36000h	
Beam	66°	66°
Efficiency	81%	81%
Efficacy	111 lm/W	76 lm/W

26 W

3000 K α=66° 4000 K α=66°

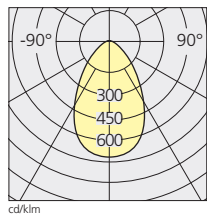

H m	Ø m	EMax lux	EM lux	H m	Ø m	EMax lux	EM lux
1	1,31	1404	694	1	1,31	1502	743
2	2,63	351	174	2	2,63	376	186
3	3,94	156	77	3	3,94	167	83
4	5,26	88	43	4	5,26	94	46
5	6,57	56	28	5	6,57	60	30

Luceri LED

LED	luminaire	
Power	25W	29 W
Flux	3022 lm	2418 lm
CCT	3000 K	3000 K
CRI	=80 (min.)	
Color tolerance	MacAdam 3SDCM	
Service life	L70(6K) > 36000h	
Beam	66°	66°
Efficiency	80%	80%
Efficacy	121 lm/W	83 lm/W

29 W

3000 K α=66° 4000 K α=66°

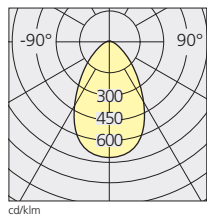

H m	Ø m	EMax lux	EM lux	H m	Ø m	EMax lux	EM lux
1	1,31	1720	850	1	1,31	1840	910
2	2,63	430	213	2	2,63	460	227
3	3,94	191	94	3	3,94	204	101
4	5,26	108	53	4	5,26	115	57
5	6,57	69	34	5	6,57	74	36

Luceri LED

High-Performance

LED	luminaire	
Power	16 W	19 W
Flux	2119 lm	1711 lm
CCT	3000 K-4000 K	
CRI	=90 (min.)	
Color tolerance	MacAdam 2SDCM	
Service life	L70(6K) > 36000h	
Beam	66°	
Efficiency	81%	
Efficacy	132 lm/W	90 lm/W

19 W

3000 K-4000 K α=66°

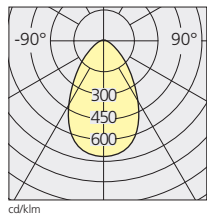

H m	Ø m	EMax lux	EM lux
1	1,31	1217	602
2	2,63	304	150
3	3,94	135	67
4	5,26	76	38
5	6,57	49	24

Luceri LED

High-Performance

LED	luminaire	
Power	22 W	26 W
Flux	2839 lm	2258 lm
CCT	3000 K-4000 K	
CRI	=90 (min.)	
Color tolerance	MacAdam 2SDCM	
Service life	L70(6K) > 36000h	
Beam	66°	
Efficiency	80%	
Efficacy	129 lm/W	87 lm/W

26 W

3000 K-4000 K α=66°

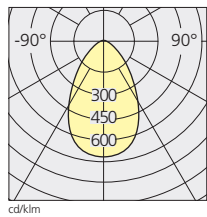

H m	Ø m	EMax lux	EM lux
1	1,31	1606	794
2	2,63	402	199
3	3,94	178	88
4	5,26	100	50
5	6,57	64	32



Accessories



Transparent screen
in polycarbonate

Code
M239200



Opal screen in PMMA

M239700



Prismoptic screen
in polycarbonate

M239600



With screen



Screenless

Luceri LED trimless Sharp edge trim

LED faceted mirror optics

W	Weight	Beam	Flux	CCT
26 W	1,60 kg	70°	1979 lm	3000 K
			2119 lm	4000 K
29 W	1,60 kg	70°	2507 lm	3000 K
			2682 lm	4000 K

Lighting unit. To be completed with sharp edge trim support.

LED High-Performance faceted mirror optics

W	Weight	Beam	Flux	CCT
19 W	1,60 kg	70°	1790 lm	3000 K
				4000 K
26 W	1,60 kg	70°	2336 lm	3000 K
				4000 K

Lighting unit. To be completed with sharp edge trim support.
220/240Vac 50/60Hz electronic ballast included.

not dimmable

Code
M242000
M242100
M242200
M242300

Dali dimmable

Code
M242001
M242101
M242201
M242301



▼ IP20 / ▲ IP44
screenless.

▼ IP20 / ▲ IP54
with screen.



∅216



Sharp edge trim

M240500



Accessory for ceiling installation

M239820

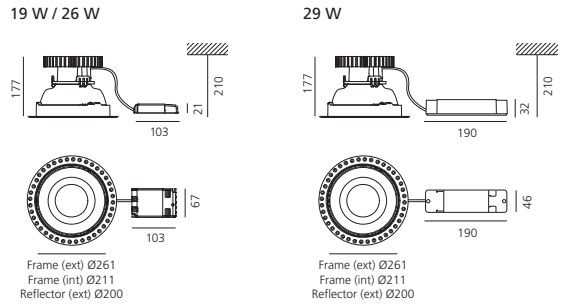

Luceri LED

LED	luminaire	
Power	22 W	26 W
Flux	2437 lm	1979 lm
CCT	3000 K	4000 K
CRI	=80 (min.)	
Color tolerance	MacAdam 3SDCM	
Service life	L70(6K) > 36000h	
Beam	70°	70°
Efficiency	81%	81%
Efficacy	111 lm/W	81 lm/W

26 W	3000 K	α=70°	4000 K	α=70°
	H m	∅ m	EMax lux	EM lux
	1	1,42	1473	831
	2	2,84	365	208
	3	4,26	162	92
	4	5,69	91	52
	5	7,11	58	33

Luceri LED

LED	luminaire	
Power	25W	29 W
Flux	3022 lm	2507 lm
CCT	3000 K	4000 K
CRI	=80 (min.)	
Color tolerance	MacAdam 3SDCM	
Service life	L70(6K) > 36000h	
Beam	70°	70°
Efficiency	83%	83%
Efficacy	121 lm/W	92 lm/W

29 W	3000 K	α=70°	4000 K	α=70°
	H m	∅ m	EMax lux	EM lux
	1	1,42	1840	1043
	2	2,84	460	261
	3	4,26	202	116
	4	5,69	113	65
	5	7,11	73	42

Luceri LED
High-Performance

LED	luminaire	
Power	16 W	19 W
Flux	2119 lm	1790 lm
CCT	3000 K-4000 K	3000 K-4000 K
CRI	=90 (min.)	
Color tolerance	MacAdam 2SDCM	
Service life	L70(6K) > 36000h	
Beam	70°	
Efficiency	84%	
Efficacy	132 lm/W	94 lm/W

19 W	3000 K-4000 K	α=70°
	H m	∅ m
	1	1,43
	2	2,85
	3	4,28
	4	5,71
	5	7,13

Luceri LED

LED	luminaire	
Power	22 W	26 W
Flux	2839 lm	2336 lm
CCT	3000 K-4000 K	3000 K-4000 K
CRI	=90 (min.)	
Color tolerance	MacAdam 2SDCM	
Service life	L70(6K) > 36000h	
Beam	70°	
Efficiency	82%	
Efficacy	129 lm/W	90 lm/W

26 W	3000 K-4000 K	α=70°
	H m	∅ m
	1	1,44
	2	2,87
	3	4,31
	4	5,75
	5	7,19

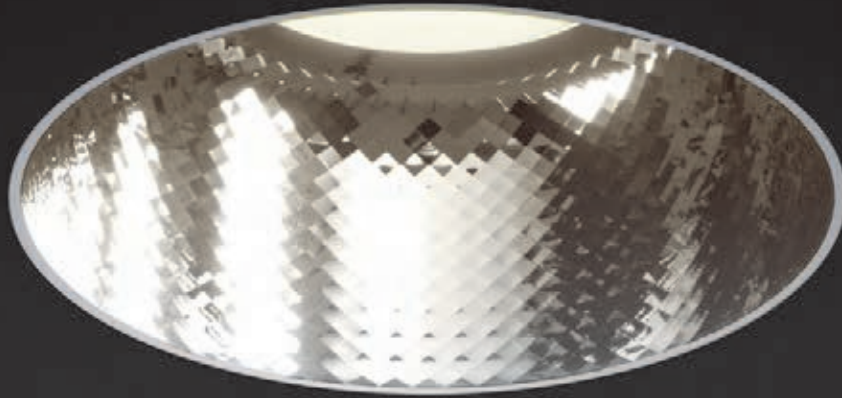

Accessories



Transparent screen
in polycarbonate

Code
M239200



Opal screen in PMMA

M239700



Prismatic screen
in polycarbonate

M239600



With screen



Screenless

Luceri LED trim

Gray ● White ○

LED faceted mirror optics

W	Weight	Beam	Flux	CCT	Color
26 W	1,50 kg	70°	1979 lm	3000 K	○
			2119 lm	4000 K	●
			2507 lm	3000 K	○
29 W	1,50 kg	70°	2507 lm	3000 K	○
			2682 lm	4000 K	●

Non dimmable

Code
M244020
M244060
M244120
M244160
M244220
M244260
M244320
M244360



▼ IP20 / ▲ IP44 screenless.

▼ IP20 / ▲ IP54 with screen.



∅230

LED High-Performance faceted mirror optics

W	Weight	Beam	Flux	CCT	Color
19 W	1,50 kg	70°	1790 lm	3000 K	○
				4000 K	●
26 W	1,50 kg	70°	2336 lm	3000 K	○
				4000 K	●

Dali dimmable

Code
M244021
M244061
M244121
M244161
M244221
M244261
M244321
M244361

19 W / 26 W

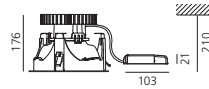

29 W

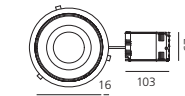
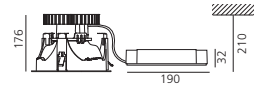

Frame (ext) Ø243
Frame (int) Ø211
Reflector (ext) Ø200

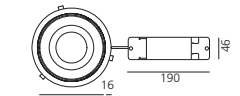

Frame (ext) Ø243
Frame (int) Ø211
Reflector (ext) Ø200

220/240Vac 50/60Hz electronic ballast included.

Luceri LED

LED	luminaire	
Power	22 W	26 W
Flux	2437 lm	1979 lm
CCT	3000 K	4000 K
CRI	=80 (min.)	
Color tolerance	MacAdam 3SDCM	
Service life	L70(6K) > 36000h	
Beam	70°	70°
Efficiency	81%	81%
Efficacy	111 lm/W	76 lm/W

26 W	3000 K	α=70°	4000 K	α=70°
	H	∅	EMax	EM
	m	m	lux	lux
	1	1,42	1473	831
	2	2,84	365	208
	3	4,26	162	92
	4	5,69	91	52
	5	7,11	58	33

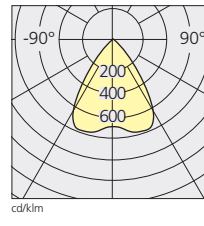

LED	luminaire	
Power	25W	29 W
Flux	3022 lm	2507 lm
CCT	3000 K	4000 K
CRI	=80 (min.)	
Color tolerance	MacAdam 3SDCM	
Service life	L70(6K) > 36000h	
Beam	70°	70°
Efficiency	83%	83%
Efficacy	121 lm/W	86 lm/W

29 W	3000 K	α=70°	4000 K	α=70°
	H	∅	EMax	EM
	m	m	lux	lux
	1	1,42	1840	1043
	2	2,84	460	261
	3	4,26	202	116
	4	5,69	113	65
	5	7,11	73	42

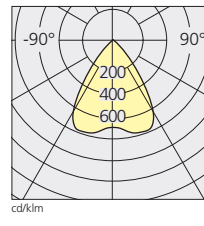

Luceri LED High-Performance

LED	luminaire	
Power	16 W	19 W
Flux	2119 lm	1790 lm
CCT	3000 K-4000 K	3000 K-4000 K
CRI	=90 (min.)	
Color tolerance	MacAdam 2SDCM	
Service life	L70(6K) > 36000h	
Beam	70°	70°
Efficiency	84%	84%
Efficacy	132 lm/W	94 lm/W

19 W	3000 K-4000 K	α=70°
	H	∅
	m	m
	1	1,43
	2	2,85
	3	4,28
	4	5,71
	5	7,13

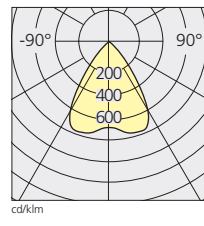

LED	luminaire	
Power	22 W	26 W
Flux	2839 lm	2336 lm
CCT	3000 K-4000 K	3000 K-4000 K
CRI	=90 (min.)	
Color tolerance	MacAdam 2SDCM	
Service life	L70(6K) > 36000h	
Beam	70°	70°
Efficiency	82%	82%
Efficacy	129 lm/W	90 lm/W

26 W	3000 K-4000 K	α=70°
	H	∅
	m	m
	1	1,44
	2	2,87
	3	4,31
	4	5,75
	5	7,19

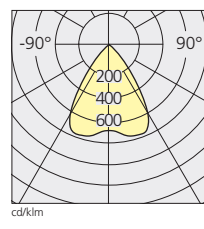

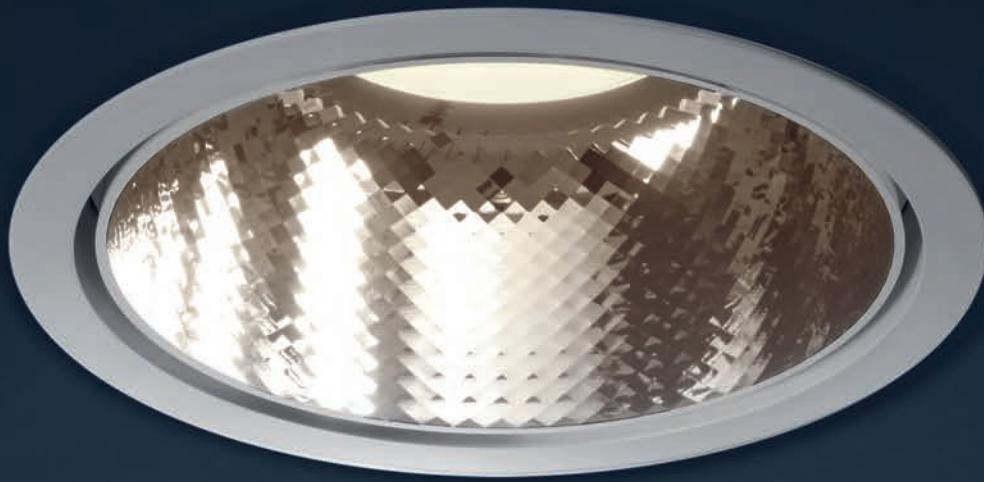

Accessories



Transparent screen
in polycarbonate

Code
M239200



Opal screen in PMMA

M239700



Prismoptic screen
in polycarbonate

M239600



With screen



Screenless

Luceri Kadro LED

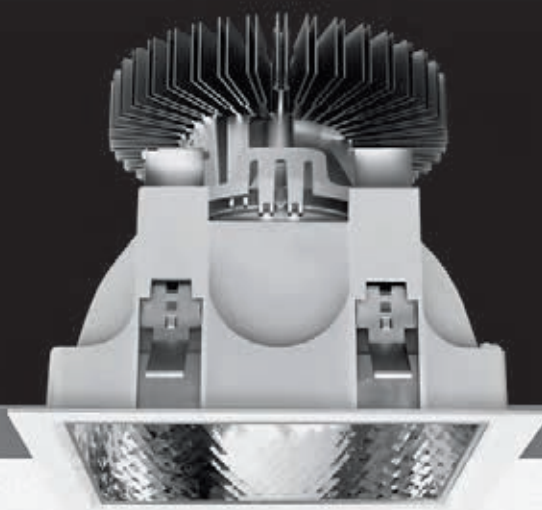

Luceri LED trim

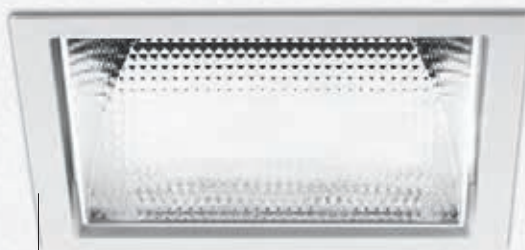

- White frame
- Grey frame

- Recessed square fixed downlighters using high-output LEDs.
- Two versions: trim (with bezel) and Trimless (recessed ceiling mounted without bezel)
- Available in warm white (3000K) and neutral white (4000K)
- Available in 2 versions, each with 2 levels of power:
Standard version non dimmable, CRI=90 (min)
High-performance version with net efficiency up to 94lm/W, DALI dimmable, CRI=90 (min), with Cree True White (R) technology. Colour temperature and colour rendering index constant throughout the product lifespan.

- Standard version IP40.
- Materials: bezel, white reflector and screens in polycarbonate, reflectors in vacuum-metalled polycarbonate with anti-scratch surface treatment.
- IP54 with the addition of an optional screen.
- Compliant to standard EN60598-1, EN62471 and other specific standards.

Luceri Kadro LED trim

- Complete with optic housing and trim.
- Trim available in white or grey.
- Professional mirror optic with UGR Luminance Control <19 for office spaces with computer screens.
- Installation brackets for an easy, tool-free installation on false ceilings of thicknesses between 1 and 25 mm.
- Optional screens in transparent polycarbonate, easy to install opal and prismoptic diffuser, with a 90 degree turn.
- Integral power supply.
- Wide beam symmetrical distribution.

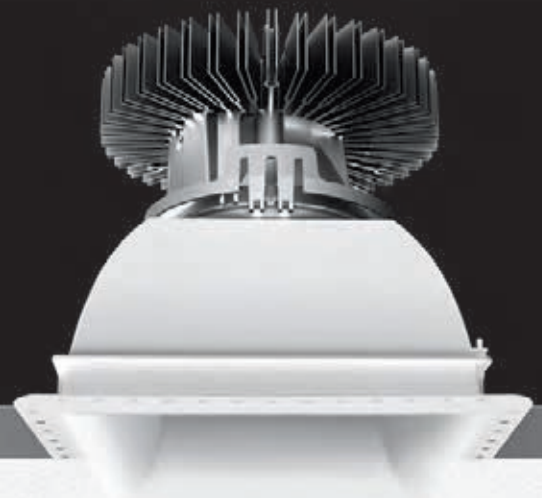

Luceri LED trimless

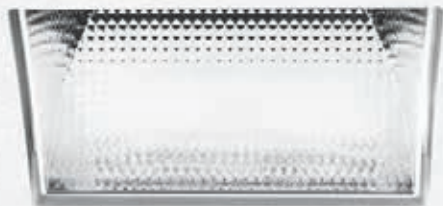

Sharp edge trim



Rounded edge trim

Luceri Kadro LED trimless

- 2 available trims:
Sharp edge
Rounded edge
- 2 available optic housings:
- Professional mirror optic with UGR Luminance Control <19 for office spaces with computer screens.
- Comfort white optics
- Optics housings and trim to be ordered separately.
- Optional screens in transparent polycarbonate, easy to install opal and prismoptic diffuser, with a 90 degree turn.
- Integral power supply
- Wide beam symmetrical distribution.

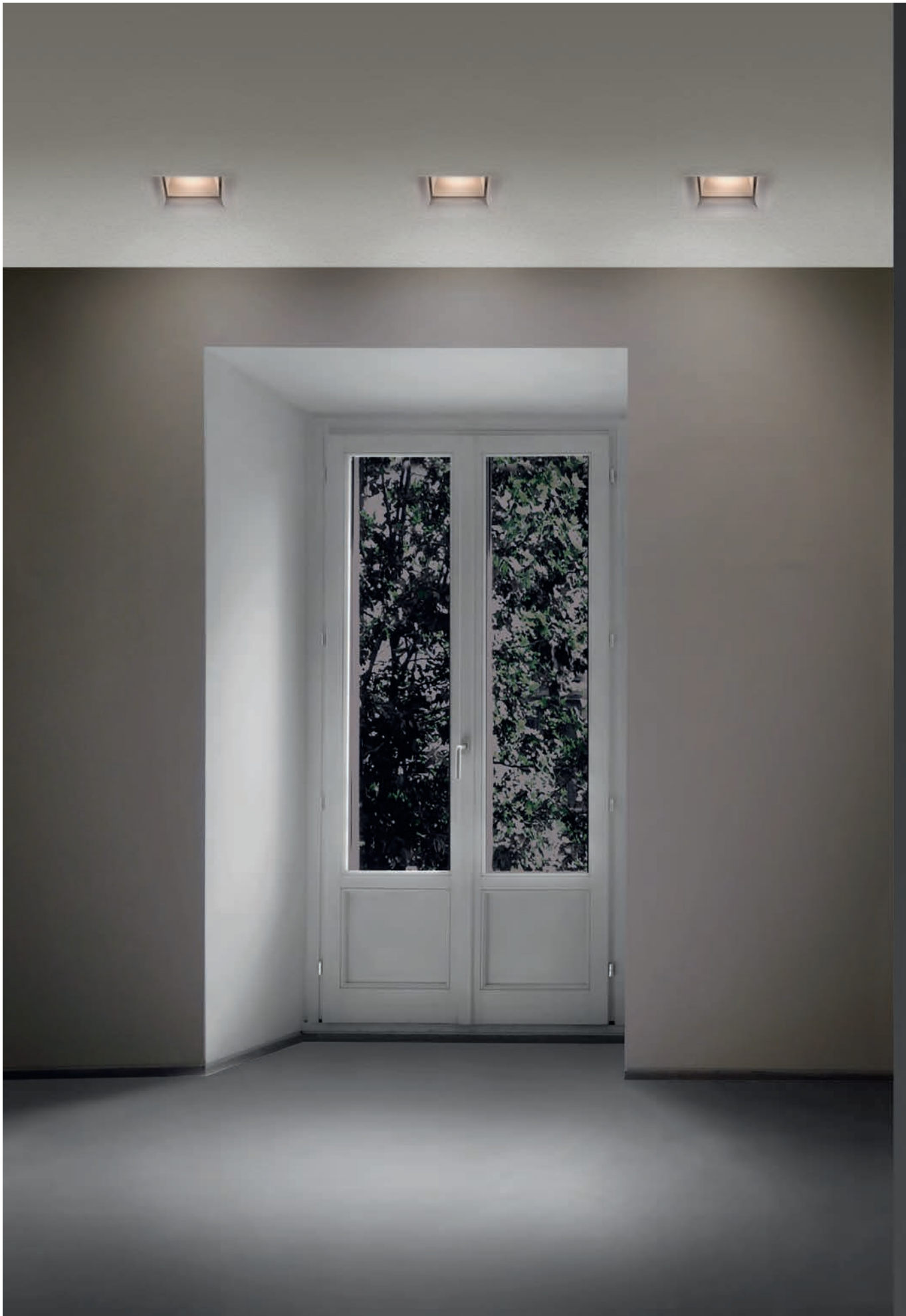





Accessories



Transparent screen
in polycarbonate

Code
M239300



Opal screen in PMMA

M239400



Prismoptic screen
in polycarbonate

M239500



With screen



Screenless

Luceri Kadro LED trimless Sharp edge trim

LED faceted mirror optics

W	Weight	Beam	Flux	CCT
26 W	1,50 kg	54°	1954 lm	3000 K
			2091 lm	4000 K
29 W	1,50 kg	54°	2424 lm	3000 K
			2594 lm	4000 K

Lighting unit. To be completed with sharp edge trim support.

LED High-Performance faceted optics

W	Weight	Beam	Flux	CCT
19 W	1,50 kg	60°	1765 lm	3000 K
				4000 K
26 W	1,50 kg	60°	2282 lm	3000 K
				4000 K

Lighting unit. To be completed with sharp edge trim support.
220/240Vac 50/60Hz electronic ballast included.

non dimmable

Code
M241000
M241100
M241200
M241300

Dali dimmable

Code
M241001
M241101
M241201
M241301



▼ IP20 / ▲ IP44
screenless.

▼ IP20 / ▲ IP54
with screen.



195x195 mm

Sharp edge trim M240700

Accessory for ceiling installation M239920

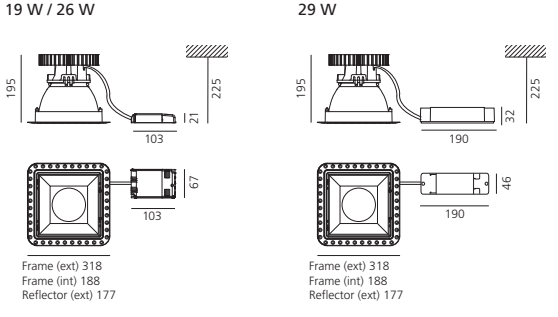

Luceri Kadro LED	LED		luminaire	
Power	22 W	22 W	26 W	26 W
Flux	2437 lm	2608 lm	1954 lm	2091 lm
CCT	3000 K	4000 K	3000 K	4000 K
CRI	=80 (min.)			
Color tolerance	MacAdam 3SDCM			
Service life	L70(6K) > 36000h			
Beam			54°	54°
Efficiency			80%	80%
Efficacy	111 lm/W	118 lm/W	75 lm/W	80 lm/W

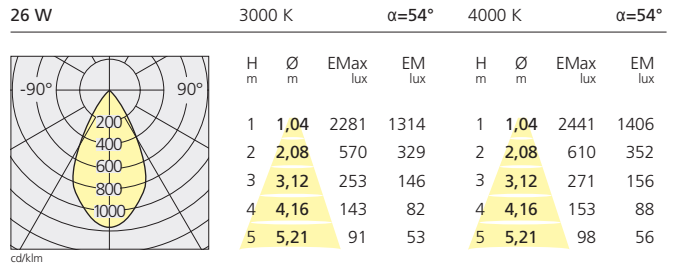

Luceri Kadro LED	LED		luminaire	
Power	25W	25W	29 W	29 W
Flux	3022 lm	3233 lm	2424 lm	2594 lm
CCT	3000 K	4000 K	3000 K	4000 K
CRI	=80 (min.)			
Color tolerance	MacAdam 3SDCM			
Service life	L70(6K) > 36000h			
Beam			54°	54°
Efficiency			80%	80%
Efficacy	121 lm/W	129 lm/W	84 lm/W	89 lm/W

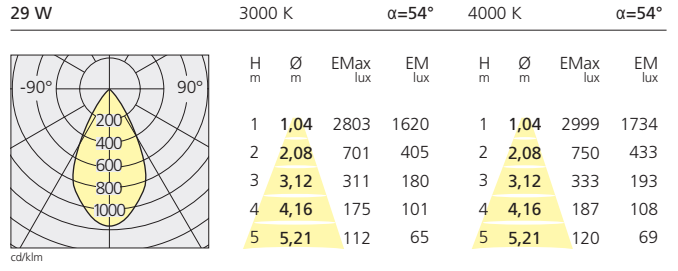

Luceri Kadro LED High-Performance	LED		luminaire	
Power	16 W		19 W	
Flux	2119 lm		1765 lm	
CCT	3000 K-4000 K		3000 K-4000 K	
CRI	=90 (min.)			
Color tolerance	MacAdam 2SDCM			
Service life	L70(6K) > 36000h			
Beam			60°	
Efficiency			83%	
Efficacy	132 lm/W		93 lm/W	

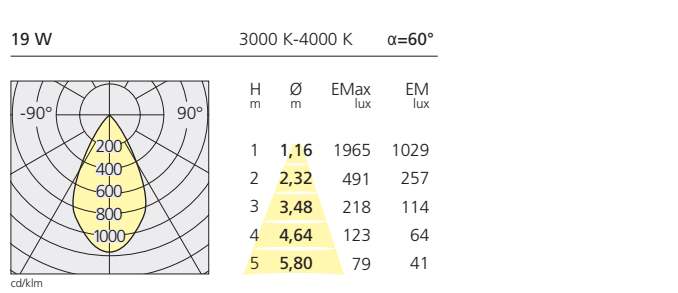

Luceri Kadro LED High-Performance	LED		luminaire	
Power	22 W		26 W	
Flux	2839 lm		2282 lm	
CCT	3000 K-4000 K		3000 K-4000 K	
CRI	=90 (min.)			
Color tolerance	MacAdam 2SDCM			
Service life	L70(6K) > 36000h			
Beam			60°	
Efficiency			80%	
Efficacy	129 lm/W		88 lm/W	

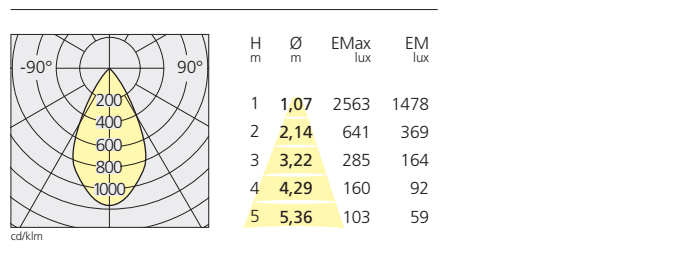



Accessories



Transparent screen
in polycarbonate

Code
M239300



Opal screen in PMMA

M239400



Prismoptic screen
in polycarbonate

M239500

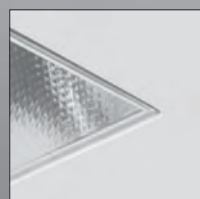

With screen

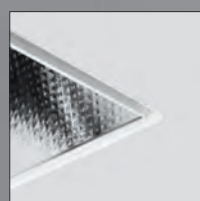

Screenless

Luceri Kadro LED con trim

Gray White

LED faceted mirror optics

W	Weight	Beam	Flux	CCT	Color	Code
26 W	1,60 kg	54°	1954 lm	3000 K	<input type="radio"/>	M243220
				4000 K	<input type="radio"/>	M243260
			2091 lm	3000 K	<input type="radio"/>	M243320
				4000 K	<input type="radio"/>	M243360
29 W	1,60 kg	54°	2424 lm	3000 K	<input type="radio"/>	M243420
				4000 K	<input type="radio"/>	M243460
			2594 lm	3000 K	<input type="radio"/>	M243520
				4000 K	<input type="radio"/>	M243560

not dimmable



▼ IP20 / ▲ IP44 screenless.

▼ IP20 / ▲ IP54 with screen.



203x203mm

LED High-Performance faceted mirror optics

W	Weight	Beam	Flux	CCT	Color	Code
19 W	1,60 kg	60°	1765 lm	3000 K	<input type="radio"/>	M243221
				4000 K	<input type="radio"/>	M243261
			2282 lm	3000 K	<input type="radio"/>	M243321
				4000 K	<input type="radio"/>	M243361
26 W	1,60 kg	60°	2282 lm	3000 K	<input type="radio"/>	M243421
				4000 K	<input type="radio"/>	M243461
			2282 lm	3000 K	<input type="radio"/>	M243521
				4000 K	<input type="radio"/>	M243561

Dali dimmable

19 W / 26 W

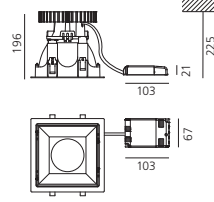

Frame (ext) 218
Frame (int) 188
Reflector (ext) 177

29 W

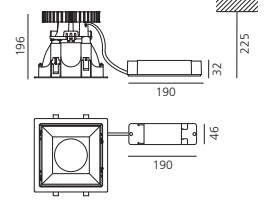

Frame (ext) 218
Frame (int) 188
Reflector (ext) 177

220/240Vac 50/60Hz electronic ballast included.

Luceri Kadro LED

LED luminaire

	22 W	26 W
Power	22 W	26 W
Flux	2437 lm	2091 lm
CCT	3000 K	4000 K
CRI	=80 (min.)	
Color tolerance	MacAdam 3SDCM	
Service life	L70(6K) > 36000h	
Beam	54°	54°
Efficiency	80%	80%
Efficacy	111 lm/W	80 lm/W

26 W 3000 K α=54° 4000 K α=54°

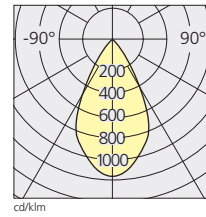

H m	Ø m	EMax lux	EM lux
1	1,04	2281	1314
2	2,08	570	329
3	3,12	253	146
4	4,16	143	82
5	5,21	91	53

LED luminaire

	25 W	29 W
Power	25 W	29 W
Flux	3022 lm	2594 lm
CCT	3000 K	4000 K
CRI	=80 (min.)	
Color tolerance	MacAdam 3SDCM	
Service life	L70(6K) > 36000h	
Beam	54°	54°
Efficiency	80%	80%
Efficacy	121 lm/W	89 lm/W

29 W 3000 K α=54° 4000 K α=54°

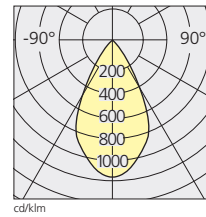

H m	Ø m	EMax lux	EM lux
1	1,04	2803	1620
2	2,08	701	405
3	3,12	311	180
4	4,16	175	101
5	5,21	112	65

Luceri Kadro LED High-Performance

LED luminaire

	16 W	19 W
Power	16 W	19 W
Flux	2119 lm	1765 lm
CCT	3000 K-4000 K	3000 K-4000 K
CRI	=90 (min.)	
Color tolerance	MacAdam 2SDCM	
Service life	L70(6K) > 36000h	
Beam	60°	60°
Efficiency	83%	83%
Efficacy	132 lm/W	93 lm/W

19 W 3000 K-4000 K α=60°

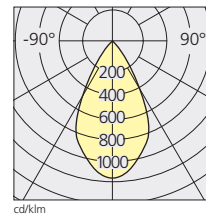

H m	Ø m	EMax lux	EM lux
1	1,16	1965	1029
2	2,32	491	257
3	3,48	218	114
4	4,64	123	64
5	5,80	79	41

LED luminaire

	22 W	26 W
Power	22 W	26 W
Flux	2839 lm	2282 lm
CCT	3000 K-4000 K	3000 K-4000 K
CRI	=90 (min.)	
Color tolerance	MacAdam 2SDCM	
Service life	L70(6K) > 36000h	
Beam	60°	60°
Efficiency	80%	80%
Efficacy	129 lm/W	88 lm/W

26 W 3000 K-4000 K α=60°

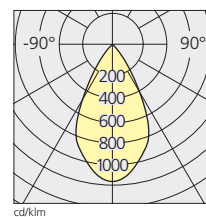

H m	Ø m	EMax lux	EM lux
1	1,07	2563	1478
2	2,14	641	369
3	3,22	285	164
4	4,29	160	92
5	5,36	103	59



Accessories



Transparent screen
in polycarbonate

Code
M239300



Opal screen in PMMA

M239400



Prismoptic screen
in polycarbonate

M239500



With screen



Screenless

Luceri Fluo

Studio Artemide
1998



- A range of recessed downlights fluorescent lamps.
- Body made from technopolymers. Reflector in vacuum-metallised polycarbonate with anti-scratch surface treatment.
- Decorative ring made from aluminium or injection moulded plastic, available in 2 colour options, with or without screen. Fitting is made by one quarter turn rotation.
- The Luceri screen dark light optic ensures a controlled luminance level of less than 200 cd/m² for an observation angle of 65° or above with respect to the vertical axis, well within the limits set by standard EN12464-1.
- Low recess depth for ceilings of 1mm to 35mm thick.
- Electronic ballast and emergency lighting.
- Electrical connection by means of quick connectors.
- Bridging connection possible.
- Complies with standard EN60598-1 and other specific standards.







Luceri Fluo

White Grey

TC-DEL (G24q-2/3)

Non dimmable

+ emergency 1h

W	Weight	Beam	Flux	Color	Code	Code
2x18W (G24q-2)	1,00/1,70 kg	106°	2400 lm	<input type="radio"/>	L596610	L596810
				<input type="radio"/>	L596620	L596820
2x26W (G24q-3)	1,00/1,70 kg	106°	3600 lm	<input type="radio"/>	L596710	L596910
				<input type="radio"/>	L596720	L596920

Supplied with plastic front and frosted glass.
220/240Vac 50/60Hz electronic ballast included.



▼ IP29 / ▲ IP23 850°

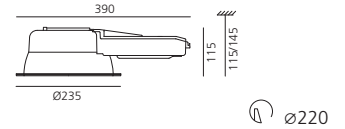

TC-DEL 2x18W/2400lm Efficiency 39% α=106°

TC-DEL 2x26W/3600lm Efficiency 25% α=106°

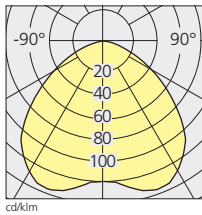

H m	Ø m	EMax lux	EM lux
1	2,65	291	37
2	5,31	73	9
3	7,96	32	4
4	10,62	18	2
5	13,27	12	1

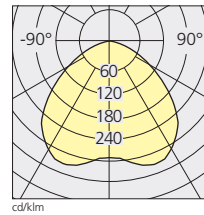

H m	Ø m	EMax lux	EM lux
1	2,65	302	37
2	5,31	76	9
3	7,96	34	4
4	10,62	19	2
5	13,27	12	1

TC-DEL (G24q-2/3)

Non dimmable

+ emergency 1h

W	Weight	Beam	Flux	Color	Code	Code
2x18W (G24q-2)	1,00/1,70 kg	96°	2400 lm	<input type="radio"/>	L596650	L596850
				<input type="radio"/>	L596660	L596860
2x26W (G24q-3)	1,00/1,70 kg	96°	3600 lm	<input type="radio"/>	L596750	L596950
				<input type="radio"/>	L596760	L596960

Supplied with plastic front and anti-dazzle, cross-blade louvre.
220/240Vac 50/60Hz electronic ballast included.



▼ IP29 / ▲ IP23 850°

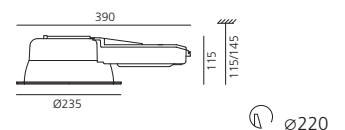

TC-DEL 2x18W/2400lm Efficiency 50% α=96°

TC-DEL 2x26W/3600lm Efficiency 47% α=96°

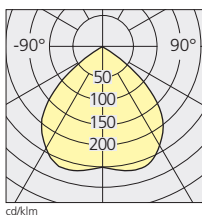

H m	Ø m	EMax lux	EM lux
1	2,20	575	93
2	4,40	144	23
3	6,59	64	10
4	8,79	36	6
5	10,99	23	4

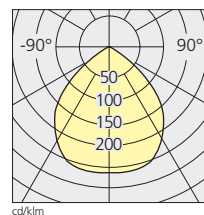

H m	Ø m	EMax lux	EM lux
1	2,20	908	154
2	4,40	227	39
3	6,59	101	17
4	8,79	57	10
5	10,99	36	6

Luceri Fluo

White Grey

TC-DEL (G24q-2/3)

W	Weight	Beam	Flux	Color
2x18W (G24q-2)	0,90/1,60 kg	90°	2400 lm	<input type="radio"/>
2x26W (G24q-3)	0,90/1,60 kg	90°	3600 lm	<input type="radio"/>

Non dimmable

Code
L597610
L597620
L597710
L597720

+ emergency 1h

Code
L597810
L597820
L597910
L597920

Supplied with plastic front and frosted glass.
220/240Vac 50/60Hz electronic ballast included.



▼ IP29 / ▲ IP23 □ 850°

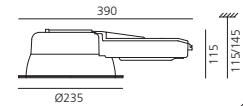

⌀220

TC-DEL 2x18W/2400lm Efficiency 43% α=90°

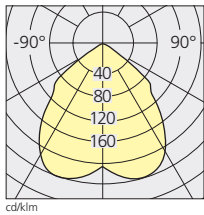

H m	Ø m	EMax lux	EM lux
1	1,97	471	98
2	3,93	118	25
3	5,90	52	11
4	7,86	29	6
5	9,83	19	4

TC-DEL 2x26W/3600lm Efficiency 46% α=90°

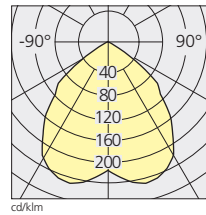

H m	Ø m	EMax lux	EM lux
1	2,03	751	148
2	4,06	188	37
3	6,08	83	16
4	8,11	47	9
5	10,14	30	6







- Light fixture with high-performance LED light sources.
- Ceiling installation.
- Consists of: frame, body, lens, fixing springs.
- Frame in injection mould of aluminium.
- Heat sink body in extruded aluminium.
- Lens in polycarbonate with 3 different versions of beam.
- Fixing springs in harmonic steel.
- White monochromatic LEDs available in 3 colour temperatures:
Very Warm = 2700K
Warm = 3000K
Neutral = 4000K
- Electrical connection to the driver by means of a FEP-FEP cable and a terminal board.
- IP Rating IP40.
- Insulation class III.
- Technical features of light fixtures in compliance with EN60598-1.
- Installation must be carried out by specialized personnel.
- Carefully follow the instructions.

Parabola

Medium flood



Flood



Wide flood



Medium flood



Flood

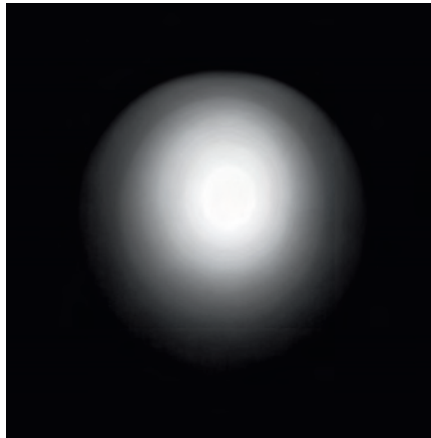

Wide flood



Remote ballast supplied separately.

Heats sink in aluminium with black anodization.

Fixing springs in harmonic steel.

Frame in injection mould of aluminium with polycarbonate lens.





Parabola 55

White ○ Black ● Silver ●

Round

W	LED Weight	Beam	Flux	CCT	Color
3 W	0,15 kg	30°	221 lm	3000 K	○
				4000 K	●
			232 lm	3000 K	○
				4000 K	●
		58°	225 lm	3000 K	○
				4000 K	●
			235 lm	3000 K	○
				4000 K	●

Fixed

Code
NL1906840K006
NL1906840K004
NL1906840K002
NL1906840W006
NL1906840W004
NL1906840W002
NL1906860K006
NL1906860K004
NL1906860K002
NL1906860W006
NL1906860W004
NL1906860W002

Adjustable

Code
NL1907040K006
NL1907040K004
NL1907040K002
NL1907040W006
NL1907040W004
NL1907040W002
NL1907060K006
NL1907060K004
NL1907060K002
NL1907060W006
NL1907060W004
NL1907060W002



IP40

ø 52±2

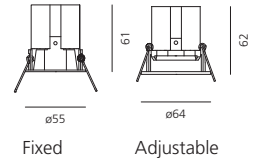

Driver 350 mA SELV supplied separately.

Square

W	LED Weight	Beam	Flux	CCT	Color
3 W	0,15 kg	30°	221 lm	3000 K	○
				4000 K	●
			232 lm	3000 K	○
				4000 K	●
		58°	225 lm	3000 K	○
				4000 K	●
			235 lm	3000 K	○
				4000 K	●

Fixed

Code
NL1906940K006
NL1906940K004
NL1906940K002
NL1906940W006
NL1906940W004
NL1906940W002
NL1906960K006
NL1906960K004
NL1906960K002
NL1906960W006
NL1906960W004
NL1906960W002



IP40

52 x 45 ±2

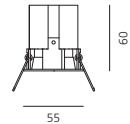

Driver 350 mA SELV supplied separately.

Driver	Vac	L _{mm}	W _{mm}	H _{mm}	n°device	Code	
cc 15W 350mA	220-240	103	34	19	1 max	Non dimmable	M077700
cc 35W 350mA	220-240	103	67	21	1 max	PUSH/1-10V dimmable	NL62810
cc 16W 350mA	220-240	125	79	22	1 max	DAU/PUSH/0-10V dimmable	M077401

Parabola 55	30°	LED	luminaire	3 W	3000 K	α=30°	4000 K	α=30°
Power	3 W	3 W	3 W	3 W				
Flux	345 lm	361 lm	221 lm	232 lm				
CCT	3000 K	4000 K	3000 K	4000 K				
CRI	=80 (min.)							
Color tolerance	MacAdam 3SDCM							
Service life	L70(9K) > 54000h							
Beam			30°	30°				
Efficiency			64%	64%				
Efficacy	111 lm/W	116 lm/W	71 lm/W	75 lm/W				

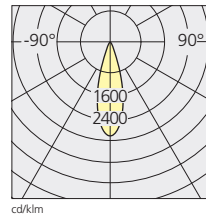

Parabola 55	58°	LED	luminaire	3 W	3000 K	α=58°	4000 K	α=58°
Power	3 W	3 W	3 W	3 W				
Flux	345 lm	361 lm	225 lm	235 lm				
CCT	3000 K	4000 K	3000 K	4000 K				
CRI	=80 (min.)							
Color tolerance	MacAdam 3SDCM							
Service life	L70(9K) > 54000h							
Beam			58°	58°				
Efficiency			65%	65%				
Efficacy	111 lm/W	116 lm/W	72 lm/W	76 lm/W				

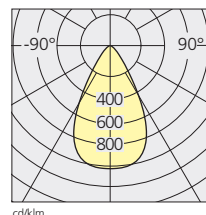

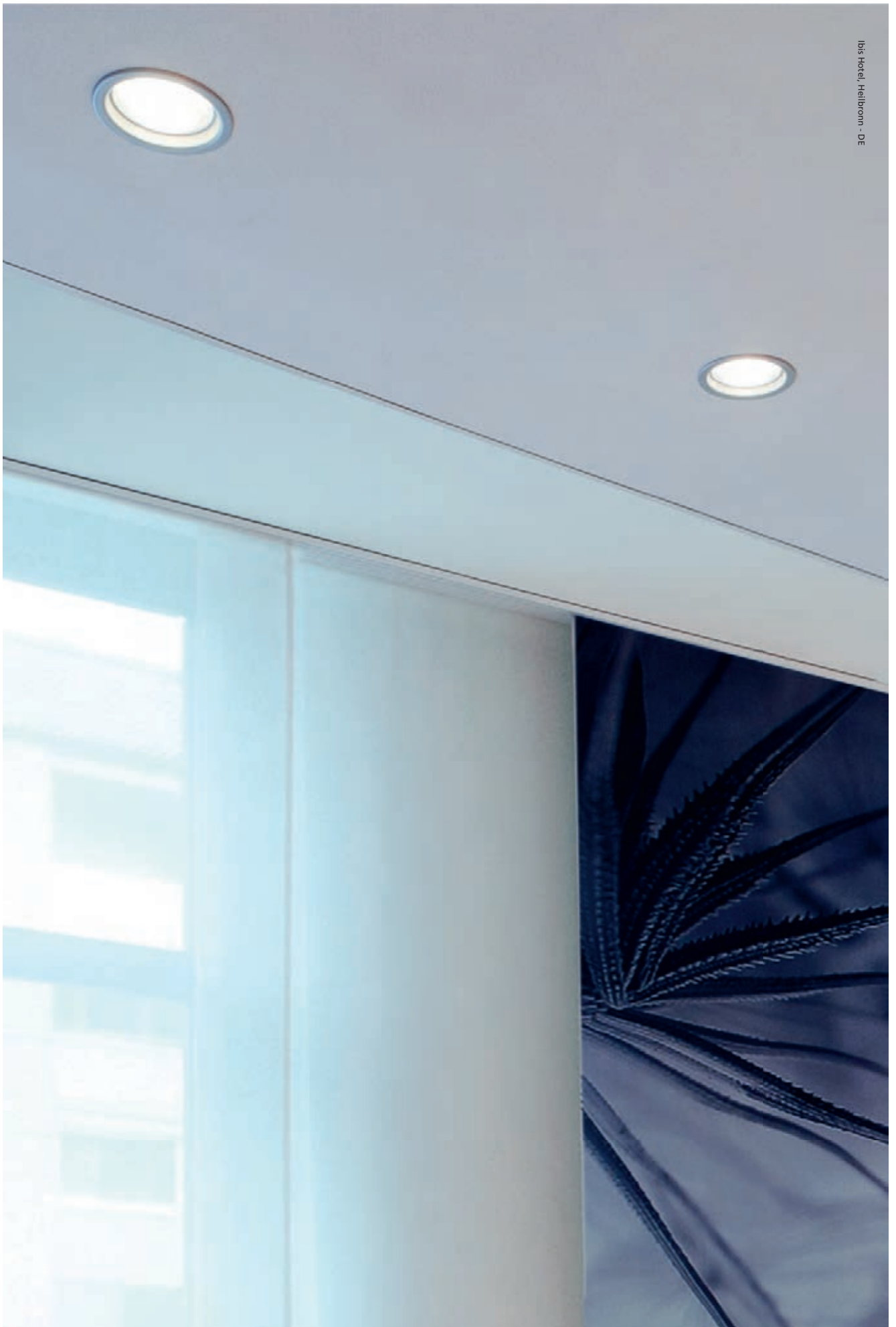

Parabola 80

White ○ Black ● Silver ●

Round

W LED	Weight	Beam	Flux	CCT	Color		
12 W	0,28 kg	52°	749 lm	2700 K	○		
					●		
					●		
					1011 lm	3000 K	○
							●
							●
					1053 lm	4000 K	○
							●
							●
				64°	745 lm	2700 K	○
							●
							●
			1006 lm	3000 K	○		
					●		
					●		
			1047 lm	4000 K	○		
					●		
					●		
		76°	773 lm	2700 K	○		
					●		
					●		
			1043 lm	3000 K	○		
					●		
					●		
			1086 lm	4000 K	○		
					●		
					●		

Fixed

Code
NL1906340Y006
NL1906340Y004
NL1906340Y002
NL1906340K006
NL1906340K004
NL1906340K002
NL1906340W006
NL1906340W004
NL1906340W002
NL1906360Y006
NL1906360Y004
NL1906360Y002
NL1906360K006
NL1906360K004
NL1906360K002
NL1906360W006
NL1906360W004
NL1906360W002
NL1906380Y006
NL1906380Y004
NL1906380Y002
NL1906380K006
NL1906380K004
NL1906380K002
NL1906380W006
NL1906380W004
NL1906380W002

Adjustable

Code
NL1906440Y006
NL1906440Y004
NL1906440Y002
NL1906440K006
NL1906440K004
NL1906440K002
NL1906440W006
NL1906440W004
NL1906440W002
NL1906460Y006
NL1906460Y004
NL1906460Y002
NL1906460K006
NL1906460K004
NL1906460K002
NL1906460W006
NL1906460W004
NL1906460W002
NL1906480Y006
NL1906480Y004
NL1906480Y002
NL1906480K006
NL1906480K004
NL1906480K002
NL1906480W006
NL1906480W004
NL1906480W002



IP40

∅ 68±2

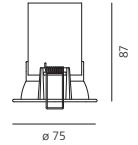

IP40

∅ 78±2

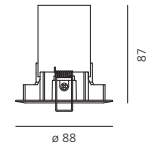

Driver 350 mA SELV supplied separately.

Square

W LED	Weight	Beam	Flux	CCT	Color		
12 W	0,28 kg	52°	749 lm	2700 K	○		
					●		
					●		
					1011 lm	3000 K	○
							●
							●
					1053 lm	4000 K	○
							●
							●
				64°	745 lm	2700 K	○
							●
							●
			1006 lm	3000 K	○		
					●		
					●		
			1047 lm	4000 K	○		
					●		
					●		
		76°	773 lm	2700 K	○		
					●		
					●		
			1043 lm	3000 K	○		
					●		
					●		
			1086 lm	4000 K	○		
					●		
					●		

Fixed

Code
NL1907140Y006
NL1907140Y004
NL1907140Y002
NL1907140K006
NL1907140K004
NL1907140K002
NL1907140W006
NL1907140W004
NL1907140W002
NL1907160Y006
NL1907160Y004
NL1907160Y002
NL1907160K006
NL1907160K004
NL1907160K002
NL1907160W006
NL1907160W004
NL1907160W002
NL1907180Y006
NL1907180Y004
NL1907180Y002
NL1907180K006
NL1907180K004
NL1907180K002
NL1907180W006
NL1907180W004
NL1907180W002

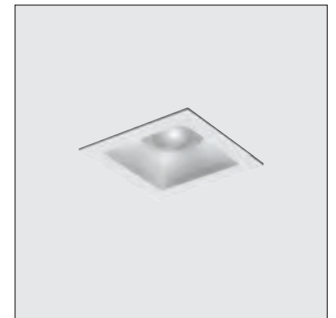

IP40

65 x 62 ±2

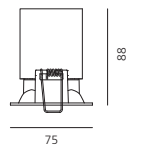

Driver 350 mA SELV supplied separately.

Driver	Vac	L _{mm}	W _{mm}	H _{mm}	n°device	Code
cc 15W 350mA	220-240	156	52	26	1 max	Non dimmable
cv 15W 350mA	220-240	103	67	21	1 max	PUSH/1-10V dimmable
cv 16W 350mA	220-240	125	79	22	1 max	DALI/PUSH/0-10V dimmable

Code
M077500
NL62810
M077401

Parabola 80	52°	LED	luminaire					
Power		12 W	12 W					
Flux		990 lm	1336 lm	1391 lm	749 lm	1011 lm	1053 lm	
CCT		2700 K	3000 K	4000 K	2700 K	3000 K	4000 K	
CRI		=90 (min.) =80 (min.) =80 (min.)						
Color tolerance		MacAdam 3SDCM						
Service life		L70(9K) > 54000h						
Beam					52°	52°	52°	
Efficiency					76%	76%	76%	
Efficacy		82 lm/W	111 lm/W	116 lm/W	63 lm/W	84 lm/W	88 lm/W	

12 W 2700 K α=52° 3000 K α=52° 4000 K α=52°

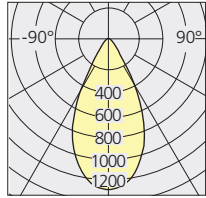

H	Ø	EMax	EM	H	Ø	EMax	EM	H	Ø	EMax	EM
1	0,96	996	553	1	0,96	1345	747	1	0,96	1401	778
2	1,92	249	138	2	1,92	336	187	2	1,92	350	194
3	2,87	111	61	3	2,87	149	83	3	2,87	156	86
4	3,83	62	35	4	3,83	84	47	4	3,83	88	49
5	4,79	40	22	5	4,79	54	30	5	4,79	546	31

Parabola 80	64°	LED	luminaire					
Power		12 W	12 W					
Flux		990 lm	1336 lm	1391 lm	745 lm	1006 lm	1047 lm	
CCT		2700 K	3000 K	4000 K	2700 K	3000 K	4000 K	
CRI		=90 (min.) =80 (min.) =80 (min.)						
Color tolerance		MacAdam 3SDCM						
Service life		L70(9K) > 54000h						
Beam					64°	64°	64°	
Efficiency					75%	75%	75%	
Efficacy		82 lm/W	111 lm/W	116 lm/W	62 lm/W	84 lm/W	87 lm/W	

12 W 2700 K α=64° 3000 K α=64° 4000 K α=64°

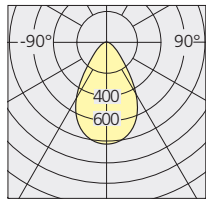

H	Ø	EMax	EM	H	Ø	EMax	EM	H	Ø	EMax	EM
1	1,25	612	312	1	1,25	827	422	1	1,25	861	439
2	2,50	153	78	2	2,50	207	105	2	2,50	215	110
3	3,76	68	35	3	3,76	92	47	3	3,76	96	49
4	5,01	38	20	4	5,01	52	26	4	5,01	54	27
5	6,26	24	12	5	6,26	33	17	5	6,26	34	18

Parabola 80	76°	LED	luminaire					
Power		12 W	12 W					
Flux		990 lm	1336 lm	1391 lm	773 lm	1043 lm	1086 lm	
CCT		2700 K	3000 K	4000 K	2700 K	3000 K	4000 K	
CRI		=90 (min.) =80 (min.) =80 (min.)						
Color tolerance		MacAdam 3SDCM						
Service life		L70(9K) > 54000h						
Beam					76°	76°	76°	
Efficiency					78%	78%	78%	
Efficacy		82 lm/W	111 lm/W	116 lm/W	64 lm/W	87 lm/W	90 lm/W	

12 W 2700 K α=76° 3000 K α=76° 4000 K α=76°

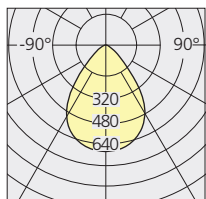

H	Ø	EMax	EM	H	Ø	EMax	EM	H	Ø	EMax	EM
1	1,55	526	243	1	1,55	710	327	1	1,55	739	341
2	3,10	132	61	2	3,10	178	82	2	3,10	185	85
3	4,66	58	27	3	4,66	79	36	3	4,66	82	38
4	6,21	33	15	4	6,21	44	20	4	6,21	46	21
5	7,76	21	10	5	7,76	28	13	5	7,76	30	14

Parabola 100

White ○ Black ● Silver ●

Round

W LED	Weight	Beam	Flux	CCT	Color	
17 W	0,50 kg	50°	959 lm	2700 K	○	
					●	
					●	
				1407 lm	3000 K	○
						●
						●
				1471 lm	4000 K	○
						●
						●
		64°		942 lm	2700 K	○
						●
						●
1382 lm	3000 K			○		
				●		
				●		
1445 lm	4000 K	○				
		●				
		●				
76°		948 lm	2700 K	○		
				●		
				●		
		1392 lm	3000 K	○		
				●		
				●		
1455 lm	4000 K	○				
		●				
		●				

Fixed

Code
NL1907240Y006
NL1907240Y004
NL1907240Y002
NL1907240K006
NL1907240K004
NL1907240K002
NL1907240W006
NL1907240W004
NL1907240W002
NL1907260Y006
NL1907260Y004
NL1907260Y002
NL1907260K006
NL1907260K004
NL1907260K002
NL1907260W006
NL1907260W004
NL1907260W002
NL1907280Y006
NL1907280Y004
NL1907280Y002
NL1907280K006
NL1907280K004
NL1907280K002
NL1907280W006
NL1907280W004
NL1907280W002

Adjustable

Code
NL1907440Y006
NL1907440Y004
NL1907440Y002
NL1907440K006
NL1907440K004
NL1907440K002
NL1907440W006
NL1907440W004
NL1907440W002
NL1907460Y006
NL1907460Y004
NL1907460Y002
NL1907460K006
NL1907460K004
NL1907460K002
NL1907460W006
NL1907460W004
NL1907460W002
NL1907480Y006
NL1907480Y004
NL1907480Y002
NL1907480K006
NL1907480K004
NL1907480K002
NL1907480W006
NL1907480W004
NL1907480W002



IP40 $\varnothing 85 \pm 2$

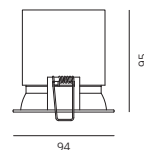

IP40 $\varnothing 95 \pm 2$

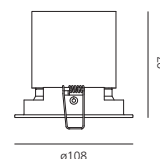

Driver 500 mA SELV supplied separately.

Square

W LED	Weight	Beam	Flux	CCT	Color	
17 W	0,50 kg	50°	959 lm	2700 K	○	
					●	
					●	
				1407 lm	3000 K	○
						●
						●
				1471 lm	4000 K	○
						●
						●
		64°		942 lm	2700 K	○
						●
						●
1382 lm	3000 K			○		
				●		
				●		
1445 lm	4000 K	○				
		●				
		●				
76°		948 lm	2700 K	○		
				●		
				●		
		1392 lm	3000 K	○		
				●		
				●		
1455 lm	4000 K	○				
		●				
		●				

Fixed

Code
NL1907340Y006
NL1907340Y004
NL1907340Y002
NL1907340K006
NL1907340K004
NL1907340K002
NL1907340W006
NL1907340W004
NL1907340W002
NL1907360Y006
NL1907360Y004
NL1907360Y002
NL1907360K006
NL1907360K004
NL1907360K002
NL1907360W006
NL1907360W004
NL1907360W002
NL1907380Y006
NL1907380Y004
NL1907380Y002
NL1907380K006
NL1907380K004
NL1907380K002
NL1907380W006
NL1907380W004
NL1907380W002



IP40 81 x 78 ±2

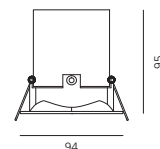

Driver 500 mA SELV supplied separately.

Driver	Vac	L _{mm}	W _{mm}	H _{mm}	n°device	Code
cc 20W 500mA	220-240	125	38	23	1 max	Non dimmable
cv 24W 500mA	220-240	103	67	21	1 max	PUSH/0-10V dimmable
cv 24W 500mA	220-240	103	67	21	1 max	DAU Dimmable

Code
M077600
M079300
M079200

Parabola 100	50°	LED luminaire					
Power	17 W		17 W				
Flux	1290 lm	1896 lm	1982 lm	959 lm	1407 lm	1471 lm	
CCT	2700 K	3000 K	4000 K	2700 K	3000 K	4000 K	
CRI	=90 (min.) =80 (min.) =80 (min.)						
Color tolerance	MacAdam 3SDCM						
Service life	L70(9K) > 54000h						
Beam			50°	50°	50°		
Efficiency			74%	74%	74%		
Efficacy	74 lm/W	110 lm/W	114 lm/W	55 lm/W	82 lm/W	85 lm/W	

17 W 2700 K α=50° 3000 K α=50° 4000 K α=50°

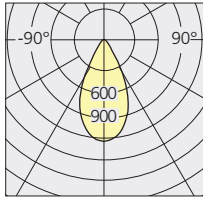

	H m	Ø m	E _{Max} lux	E _M lux	H m	Ø m	E _{Max} lux	E _M lux	H m	Ø m	E _{Max} lux	E _M lux
1	1	0,94	1169	655	1	0,94	1716	961	1	0,94	1794	1005
2	2	1,88	292	164	2	1,88	429	240	2	1,88	448	251
3	3	2,81	130	73	3	2,81	191	107	3	2,81	199	112
4	4	3,75	73	41	4	3,75	107	60	4	3,75	112	63
5	5	4,69	47	26	5	4,69	69	38	5	4,69	72	40

Parabola 100	64°	LED luminaire					
Power	17 W		17 W				
Flux	1290 lm	1896 lm	1982 lm	942 lm	1382 lm	1445 lm	
CCT	2700 K	3000 K	4000 K	2700 K	3000 K	4000 K	
CRI	=90 (min.) =80 (min.) =80 (min.)						
Color tolerance	MacAdam 3SDCM						
Service life	L70(9K) > 54000h						
Beam			64°	64°	64°		
Efficiency			73%	73%	73%		
Efficacy	74 lm/W	110 lm/W	114 lm/W	54 lm/W	80 lm/W	83 lm/W	

17 W 2700 K α=64° 3000 K α=64° 4000 K α=64°

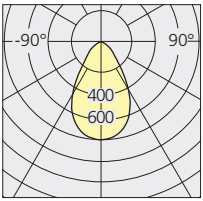

	H m	Ø m	E _{Max} lux	E _M lux	H m	Ø m	E _{Max} lux	E _M lux	H m	Ø m	E _{Max} lux	E _M lux
1	1	1,24	754	387	1	1,24	1106	568	1	1,24	1157	594
2	2	2,47	188	97	2	2,47	277	142	2	2,47	289	148
3	3	3,71	84	43	3	3,71	123	63	3	3,71	129	66
4	4	4,95	47	24	4	4,95	69	35	4	4,95	72	37
5	5	6,18	30	15	5	6,18	44	23	5	6,18	46	24

Parabola 100	76°	LED luminaire					
Power	17 W		17 W				
Flux	1290 lm	1896 lm	1982 lm	948 lm	1392 lm	1455 lm	
CCT	2700 K	3000 K	4000 K	2700 K	3000 K	4000 K	
CRI	=90 (min.) =80 (min.) =80 (min.)						
Color tolerance	MacAdam 3SDCM						
Service life	L70(9K) > 54000h						
Beam			76°	76°	76°		
Efficiency			73%	73%	73%		
Efficacy	74 lm/W	110 lm/W	114 lm/W	54 lm/W	81 lm/W	84 lm/W	

17 W 2700 K α=76° 3000 K α=76° 4000 K α=76°

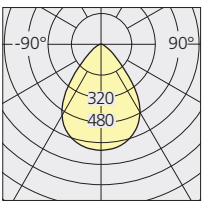

	H m	Ø m	E _{Max} lux	E _M lux	H m	Ø m	E _{Max} lux	E _M lux	H m	Ø m	E _{Max} lux	E _M lux
1	1	1,55	624	288	1	1,55	916	423	1	1,55	957	442
2	2	3,10	156	72	2	3,10	229	106	2	3,10	239	110
3	3	4,65	69	32	3	4,65	102	47	3	4,65	106	49
4	4	6,20	39	18	4	6,20	57	26	4	6,20	60	28
5	5	7,75	25	12	5	7,75	37	17	5	7,75	38	18

Parabola

175- 230

Michele De Lucchi
Massimo Sacconi
2010



- Light fixture with high-performance LED light sources.
- Ceiling installation.
- Consists of: frame, body, lens, fixing springs.
- Frame in lathed aluminium.
- Spun sheet aluminium reflector, metallized with 99.99% pure aluminium vacuum deposition.
- Black anodised extruded aluminium heatsink.
- Injection-moulded PMMA lens.
- Adjustable aluminium mounting brackets for 10-20 mm-thick false ceilings.
- Includes power unit.
- White monochromatic LEDs available in 2 colour temperatures:
Warm = 3000K
Neutral = 4000K
- IP Rating IP40.
- Insulation class I.
- Technical features of light fixtures in compliance with EN60598-1.
- Installation must be carried out by specialised personnel.
- Carefully follow the instructions.



Parabola 175-230

White Silver Polished metal

Parabola 175

W LED	Weight	Flux	CCT	Driver
20 W	2 kg	1577 lm	3000 K	
		1662 lm	4000 K	
		1577 lm	3000 K	1-10V
		1662 lm	4000 K	1-10V
		1577 lm	3000 K	DALI
		1662 lm	4000 K	DALI

Code
NL17212VTK0
NL17212VTW0
NL17213VTK0
NL17213VTW0
NL17214VTK0
NL17214VTW0



IP40

Ø 180±2

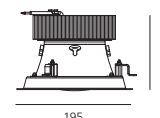

220/240Vac 50/60Hz electronic ballast included.

Parabola 230

W LED	Weight	Flux	CCT	Driver
28 W	3 kg	1853 lm	3000 K	
		1935 lm	4000 K	
		1853 lm	3000 K	1-10V
		1935 lm	4000 K	1-10V
		1853 lm	3000 K	DALI
		1935 lm	4000 K	DALI

Code
NL17215VTK0
NL17215VTW0
NL17216VTK0
NL17216VTW0
NL17217VTK0
NL17217VTW0





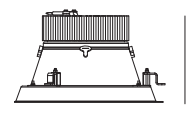

IP40

Ø 235±2

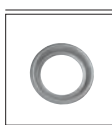
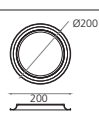

220/240Vac 50/60Hz electronic ballast included.

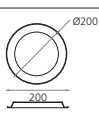
Accessories

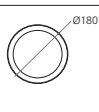
	Frame curved light		<input type="radio"/> silver <input type="radio"/> white
	Frame sharp light		<input type="radio"/> silver <input type="radio"/> white
	Chrome ring		<input checked="" type="radio"/> Polished metal

Parabola 175

Code
NL7044002
NL7044006

Parabola 230

Code
NL7147002
NL7147006

NL7043002
NL7043006

NL7146002
NL7146006

NL31008

NL31009

Parabola 175

LED	luminaire	
Power	17 W	20 W
Flux	1971 lm	2077 lm
CCT	3000 K	4000 K
CRI	=80 (min.)	
Color tolerance	MacAdam 3SDCM	
Service life	L70(9K) > 53000h	
Beam	64°	64°
Efficiency	80%	80%
Efficacy	96 lm/W	122 lm/W

20 W	α=64°		3000 K	α=64°		4000 K	α=64°	
	H m	Ø m	EMax lux	EM lux	H m	Ø m	EMax lux	EM lux
	1	1,25	1221	751	1	1,25	1287	792
	2	2,50	305	188	2	2,50	322	198
	3	3,75	136	83	3	3,75	143	88
	4	4,99	76	47	4	4,99	80	49
	5	6,24	49	30	5	6,24	51	32

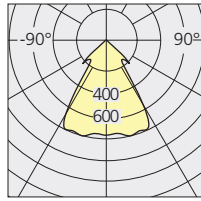

Parabola 230

LED	luminaire	
Power	26 W	28 W
Flux	2538 lm	2651 lm
CCT	3000 K	4000 K
CRI	=80 (min.)	
Color tolerance	MacAdam 3SDCM	
Service life	L70(9K) > 53000h	
Beam	64°	64°
Efficiency	73%	73%
Efficacy	98 lm/W	122 lm/W

20 W	α=64°		3000 K	α=64°		4000 K	α=64°	
	H m	Ø m	EMax lux	EM lux	H m	Ø m	EMax lux	EM lux
	1	1,25	1435	882	1	1,25	1499	922
	2	2,50	359	221	2	2,50	375	230
	3	3,75	159	98	3	3,75	167	102
	4	4,99	90	55	4	4,99	94	58
	5	6,24	57	35	5	6,24	60	37

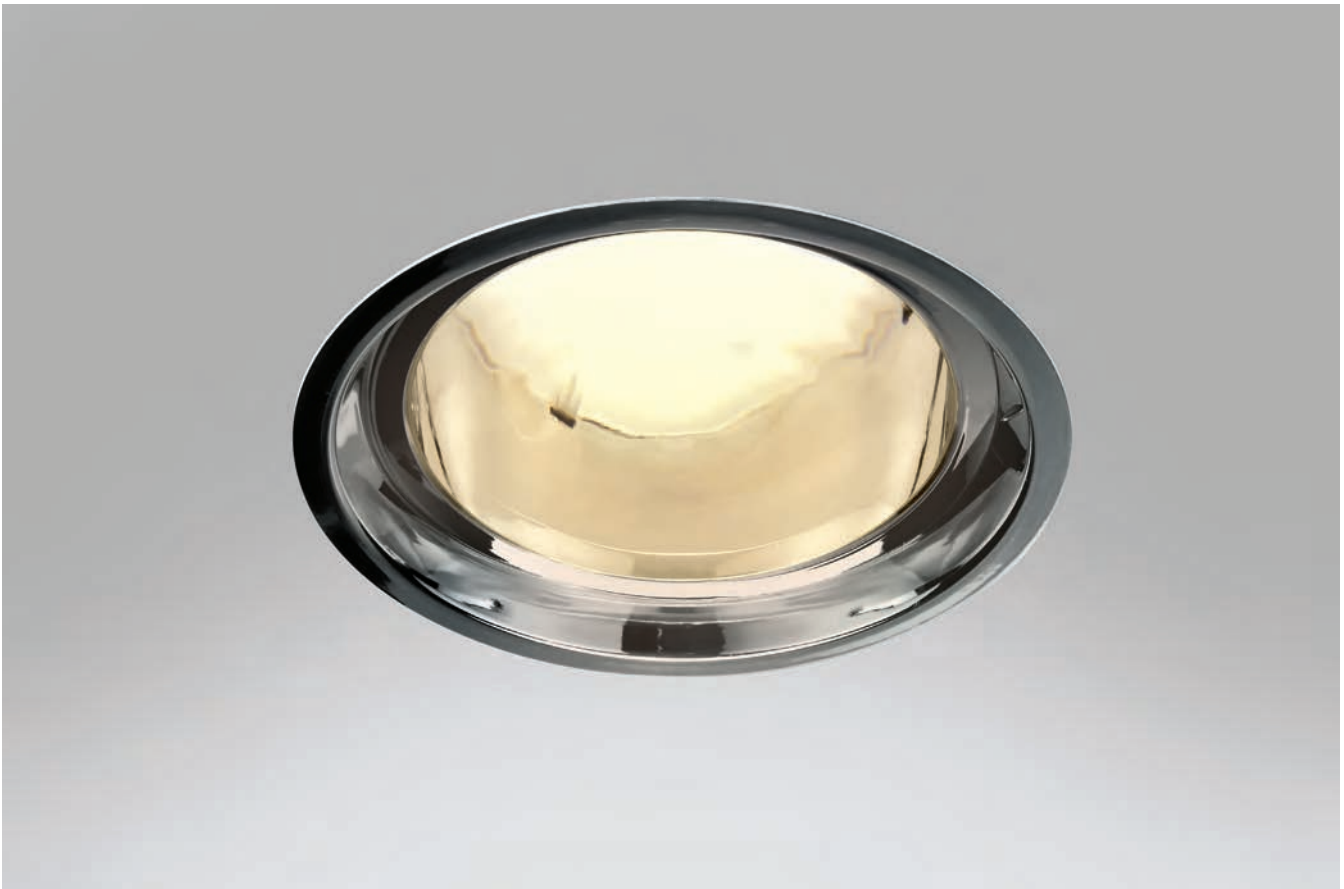
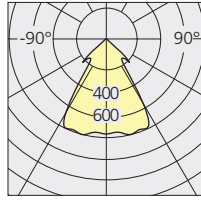



Rastaf LED

- Series of LED recessed luminaires, round or square.
- Fixed and adjustable versions available.
- No accessories needed in the IP44 fixed version (IP44 from below)
- Tilt angle up to 45°.
- White steel recessing plate available separately, for 2 or 3 downlighters.
- Range of recessing accessories available.
- Separate power supply.
- Compliant with EN60598-1 standard and other specific standards.

Rastaf

- A range of fixed and adjustable, recessed downlights, using 12 V dichroic halogen lamps, HIPAR51 metal-halide and 230-240 V LEDs.
- Steel body, available in 5 colour options.
- 2 size options: ø86mm and ø125mm.
- Tilt angle of up to 45°, rotation of up to 355° depending on the version.
- Version IP44 comes with integral safety cover and sealed glass.
- Optional steel recessing ring with white finish for use with 2 or 3 downlights ø86mm.
- Wide range of accessories for recessing into false ceilings, allowing lamp replacement without damaging the surface.
- Remote transformer.
- Complies with standard EN60598-1 and other specific standards.



Rastaf 86 LED round

White
○

						Fixed optic	Adjustable optic
W (LED)	Weight	Beam	Flux	CCT	Color	Code	Code
12,4 W	0,65 kg	20°	355 lm	3000 K	○	M038500	M038505
			375 lm	4000 K	○	M038800	M038805
		32°	285 lm	3000 K	○	M038700	M038705
			300 lm	4000 K	○	M039000	M039005

Driver 350 mA SELV supplied separately.



▼ IP20 / ▲ IP44 ⌀ ⌀72 mm

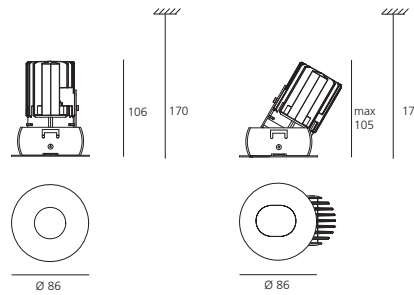

IP20 ⌀ ⌀72 mm
45°

	LED		luminaire	
	12,4 W	12,4 W	12,4 W	12,4 W
Power	12,4 W	12,4 W	12,4 W	12,4 W
Flux	1200 lm	1265 lm	355 lm	375 lm
CCT	3000 K	4000 K	3000 K	4000 K
CRI	=80 (min.)			
Color tolerance	MacAdam 3SDCM			
Service life	L70(9K) > 54000h			
Beam			20°	20°
Efficiency			30%	30%
Efficacy	96,8 lm/W	102 lm/W	28,7 lm/W	30,2 lm/W

		12.4 W		3000 K		α=20°		4000 K		α=20°	
		H m	Ø m	EMax lux	EM lux	H m	Ø m	EMax lux	EM lux		
	1	0,36	1430	888	1	0,36	1511	938			
	2	0,73	357	222	2	0,73	378	234			
	3	1,09	159	99	3	1,09	168	104			
	4	1,45	89	55	4	1,45	94	59			
	5	1,82	57	36	5	1,82	60	38			

	LED		luminaire	
	12,4 W	12,4 W	12,4 W	12,4 W
Power	12,4 W	12,4 W	12,4 W	12,4 W
Flux	1200 lm	1265 lm	285 lm	300 lm
CCT	3000 K	4000 K	3000 K	4000 K
CRI	=80 (min.)			
Color tolerance	MacAdam 3SDCM			
Service life	L70(9K) > 54000h			
Beam			32°	32°
Efficiency			23,6%	23,6%
Efficacy	96,8 lm/W	102 lm/W	22,8 lm/W	24 lm/W

		13 W		3000 K		α=32°		4000 K		α=32°	
		H m	Ø m	EMax lux	EM lux	H m	Ø m	EMax lux	EM lux		
	1	0,60	595	345	1	0,60	627	363			
	2	1,20	149	86	2	1,20	157	91			
	3	1,80	66	38	3	1,80	70	40			
	4	2,40	37	22	4	2,40	39	23			
	5	3,00	24	14	5	3,00	25	15			



Rastaf 86

White Black Gold Chrome Metal Grey



QR-CBC51 (GU5,3)

W	Weight	Color
12 V	0,15 kg	○
max 50 W		●
		●
		●
		●

Fix

Code
M049000
M049010
M049070
M049080
M049060

Adjustable

Code
M049005
M049015
M049075
M049085
M049065

Driver 12Vdc SELV supplied separately.



QR-CBC51 (GU5,3)

W	Weight	IP	Color
12 V max 50 W	0,15 kg	▼ IP21/ ▲ IP44	○

Fix

Code
M049100

Adjustable

Code
M049105

Driver 12Vdc SELV supplied separately.



HIPAR51-CE-P (GX10)

W	Weight	Color
max 35W	0,15 kg	○

Fix

Code
M048800

Adjustable

Code
M048805

Driver 220/240Vac 50/60Hz supplied separately.

LED (GU10)

W	Weight	Color
230-240V	0,15 kg	○

Fix

Code
M047900

Adjustable

Code
M047905

IP20 960° ∅72 mm

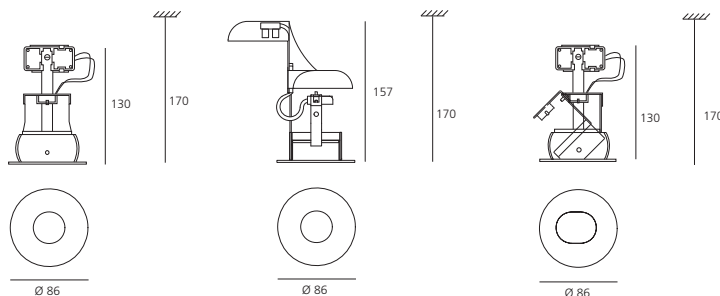

Rastaf 86 LED square

LED

W (LED)	Weight	Beam	Flux	CCT	Color
13 W	0,68 kg	20°	252 lm	3000 K	○
			270 lm	4000 K	○
		32°	201 lm	3000 K	○
			215 lm	4000 K	○

Fixed optic

Code
M039100
M039400
M039300
M039600

Adjustable optic

Code
M039105
M039405
M039305
M039605

Driver 350 mA SELV supplied separately.



▼ IP20 / ▲ IP44 ∅72 mm

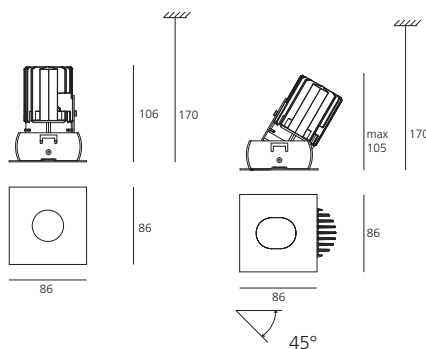

IP20 ∅72 mm

Control gears



Electronic transformer 230 240V/12V
Class II. Dimmable by trailing or leading edge external dimmers.

10-60W	123x32x23mm
35-105W	102x51x30mm
35-150W	100x38x34mm

Code

M070211
M070412
M072111



Electronic ballast 230-240V
Class I
For HIPAR51 (GX10)

1x35W	132x64x37mm
-------	-------------

M070032



Independent LED power supply.
Non dimmable.
Please contact the retailer if you require different configurations.
Output power: 19 W.
Supply voltage: 220-240 V.
Output current: 350 mA.
SELV. IP20. Insulation class II.
Dimensions: 125 x 38 x 23 mm.
Weight: 0,08 kg.

M077500



Independent LED power supply.
Dali dimmable, Push, 0-10 V.
Please contact the retailer if you require different configurations.
Output power: 16W.
Supply voltage: 220-240 V.
Output current: 350 mA.
SELV. IP20. Insulation class II.
Dimensions: 156 x 51,5 x 25,5 mm.
Weight: 0,05 kg.

M077401

Accessories



Recessing ring with plaster support for Rastaf 86 fixed or adjustable.

190x190

Code

M080008



Recessing ring for mineral fiber false ceilings for Rastaf 86 fixed or adjustable.

∅78 mm

M080018



Aluminium recessing ring for Rastaf 86 fixed or adjustable.

∅78 mm

M080028



Steel recessing ring with springs for plasterboard false ceilings for Rastaf 86 fixed or adjustable.

∅78 mm

M080038



Steel recessing plate for 2 spots for Rastaf 86 fixed or adjustable.

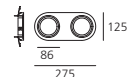

260x∅78 mm

M017300



Steel recessing plate for 3 spots for Rastaf 86 fixed or adjustable.

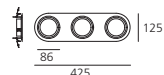

410x∅78 mm

M017400

Toplite

Studio Artemide
2000



- Series of recessed, fixed and adjustable, rounded and square appliances.
- High-yield 3000K and 4000K white led versions, with 3 different beam emission options.
- Die-cast aluminium or steel body.
- Aluminium support, reflector with low-luminance ring.
- IP44 version with integrated cover for electrical elements and protection glass.
- Separate power unit.
- Complies with standard EN60598-1 and other specific standards.



Toplite LED round

○
White

W (LED)	Weight	Beam	Flux	CCT	Color	Code
12 W	0,65 kg	30°	735 lm	3000 K	○	M041800
			775 lm	4000 K	○	M041900
		52°	755 lm	3000 K	○	M042200
			795 lm	4000 K	○	M042300

Electronic ballast 350 mA SELV supplied separately.



IP20

∅75

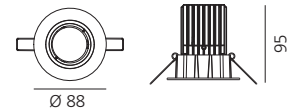

Toplite LED square

W (LED)	Weight	Beam	Flux	CCT	Color	Code
12 W	0,68 kg	30°	735 lm	3000 K	○	M044200
			775 lm	4000 K	○	M044300
		52°	755 lm	3000 K	○	M044600
			795 lm	4000 K	○	M044700

Electronic ballast 350 mA SELV supplied separately.



IP20

∅75

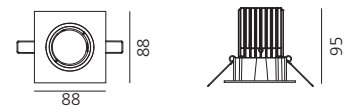

12 W 3000 K α=30° 4000 K α=30°

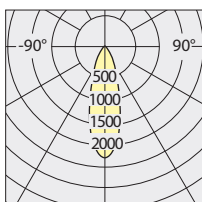

H m	∅ m	E _{Max} lux	E _M lux	H m	∅ m	E _{Max} lux	E _M lux
1	0,55	1667	1018	1	0,55	1758	1073
2	1,11	417	254	2	1,11	439	268
3	1,66	185	113	3	1,66	195	119
4	2,22	104	64	4	2,22	110	67
5	2,77	67	41	5	2,77	70	43

cd/klm

12 W 3000 K α=52° 4000 K α=52°

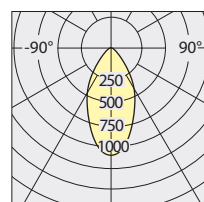

H m	∅ m	E _{Max} lux	E _M lux	H m	∅ m	E _{Max} lux	E _M lux
1	0,99	802	417	1	0,99	844	439
2	1,98	200	104	2	1,98	211	110
3	2,97	89	46	3	2,97	94	49
4	3,96	50	26	4	3,96	53	27
5	4,95	32	17	5	4,95	34	18

cd/klm

Power supply units



Independent LED power supply.
Non dimmable.
Please contact the retailer if you require different configurations.
Output power: 15 W.
Supply voltage: 220-240 V.
Output current: 350 mA.
SELV. IP20. Insulation class II.
Dimensions: 125 x 38 x 23 mm.
Weight: 0,08 kg.

Code
M077500



Independent LED power supply.
Dali dimmable, Push, 0-10V.
Please contact the retailer if you require different configurations.
Output power: 16W.
Supply voltage: 220-240 V.
Output current: 350 mA.
SELV. IP20. Insulation class II.
Dimensions: 156 x 51,5 x 25,5 mm.
Weight: 0,05 kg.

Code
M077401



Nothing Downlight

Ernesto Gismondi
2005



Vertical position

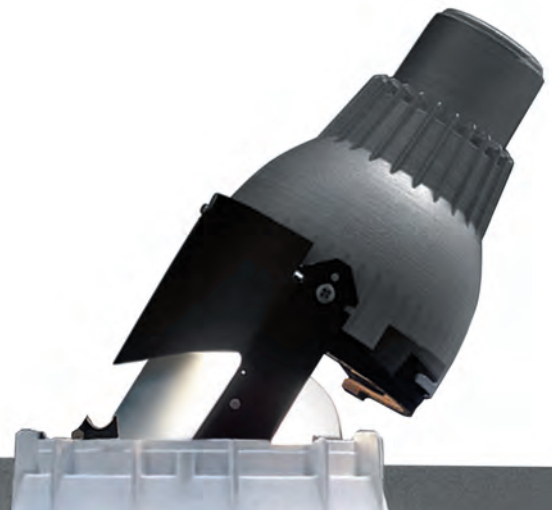

Maximum tilt

- A range of fixed and adjustable downlights using LED, 12V halogen and metal halide lamps.
- 2 diameter options: $\varnothing 105$ and $\varnothing 155$ mm.
- Tilt angle of up to 32° .
- Optional ring in injection moulded plastic with white finish for an installation without plaster finish coat. Fitting by one quarter turn rotation.



Nothing recessed round Ø105 fixed/adjustable

					Fixed	Adjustable
W (LED)	Weight	Beam	Flux	CCT	Code	Code
12 W	0,55 kg	30°	735 lm	3000 K	M062300	M062305
			775 lm	4000 K	M062500	M062505
		52°	755 lm	3000 K	M065200	M065205
			795 lm	4000 K	M065300	M065305



Electronic ballast 350 mA SELV supplied separately.

Driver	Vac	L _{mm}	W _{mm}	H _{mm}	n°device		Code
cc 15W 350mA	220-240	125	38	23	1 max	Non dimmable	M074600
cc 16W 350mA	220-240	156	52	26	1 max	DALI dimmable	M077401

IP20 ☉ 96°

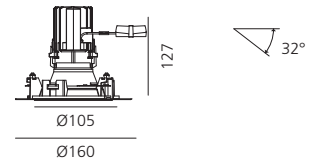
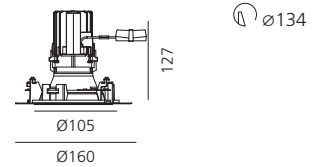

12 W 3000 K $\alpha=30^\circ$ 4000 K $\alpha=30^\circ$

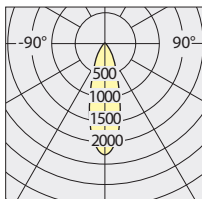

H _m	Ø _m	E _{Max} _{lux}	E _M _{lux}	H _m	Ø _m	E _{Max} _{lux}	E _M _{lux}
1	0,55	1667	1018	1	0,55	1758	1073
2	1,11	417	254	2	1,11	439	268
3	1,66	185	113	3	1,66	195	119
4	2,22	104	64	4	2,22	110	67
5	2,77	67	41	5	2,77	70	43

12 W 3000 K $\alpha=52^\circ$ 4000 K $\alpha=52^\circ$

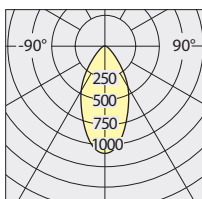

H _m	Ø _m	E _{Max} _{lux}	E _M _{lux}	H _m	Ø _m	E _{Max} _{lux}	E _M _{lux}
1	0,99	802	417	1	0,99	844	439
2	1,98	200	104	2	1,98	211	110
3	2,97	89	46	3	2,97	94	49
4	3,96	50	26	4	3,96	53	27
5	4,95	32	17	5	4,95	34	18

Nothing recessed round Ø105 fixed/adjustable

QR-CBC51 (GU5,3)

W	Weight
12V max50 W	0,40 kg

Retrofit ► MASTER LEDspot MR16 (GU5,3) 12V 7 W
Electronic ballast 12V SELV supplied separately.

Fixed

Code
M062620

Adjustable

Code
M064020

HIPAR51-CE-P (GX10)

W	Weight
max35 W	0,40 kg

Electronic ballast supplied separately.

Fixed

Code
M062720

Adjustable

Code
M064120

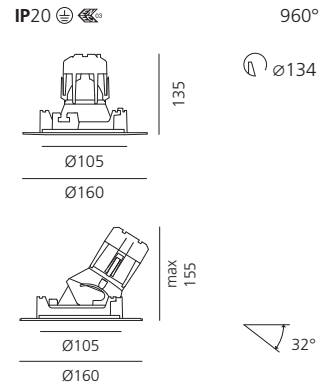

Accessories



Ring in injection moulded plastic.
Ø165mm

Color
○

Code
M064900

Control gears



Electronic transformer 230-240 V / 12 V.
Class II. Dimmable by trailing
or leading edge external dimmers.

10-60W. 123x32x23mm.
35-105W. 102x51x30mm.

Code
M070211
M070412



Electronic ballast 230-240V.
Class I.

For HIPAR-CE-P (GX10) 1x35W.
132x64x37mm.

M070032

Nothing recessed round Ø155 adjustable

QR-111 (G53)

Adjustable

W	Weight
12V max100 W	1,20 kg

Code
M064420

Electronic ballast 12V SELV supplied separately.

HIR111-CE-P (G8,5)

Adjustable

W	Weight
35/70 W	1,20 kg

Code
M064720

Electronic ballast supplied separately.

HIT-TC-CE (G8,5)

Adjustable

W	Weight	Beam
20/35/70 W	1,30 kg	20°
		40°

Code
M064620
M063220

Electronic ballast supplied separately.

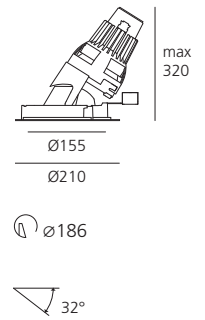

IP20

960°

20W/1700lm

Efficiency 45% $\alpha=20^\circ$

35W/3400lm

Efficiency 46% $\alpha=20^\circ$

70W/6600lm

Efficiency 46% $\alpha=20^\circ$

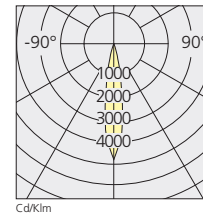
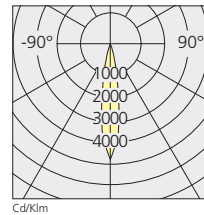
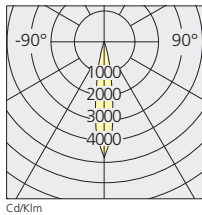

20W/1700lm

Efficiency 70% $\alpha=40^\circ$

35W/3400lm

Efficiency 70% $\alpha=40^\circ$

70W/6600lm

Efficiency 70% $\alpha=40^\circ$

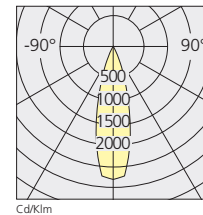
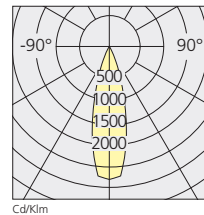
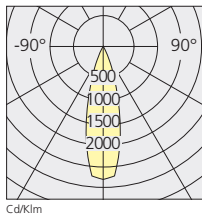

Accessories



Ring in injection moulded plastic.
Ø215mmmm

Color
○

Code
M065000



UV filter
For Nothing Ø155mm HIT series.

M080085

HIT-CE (G12)
Adjustable

W	Weight	Beam	Code
70 W	1,30 kg	20°	M063520
		40°	M063620
150 W	1,30 kg	20°	M064820
		40°	M063320

Electronic ballast supplied separately.

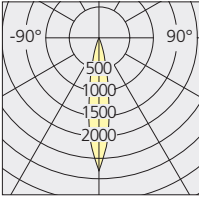
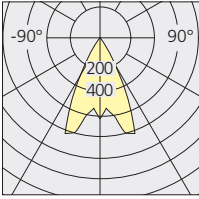
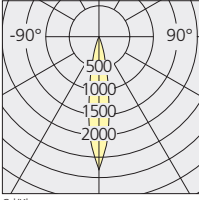
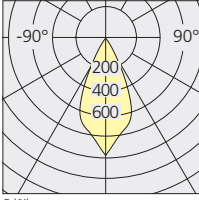
70W/6600lm	Efficiency 36%	$\alpha=20^\circ$	70W/6600lm	Efficiency 55%	$\alpha=40^\circ$				
	H m	\varnothing m	EMax lux	EM lux		H m	\varnothing m	EMax lux	EM lux
	1	0,30	19057	9271		1	1,00	4454	2014
	2	0,59	4764	2318		2	1,99	1113	503
	3	0,89	2117	1030		3	2,99	495	224
	4	1,18	1191	579		4	3,99	278	126
	5	1,48	762	371		5	4,99	178	81
	H m	\varnothing m	EMax lux	EM lux		H m	\varnothing m	EMax lux	EM lux
	1	0,30	40424	19665		1	0,85	12183	4749
	2	0,59	10106	4916		2	1,71	3046	1187
	3	0,89	4492	2185		3	2,56	1354	528
	4	1,18	2526	1229		4	3,41	761	297
	5	1,48	1617	787		5	4,27	487	190

Control gears
Code

Electronic transformer 230-240 V / 12 V.
Class II. Dimmable by trailing or leading edge external dimmers.

10-60W. 123x32x23mm.
35-105W. 102x51x30mm.

M070211
M070412



Electronic ballast 230-240V.
Class I.

HIT 1x35W. 155x83x32mm.
HIT 1x70W. 150x80x35mm.
HIT 1x150W. 150x90x40mm.

M070322
M070522
M070622

Java Downlight

Ernesto Gismondi
2005

- Fixed downlights using LED, 12V dichroic halogen and 230-240 V and led lamps.
- 2 versions: trim and trimless.
- Body is made from steel, lampholding ring from aluminium.
- 2 lighting options: downlighting (vertical) and wall washer lighting (30°).

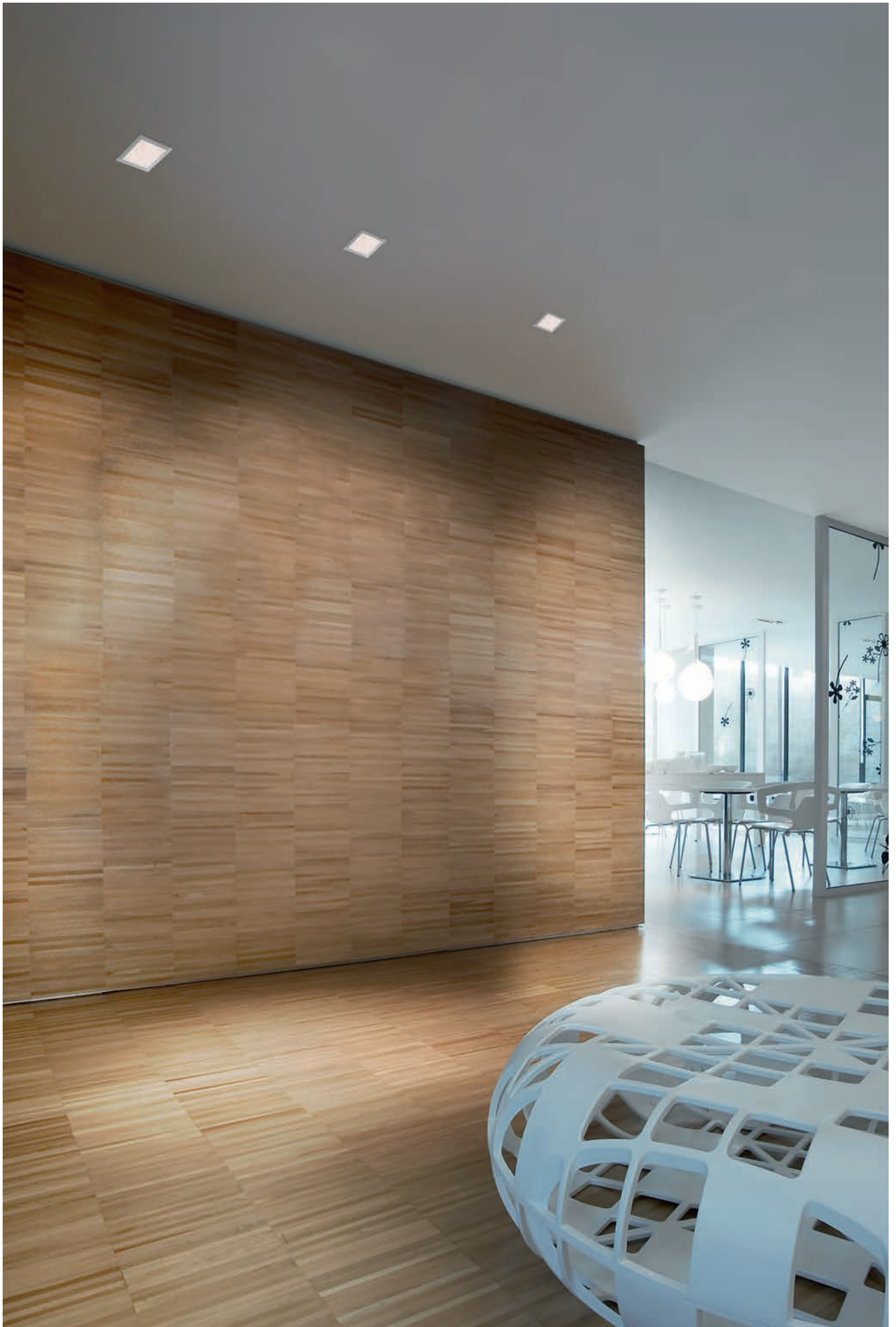

Java Downlight

White
○

						Trim	Trimless
W (LED)	Weight	Beam	Flux	CCT	Color	Code	Code
12 W	0,65 kg	30°	735 lm	3000 K	○	M129820	M133600
			775 lm	4000 K	○	M129920	M133700
		52°	755 lm	3000 K	○	M137620	M135200
			795 lm	4000 K	○	M137720	M136700

Electronic ballast 350 mA SELV supplied separately.

Driver	Vac	L _{mm}	W _{mm}	H _{mm}	n°device		Code
cc 15W 350mA	220-240	125	38	23	1 max	Non dimmable	M074600
cc 16W 350mA	220-240	156	52	26	1 max	DALI dimmable	M077401



IP20

960°

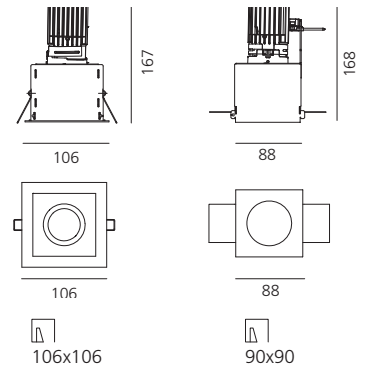

12 W 3000 K α=30° 4000 K α=30°

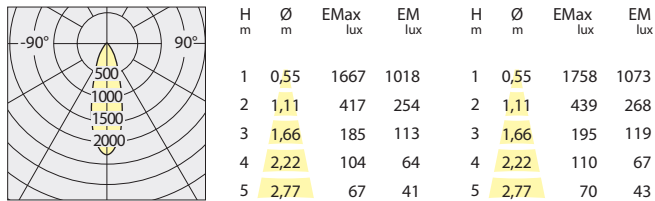

12 W 3000 K α=52° 4000 K α=52°

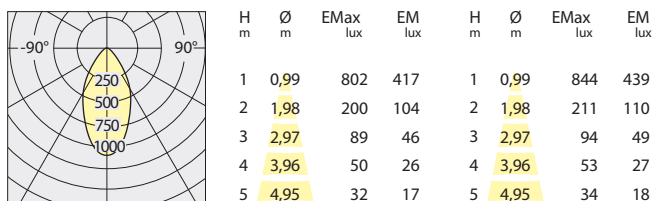

Java Downlight

White
○

Downlight

LED (GU10)		
W	Weight	Color
230-240 V	0,60 kg	○
*Max 81mm (overall)		

Trim
Code M138820

Trimless
Code M137800

QR-CBC51 (GU5,3)		
W	Weight	Color
12V 1xmax50 W	0,45 kg	○
retrofit ► MASTER LEDspot MR16 (GU5,3) 12V 7 W Electronic ballast 12V SELV supplied separately		

Trim
Code M139420

Trimless
Code M139000

HIPAR51-CE-P (GX10)		
W	Weight	Color
1xmax35 W	0,45 kg	○
Electronic ballast supplied separately		

Trim
Code M139520



IP20

96°

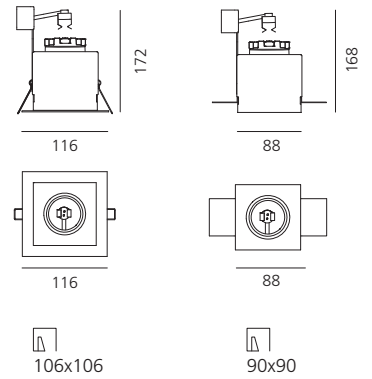

Wall washer

LED (GU10)		
W	Weight	Color
230-240 V	0,70 kg	○
*Max 81mm (overall)		

Trim
Code M138920

Trimless
Code M137900

QR-CBC51 (GU5,3)		
W	Weight	Color
12V 1xmax50 W	0,55 kg	○
Retrofit ► MASTER LEDspot MR16 (GU5,3) 12V 7 W. Electronic ballast 12V SELV supplied separately.		

Trim
Code M139720

Trimless
Code M139200

HIPAR51-CE-P (GX10)		
W	Weight	Color
1xmax35 W	0,55 kg	○

Trim
Code M139820

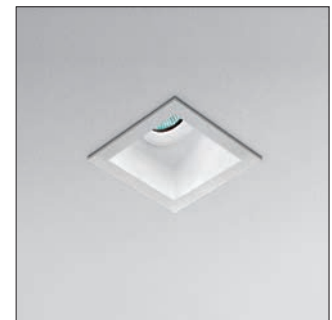

IP20

96°

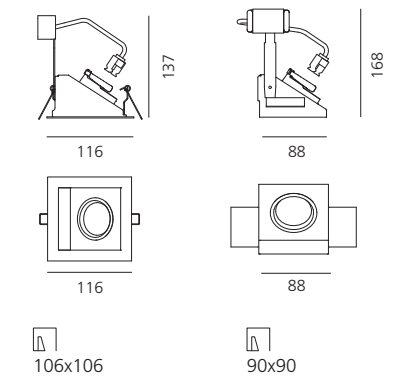

Independent power supply to be ordered separately.

Control gears



Electronic transformer 10-60 W 230-240 V
Class II. Dimmable by trailing or leading edge external dimmers.
10-60 W. 123x32x23 mm

Code
M070211



Electronic ballast 230-240 V
Class I
HIT 1x35 W. 155x83x32 mm

Code
M070322

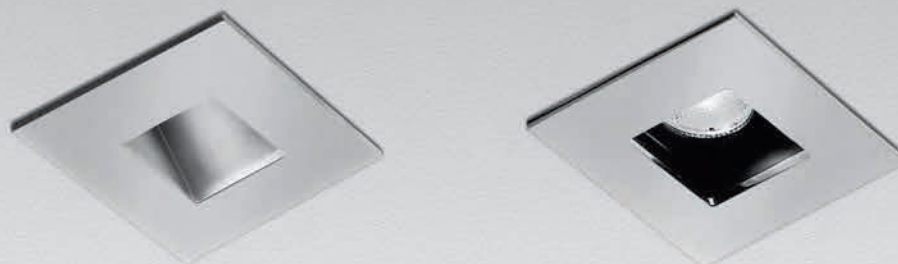

- Light fixture with high-performance LED light sources.
- Ceiling installation.
- Low recessed depth
- Consists of: body, frame, black silkscreened tempered glass, fixing springs.
- Body in EN AB44100 aluminium, silicone gaskets.
- Frame in aluminium.
- Black silkscreened tempered glass, 4mm-thick (IP65).
- Fixing springs in harmonic steel.
- Power connection to the mains by means of a H05RN-r cable and IP68 electrical terminal board, supplied with the fixture (IP65).
- Glass surface temperature lower than 40°C.
- Fixed optics. PMMA lenses in 2 different versions of beams.
- White monochromatic LEDs available in 2 colour temperatures:
Warm = 3000K
Neutral = 4000K
- Painted die-cast aluminium with 3-stage outdoor treatment: nanotechnologies, antioxydant primer, polyester paint (IP65).
- Technical features of light fixtures in compliance with EN60598-1.
- IP Rating IP65 or IP40.
- Insulation class III.
- Installation must be carried out by specialised personnel.
- Carefully follow the instructions

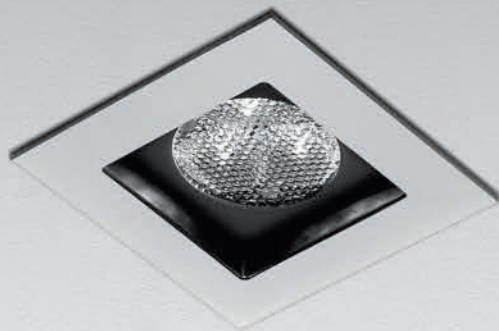



Zeno Up 1

White Silver Chrome

LED CRI = 80(min)

W	Weight	Beam	Efficacy	Flux	CCT	Color	Code
2 W	0,13 kg	10°	37 lm/W	110 lm	3000K	<input checked="" type="radio"/>	NL708610K0
			48 lm/W	145 lm	4000K	<input checked="" type="radio"/>	NL708610W0

Driver	Vac	L _{mm}	W _{mm}	H _{mm}	n°device		
cc 10W 700mA	220-240	75	38	22	1min-3max	Non dimmable	NL19035



IP40 CE

40 x 27

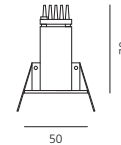

Zeno Up 2

LED CRI = 80(min)

W	Weight	Beam	Flux	CCT	Color	IP65	Code	IP40	Code
2 W	0,25 kg	14°	128 lm	3000K	<input checked="" type="radio"/>	IP65	NL1708410K002	IP40	NL1708110K002
					<input checked="" type="radio"/>		NL1708410K003		NL1708110K003
					<input type="radio"/>		NL1708410K006		NL1708110K006
		24°	137 lm	4000K	<input checked="" type="radio"/>	NL1708410W002	NL1708110W002		
					<input checked="" type="radio"/>	NL1708410W003	NL1708110W003		
					<input type="radio"/>	NL1708410W006	NL1708110W006		
2 W	0,25 kg	14°	133 lm	3000K	<input checked="" type="radio"/>	IP65	NL1708425K002	IP40	NL1708125K002
					<input checked="" type="radio"/>		NL1708425K003		NL1708125K003
					<input type="radio"/>		NL1708425K006		NL1708125K006
		24°	142 lm	4000K	<input checked="" type="radio"/>	NL1708425W002	NL1708125W002		
					<input checked="" type="radio"/>	NL1708425W003	NL1708125W003		
					<input type="radio"/>	NL1708425W006	NL1708125W006		

Driver	Vac	L _{mm}	W _{mm}	H _{mm}	IP	n°device		
cc 11W 700mA	220-240	145	65	55	67	1min-4max	Non dimmable	NL19024
cc 10W 700mA	220-240	75	38	22		1min-4max	Non dimmable	NL19035



CE

38 x 36

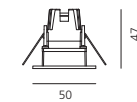

Zeno Up 2

LED	luminaire	2 W	3000 K	α=14°	4000 K	α=14°
Power	2 W	2 W	2 W	2 W		
Flux	168 lm	180 lm	128 lm	137 lm		
CCT	3000 K	4000 K	3000 K	4000 K		
CRI	=80 (typ.)					
Color tolerance	MacAdam 4SDCM					
Service life	L70(6K) > 39300h					
Beam		14°	14°			
Efficiency		76%	76%			
Efficacy	80 lm/W	86 lm/W	61 lm/W	65 lm/W		

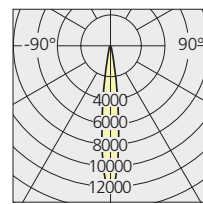

cd/klm

Zeno Up 2

LED	luminaire	2 W	3000 K	α=24°	4000 K	α=24°
Power	2 W	2 W	2 W	2 W		
Flux	168 lm	180 lm	133 lm	142 lm		
CCT	3000 K	4000 K	3000 K	4000 K		
CRI	=80 (typ.)					
Color tolerance	MacAdam 4SDCM					
Service life	L70(6K) > 39300h					
Beam		24°	24°			
Efficiency		79%	79%			
Efficacy	80 lm/W	86 lm/W	63 lm/W	68 lm/W		

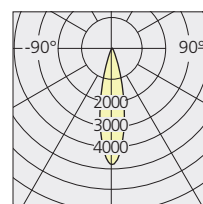

cd/klm

Zeno Up 3

White Silver Chrome

LED CRI = 80(min)

W	Weight	Beam	Flux	CCT	Color
5 W	0,45 kg	16°	269 lm	3000K	<input checked="" type="radio"/>
					<input type="radio"/>
			286 lm	4000K	<input checked="" type="radio"/>
		<input type="radio"/>			
		24°		280 lm	3000K
			<input type="radio"/>		
298 lm	4000K		<input checked="" type="radio"/>		
		<input type="radio"/>			
		<input type="radio"/>			

IP65

Code
NL1708510K002
NL1708510K003
NL1708510K006
NL1708510W002
NL1708510W003
NL1708510W006
NL1708525K002
NL1708525K003
NL1708525K006
NL1708525W002
NL1708525W003
NL1708525W006

IP40

Code
NL1708310K002
NL1708310K003
NL1708310K006
NL1708310W002
NL1708310W003
NL1708310W006
NL1708325K002
NL1708325K003
NL1708325K006
NL1708325W002
NL1708325W003
NL1708325W006



52 x 56

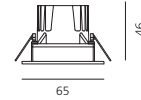

Driver	Vac	L _{mm}	W _{mm}	H _{mm}	IP	n°device	
cc 14W 500mA	220-240	145	65	55	67	1min-2max	Non dimmable
cc 10W 500mA	220-240	75	38	22		1	Non dimmable

NL19046

NL10941

Zeno Up 3

LED	luminaire			
5 W	5 W	5 W	5 W	
384 lm	408 lm	269 lm	286 lm	
3000 K	4000 K	3000 K	4000 K	
CRI =80 (typ.)				
Color tolerance	MacAdam 4SDCM			
Service life	L70(6K) > 39300h			
Beam		16°	16°	
Efficiency		70%	70%	
Efficacy	80 lm/W	85 lm/W	56 lm/W	60 lm/W

5 W	3000 K		α=16°		4000 K		α=16°	
	H _m	Ø _m	EMax _{lux}	EM _{lux}	H _m	Ø _m	EMax _{lux}	EM _{lux}
	1	0,29	2909	1713	1	0,29	3093	1821
	2	0,57	727	428	2	0,57	773	455
	3	0,86	323	190	3	0,86	344	202
	4	1,14	182	107	4	1,14	193	114
	5	1,43	116	69	5	1,43	124	73

Zeno Up 3

LED	luminaire			
5 W	5 W	5 W	5 W	
384 lm	408 lm	280 lm	298 lm	
3000 K	4000 K	3000 K	4000 K	
CRI =80 (typ.)				
Color tolerance	MacAdam 4SDCM			
Service life	L70(6K) > 39300h			
Beam		24°	24°	
Efficiency		73%	73%	
Efficacy	80 lm/W	85 lm/W	58 lm/W	62 lm/W

5 W	3000 K		α=24°		4000 K		α=24°	
	H _m	Ø _m	EMax _{lux}	EM _{lux}	H _m	Ø _m	EMax _{lux}	EM _{lux}
	1	0,42	1325	833	1	0,42	1410	886
	2	0,84	331	208	2	0,84	352	222
	3	1,26	147	93	3	1,26	157	98
	4	1,68	83	52	4	1,68	88	55
	5	2,10	53	33	5	2,10	56	35

Zeno Up 4

White Silver Chrome

LED CRI = 80(min)						
W	Weight	Beam	Flux	Efficacy	CCT	Color
6,5 W	0,60 kg	10°	364 lm	58 lm/W	3000K	<input checked="" type="radio"/>
						<input type="radio"/>
						<input type="radio"/>
		30°	376 lm	60 lm/W	3000K	<input checked="" type="radio"/>
						<input type="radio"/>
						<input type="radio"/>
402 lm	64 lm/W	4000K	4000K	<input checked="" type="radio"/>		
				<input type="radio"/>		
				<input type="radio"/>		
		4000K	4000K	<input checked="" type="radio"/>		
				<input type="radio"/>		
				<input type="radio"/>		

IP65
Code
NL1708610K002
NL1708610K003
NL1708610K006
NL1708610W002
NL1708610W003
NL1708610W006
NL1708625K002
NL1708625K003
NL1708625K006
NL1708625W002
NL1708625W003
NL1708625W006

IP40
Code
NL1708710K002
NL1708710K003
NL1708710K006
NL1708710W002
NL1708710W003
NL1708710W006
NL1708725K002
NL1708725K003
NL1708725K006
NL1708725W002
NL1708725W003
NL1708725W006

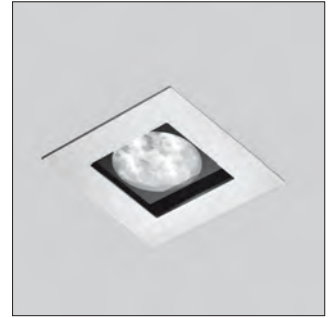

79 x 79

Driver	Vac	L _{mm}	W _{mm}	H _{mm}	IP	n°device
cc 14W 500mA	220-240	145	65	55	67	1
cc 8W 500mA slim	220-240	75	38	22		1

Non dimmable	NL19046
Non dimmable	NL10941

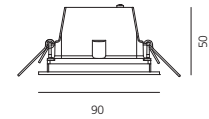

Zeno Up 4	LED	luminaire	
Power	6,5 W	6,5 W	6,5 W
Flux	520 lm	556 lm	364 lm
CCT	3000 K	4000 K	3000 K
CRI	=80 (typ.)		
Color tolerance	MacAdam 4SDCM		
Service life	L70(6K) > 39300h		
Beam		10°	10°
Efficiency		70%	70%
Efficacy	83 lm/W	88 lm/W	62 lm/W

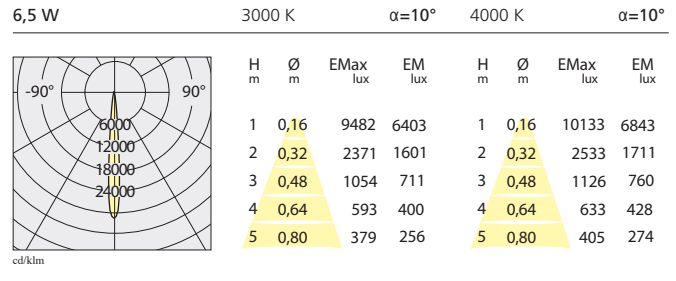

Zeno Up 4	LED	luminaire	
Power	6,5 W	6,5 W	6,5 W
Flux	520 lm	556 lm	376 lm
CCT	3000 K	4000 K	3000 K
CRI	=80 (typ.)		
Color tolerance	MacAdam 4SDCM		
Service life	L70(6K) > 39300h		
Beam		30°	30°
Efficiency		72%	72%
Efficacy	83 lm/W	88 lm/W	64 lm/W

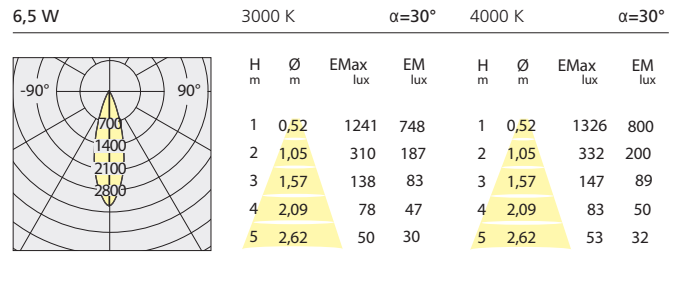

Zeno Up Frosted

Jan Van Lierde
2013



- Light fixture with high-performance LED light sources.
- Wall or ceiling installation.
- Consists of: frame, body, fixing springs.
- Frame in frosted opal glass, 4mm thick.
- Body in injection mould of aluminium.
- Fixing springs in harmonic steel.
- White monochromatic LEDs available in 2 colour temperatures:
Warm = 3000K
Neutral = 4000K
- Electrical connection to the driver by means of a FROR cable and a terminal board.
- IP Rating IP40.
- Insulation class III.
- Technical features of light fixtures in compliance with EN60598-1.
- Installation must be carried out by specialised personnel.
- Carefully follow the instructions.

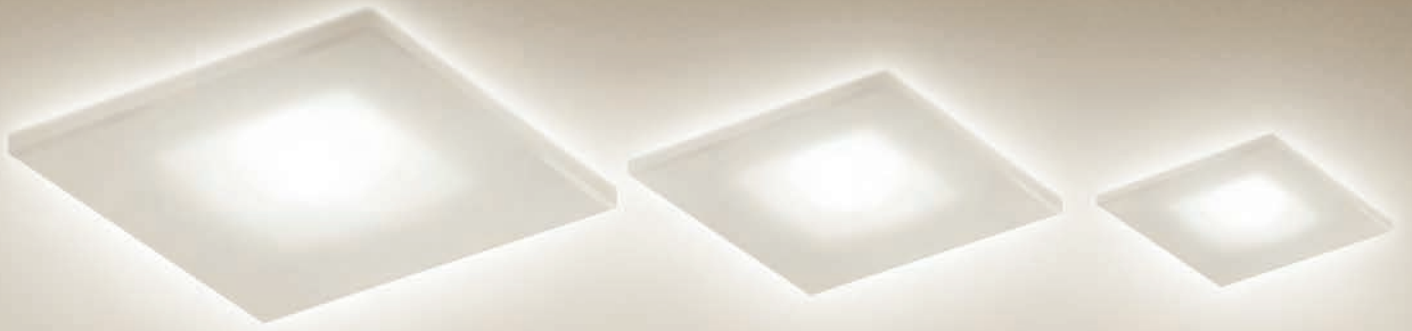

Zeno Up 2 Frosted

LED CRI = 80(min)

Round

Square

W	Weight	Flux	CCT	Code	Code
2 W	0,30 kg	22 lm	3000K	NL17088K0	NL17089K0
		24 lm	4000K	NL17088W0	NL17089W0

Driver	Vac	L _{mm}	W _{mm}	H _{mm}	IP	n°device
cc 10W 700mA	220-240	75	38	22		1 min-4max Non dimmable NL19035

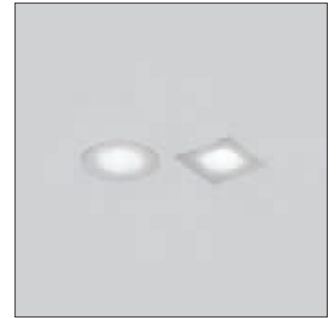

IP40 CE

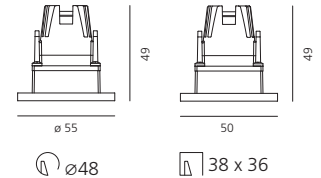

Zeno Up 2 Frosted

LED	luminaire	
Power	2 W	2 W
Flux	168 lm	180 lm
CCT	3000 K	4000 K
CRI	=80 (min.)	
Color tolerance	MacAdam 4SDCM	
Service life	L70(6K) > 39300h	
Beam	56°	56°
Efficiency	13%	13%
Efficacy	80 lm/W	86 lm/W

2 W 3000 K $\alpha=56^\circ$ 4000 K $\alpha=56^\circ$

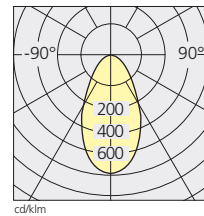

H _m	Ø _m	EMax _{lux}	EM _{lux}	H _m	Ø _m	EMax _{lux}	EM _{lux}
1	1,07	17	9	1	1,07	19	10
2	2,14	4	2	2	2,14	5	2
3	3,21	2	1	3	3,21	2	1
4	4,27	1	1	4	4,27	1	1
5	5,34	1	0	5	5,34	1	0

Zeno Up 3 Frosted

LED CRI = 80(min)

Round

Square

W	Weight	Flux	CCT	Code	Code
5 W	0,30 kg	138 lm	3000K	NL17090K0	NL17091K0
		147 lm	4000K	NL17090W0	NL17091W0

Driver	Vac	L _{mm}	W _{mm}	H _{mm}	IP	n°device
cc 8W 500mA slim	220-240	22	110	19		1max Non dimmable NL19041

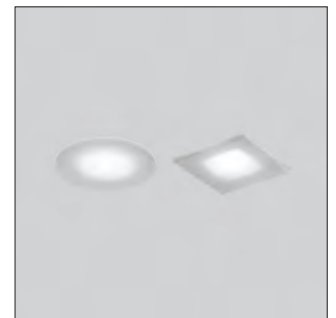

IP40 CE

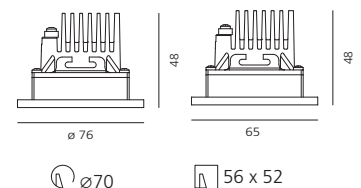

Zeno Up 3 Frosted

LED	luminaire	
Power	5 W	5 W
Flux	384 lm	408 lm
CCT	3000 K	4000 K
CRI	=80 (min.)	
Color tolerance	MacAdam 4SDCM	
Service life	L70(6K) > 39300h	
Beam	76°	76°
Efficiency	36%	36%
Efficacy	80 lm/W	85 lm/W

5 W 3000 K $\alpha=76^\circ$ 4000 K $\alpha=76^\circ$

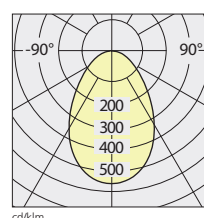

H _m	Ø _m	EMax _{lux}	EM _{lux}	H _m	Ø _m	EMax _{lux}	EM _{lux}
1	1,54	75	33	1	1,54	80	35
2	3,08	19	8	2	3,08	20	9
3	4,62	8	4	3	4,62	9	4
4	6,16	5	2	4	6,16	5	2
5	7,70	3	1	5	7,70	3	1

Zeno Up 4 Frosted

LED CRI = 80(min)				Round	Square
W	Weight	Flux	CCT	Code	Code
10 W	0,30 kg	464 lm	3000K	NL17092K0	NL17093K0
		496 lm	4000K	NL17092W0	NL17093W0

Driver	Vac	L _{mm}	W _{mm}	H _{mm}	IP	n°device
cc 20W 700mA	220-240	125	38	23		1max Non dimmable

NL19036

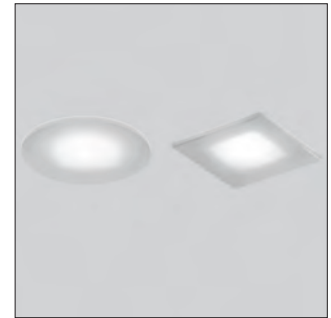

IP40

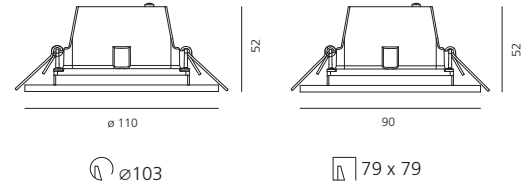

Zeno Up 4 Frosted	LED		luminaire	
Power	8,5 W	8,5 W	8,5 W	8,5 W
Flux	773 lm	827 lm	464 lm	496 lm
CCT	3000 K	4000 K	3000 K	4000 K
CRI	=80 (min.)			
Color tolerance	MacAdam 4SDCM			
Service life	L70(6K) > 39300h			
Beam			87°	87°
Efficiency			60%	60%
Efficacy	91 lm/W	97 lm/W	54,5 lm/W	58,3 lm/W

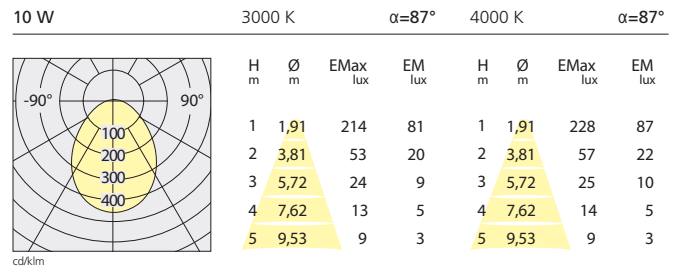

San Lorenzo SL104, Ameglia - IT

Hide

Jan Van Lierde
2012



- Light fixture with high-performance LED light sources.
- Ceiling installation.
- Consists of: housing, body, frame.
- Housing in extruded aluminium (available separately).
- Body in extruded aluminium.
- Frame in injection-mould of plastic, painted.
- White monochromatic LEDs available in 2 colour temperatures:
Warm = 3000K
Neutral = 4000K
- Electrical connection to driver by means of a 2-wire FEP-FEP cable.
- Remote driver.
- IP Rating IP20.
- Insulation class III.
- Technical features of light fixtures in compliance with EN60598-1.
- Installation must be carried out by specialised personnel.
- Carefully follow the instructions.

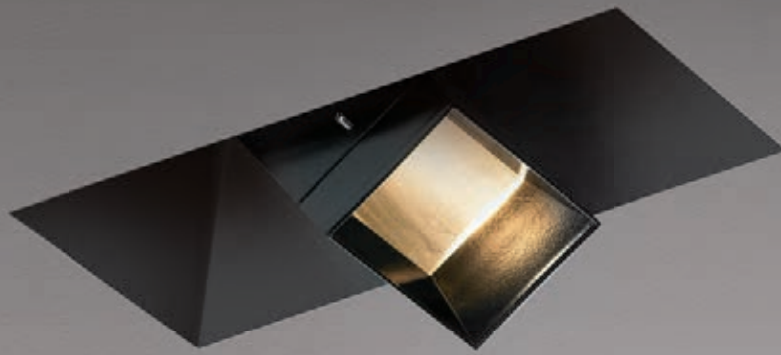
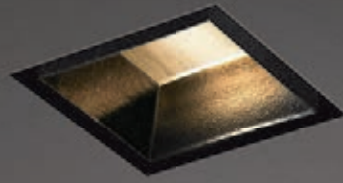
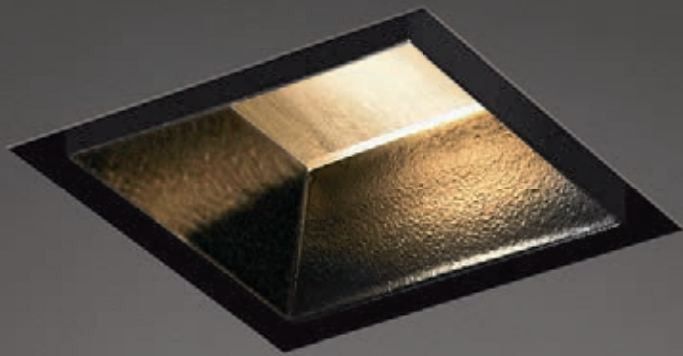

Hide R1

White Black

LED CRI = 80(min)

W	Weight	Beam	Flux	CCT	Color	Code
1,4 W	0,40 kg	10°	31 lm	3000K	●	NL1734010K004
					○	NL1734010K006
			46 lm	4000K	●	NL1734010W004
					○	NL1734010W006

Driver	Vac	L _{mm}	W _{mm}	H _{mm}	n°device
cc 8W 500mA	220-240	22	110	19	1min-5max Non dimmable

Recessing box

NL19041
NL17345H004



IP20

∅55
+2 mm

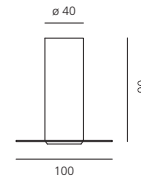

1,4 W 3000 K α=10°

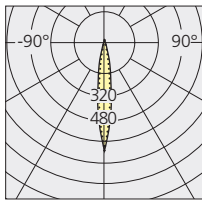

H m	∅C0 m	∅C90 m	E lux
0,5	0,13	0,10	69
1,0	0,25	0,20	17
1,5	0,38	0,30	8
2,0	0,51	0,40	4
2,5	0,63	0,50	3
3,0	0,76	0,60	2

cd/kim

Hide S1

LED CRI = 80(min)

W	Weight	Beam	Flux	CCT	Color	Code
1,4 W	0,40 kg	10°	31 lm	3000K	●	NL1735010K004
					○	NL1735010K006
			46 lm	4000K	●	NL1735010W004
					○	NL1735010W006

Driver	Vac	L _{mm}	W _{mm}	H _{mm}	n°device
cc 8W 500mA	220-240	22	110	19	1min-5max Non dimmable

Recessing box

NL19041
NL17345H004

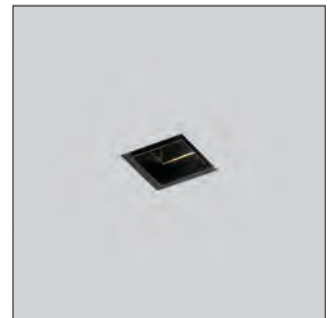

IP20

55 x 55
+2 mm

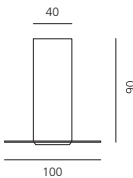

1,4 W 3000 K α=10°

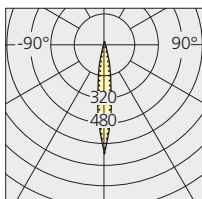

H m	∅C0 m	∅C90 m	E lux
0,5	0,13	0,10	69
1,0	0,25	0,20	17
1,5	0,38	0,30	8
2,0	0,51	0,40	4
2,5	0,63	0,50	3
3,0	0,76	0,60	2

cd/kim

Hide R2

White Black

LED CRI = 80(min)

W	Weight	Beam	Flux	CCT	Color	Code
8,5 W	0,80 kg	18°	564 lm	3000K	<input checked="" type="radio"/>	NL1736218K004
					<input type="radio"/>	NL1736218K006
			673 lm	4000K	<input checked="" type="radio"/>	NL1736218W004
		34°	564 lm	3000K	<input checked="" type="radio"/>	NL1736234K004
					<input type="radio"/>	NL1736234K006
			673 lm	4000K	<input checked="" type="radio"/>	NL1736234W004
				<input type="radio"/>	NL1736234W006	

Driver	Vac	L _{mm}	W _{mm}	H _{mm}	n°device
cc 20W 700mA	220-240	125	38	23	1min-2max Non dimmable

Recessing box

NL19036
NL17345H004



IP20

$\varnothing 90$
+2 mm

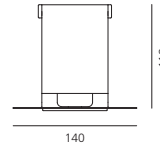

8,5 W 3000 K $\alpha=18^\circ$

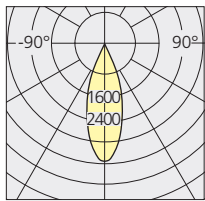

H m	$\varnothing C0$ m	E lux
0,5	0,29	7420
1,0	0,58	1855
1,5	0,88	824
2,0	1,17	464
2,5	1,46	297
3,0	1,75	206

cd/klm

Hide S2

LED CRI = 80(min)

W	Weight	Beam	Flux	CCT	Color	Code
8,5 W	0,80 kg	18°	564 lm	3000K	<input checked="" type="radio"/>	NL1736318K004
					<input type="radio"/>	NL1736318K006
			673 lm	4000K	<input checked="" type="radio"/>	NL1736318W004
		34°	564 lm	3000K	<input checked="" type="radio"/>	NL1736334K004
					<input type="radio"/>	NL1736334K006
			673 lm	4000K	<input checked="" type="radio"/>	NL1736334W004
				<input type="radio"/>	NL1736334W006	

Driver	Vac	L _{mm}	W _{mm}	H _{mm}	n°device
cc 20W 700mA	220-240	125	38	23	1min-2max Non dimmable

Recessing box

NL19036
NL17345H004

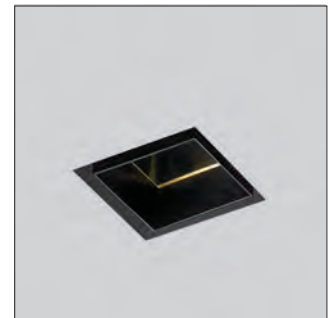

IP20

90 x 90
+2 mm

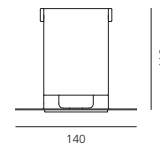

8,5 W 3000 K $\alpha=18^\circ$

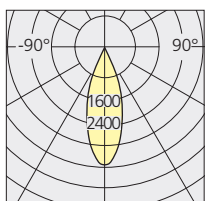

H m	$\varnothing C0$ m	E lux
0,5	0,29	7420
1,0	0,58	1855
1,5	0,88	824
2,0	1,17	464
2,5	1,46	297
3,0	1,75	206

cd/klm





Sait Beyoğlu / İstanbul - TR

Hide R1 Adjustable

White Black

LED CRI = 80(min)

W	Weight	Beam	Flux	CCT	Color	Code
1,4 W	0,60 kg	10°	31 lm	3000K	<input checked="" type="radio"/>	NL1734110K004
					<input type="radio"/>	NL1734110K006
			46 lm	4000K	<input checked="" type="radio"/>	NL1734110W004
					<input type="radio"/>	NL1734110W006

Recessed

Code
NL1754010K004
NL1754010K006
NL1754010W004
NL1754010W006



IP20

55 x 115
+2 mm

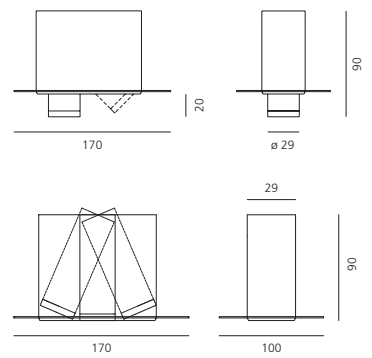

Driver	Vac	L _{mm}	W _{mm}	H _{mm}	n°device
cc 8W 500mA	220-240	22	110	19	1min-5max Non dimmable
Recessing box					<input checked="" type="radio"/>
					<input type="radio"/>
Recessing box for recessed version					<input checked="" type="radio"/>
					<input type="radio"/>

Code
NL19041
NL17346H004
NL17346H006
NL17541H004
NL17541H006

1,4 W

3000 K

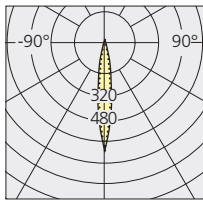

H m	∅C0 m	∅C90 m	E lux
0,5	0,13	0,10	69
1,0	0,25	0,20	17
1,5	0,38	0,30	8
2,0	0,51	0,40	4
2,5	0,63	0,50	3
3,0	0,76	0,60	2

cd/klm

Hide S1 Adjustable

LED CRI = 80(min)

W	Weight	Beam	Flux	CCT	Color	Code
1,4 W	0,60 kg	10°	31 lm	3000K	<input checked="" type="radio"/>	NL1735110K004
					<input type="radio"/>	NL1735110K006
			46 lm	4000K	<input checked="" type="radio"/>	NL1735110W004
					<input type="radio"/>	NL1735110W006

Code
NL19041
NL17346H004
NL17346H006



IP20

55 x 155
+2 mm

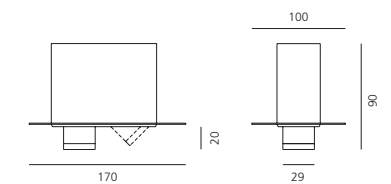

Driver	Vac	L _{mm}	W _{mm}	H _{mm}	n°device
cc 8W 500mA	220-240	22	110	19	1min-5max Non dimmable
Recessing box					<input checked="" type="radio"/>
					<input type="radio"/>

1,4 W

3000 K

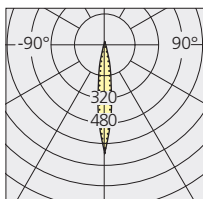

H m	∅C0 m	∅C90 m	E lux
0,5	0,13	0,10	69
1,0	0,25	0,20	17
1,5	0,38	0,30	8
2,0	0,51	0,40	4
2,5	0,63	0,50	3
3,0	0,76	0,60	2

cd/klm

Hide R1L

White Black

LED CRI = 80(min)

W	Weight	Beam	Flux	CCT	Color	Code
4,2 W	0,60 kg	10°	93 lm	3000K	<input checked="" type="radio"/>	NL1734210K004
			138 lm	4000K	<input type="radio"/>	NL1734210K006
					<input checked="" type="radio"/>	NL1734210W004
					<input type="radio"/>	NL1734210W006

Driver	Vac	Lmm	Wmm	Hmm	n°device
cc 8W 500mA	220-240	22	110	19	1max

Recessing box

NL19041
NL17345H004



IP20

55 x 115
+2 mm

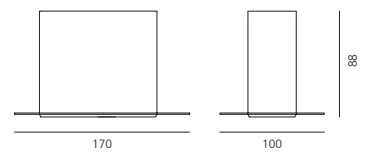

4,2 W

3000 K

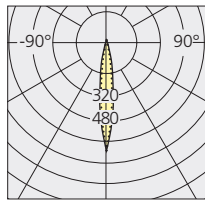

H m	ØC0 m	ØC90 m	E lux
0,5	0,13	0,10	207
1,0	0,25	0,20	51
1,5	0,38	0,30	24
2,0	0,51	0,40	12
2,5	0,63	0,50	9
3,0	0,76	0,60	6

cd/kim

Hide S1L

LED CRI = 80(min)

W	Weight	Beam	Flux	CCT	Color	Code
4,2 W	0,60 kg	10°	93 lm	3000K	<input checked="" type="radio"/>	NL1735210K004
			138 lm	4000K	<input type="radio"/>	NL1735210K006
					<input checked="" type="radio"/>	NL1735210W004
					<input type="radio"/>	NL1735210W006

Driver	Vac	Lmm	Wmm	Hmm	n°device
cc 8W 500mA	220-240	22	110	19	1max

Recessing box

NL19041
NL17345H004



IP20

55 x 155
+2 mm

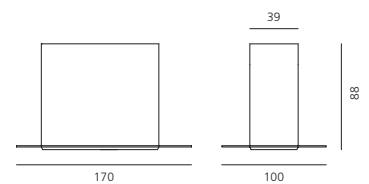

4,2 W

3000 K

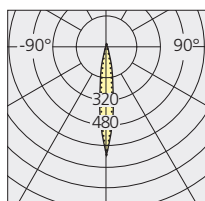

H m	ØC0 m	ØC90 m	E lux
0,5	0,13	0,10	207
1,0	0,25	0,20	51
1,5	0,38	0,30	24
2,0	0,51	0,40	12
2,5	0,63	0,50	9
3,0	0,76	0,60	6

cd/kim



Professional Lighting	298	Algoritmo
	358	Nothing 86
	390	Incipit
	396	Eggboard
	410	Pad System
	418	Grafa
	436	Gradian
	442	Uglare19
	446	Chocolate
	460	Esprit
	468	Surf
	480	Kalifa
	502	Talo
	508	Nota Bene

Algoritmo

Carlotta de Bevilacqua
Paola di Arianello
2010





Algoritmo is an innovative system giving a new method of lighting through an integrated, dynamic dialogue with architecture.

Light becomes a constructive element and an open system, creating different perspectives and functional identities in the space.

5 lighting performances are included in a single, extruded aluminium body: ambient lighting, directional lighting and accent lighting. The versatility of this system enables different lighting configurations to be created without any interruptions and discontinuities between the floor, wall, ceiling and internal space. It is possible to create lines and corners of continuous light on the same plane or at a 90 degree angle. Defined, thin lines are created by the two light sources, fluorescent (white light with different colour temperatures) and LED (dynamic RGB and white light). This makes Algoritmo the perfect architectural

system for multiple spaces: home, office, hospitality, retail, museum. Different installation options – surface recessed, surface mounted, suspended – allow an infinite choice of lighting solutions for every style of architecture.



reddot design award
2011

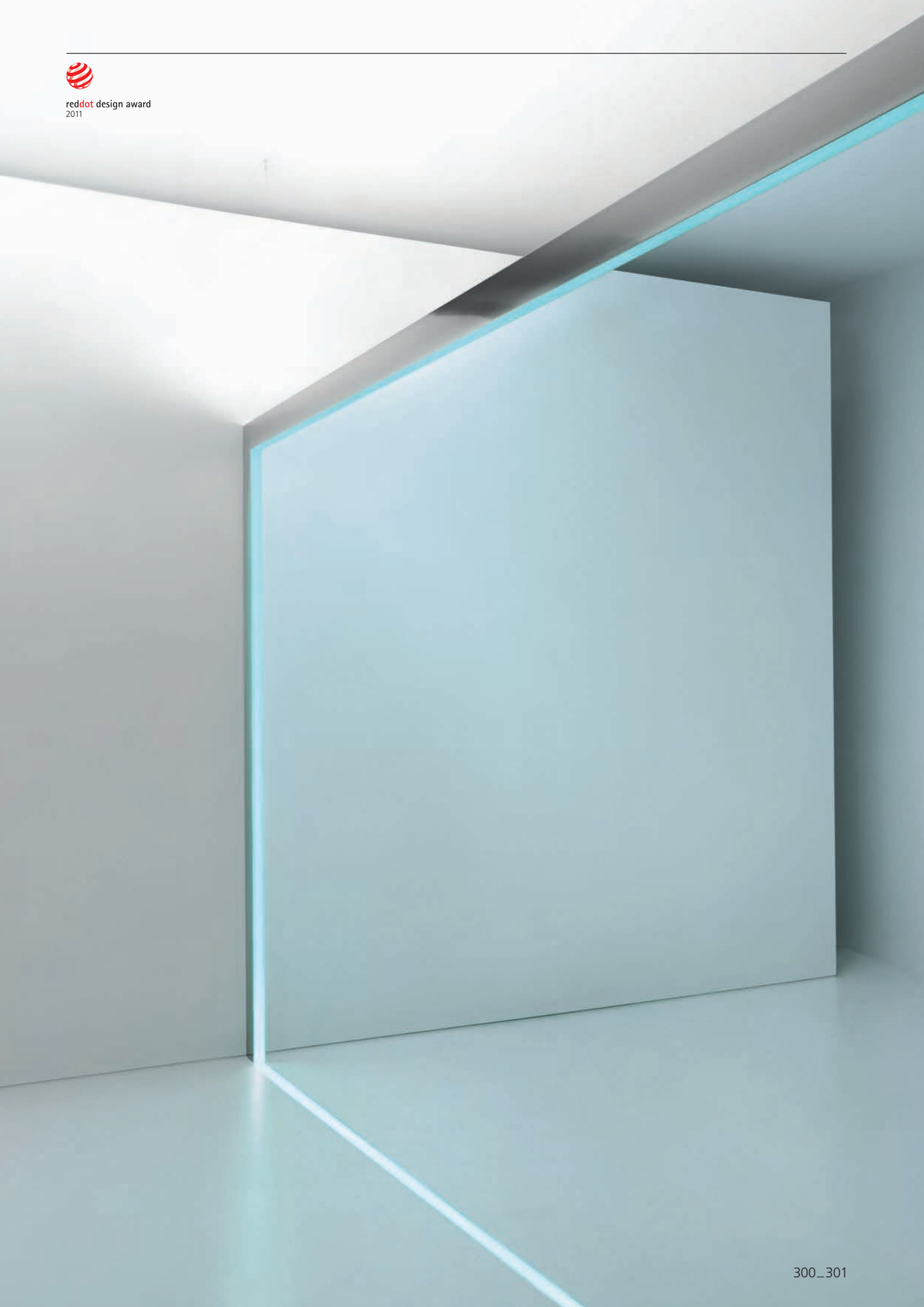









Algoritmo Installation

Algoritmo Floor
floor recessed

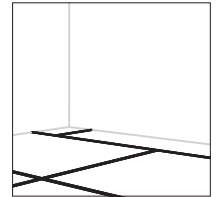
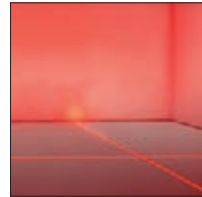

Algoritmo System
wall- or ceiling recessed

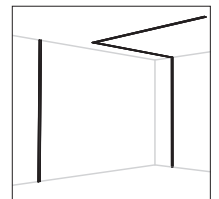
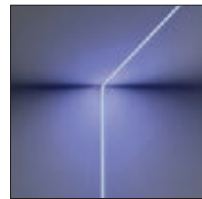

Algoritmo System
Wall/ceiling
surface-mounted
configurations, linear
or at a 90 degree angle.

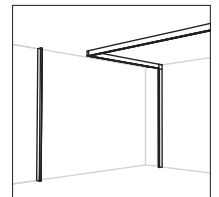
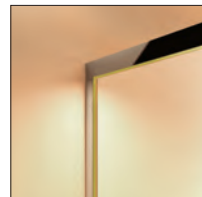

Algoritmo System
Linear or at a 90 degree
angle installations.

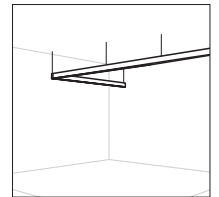

Algoritmo Stand-alone
Suspension

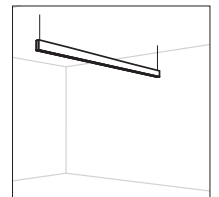

Algoritmo Stand-alone
Surface-mounted
ceiling installation.

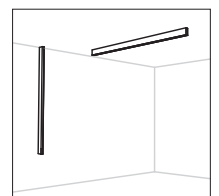
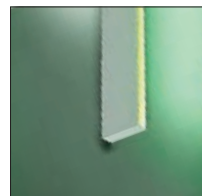

Fluorescent emission

LED/RGB LED emission

LED/RGB LED emission
+ fluorescent indirect

Accent lighting



Indirect emission,
white or RGB diffused LED.

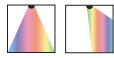
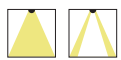

Diffused or dark light fluorescent emission.
Direct emission white or RGB LED,
diffused or wall washer.
Direct emission white LED prismatic and
controlled emission
Accent lighting.

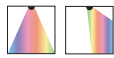
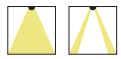

Diffused or dark light fluorescent emission.
Direct emission white or RGB LED,
diffused or wall washer.
Direct emission white LED dark light.
Direct emission white or RGB LED,
diffused or wall washer + fluorescent indirect emission.
Accent lighting.

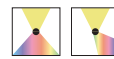
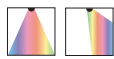
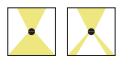
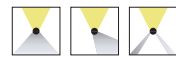
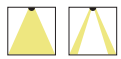

Diffused or dark light fluorescent direct emission.
Direct emission white or RGB LED,
diffused or wall washer.
Direct emission white LED prismatic
and controlled emission.
Accent lighting.
Indirect emission white LED (only in combination with
direct controlled emission).

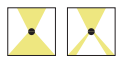
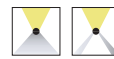
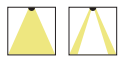

Diffused or dark light fluorescent direct emission.
Direct emission white or RGB LED,
diffused or wall washer.
Indirect emission white LED (only in combination
with direct controlled emission).

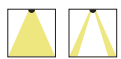

Diffused or dark light fluorescent emission.
Direct emission white or RGB LED, diffused.
Direct emission white LED, controlled and prismatic.

Algoritmo Floor

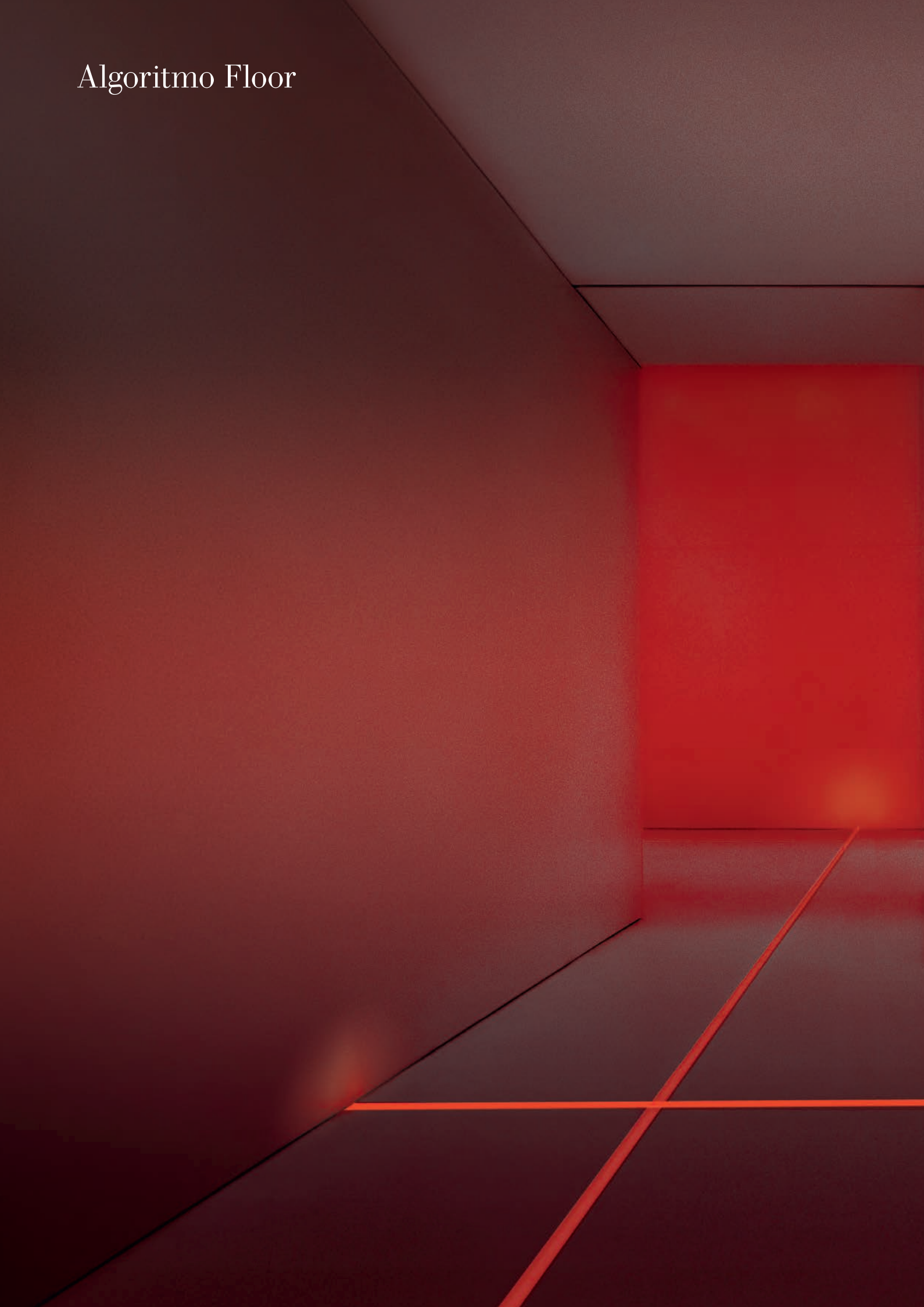

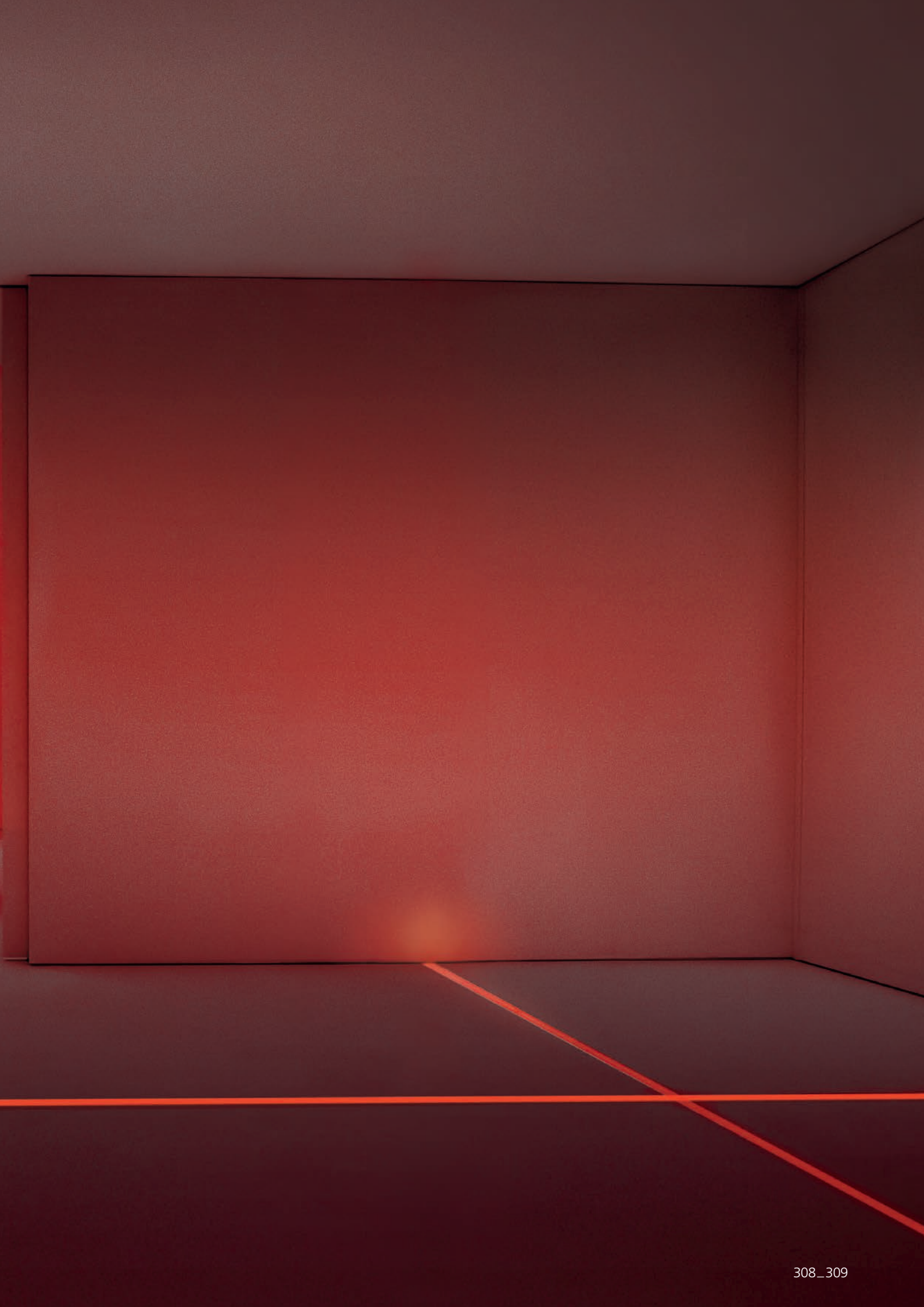

Algoritmo Floor Components

Recessing profile

+

- Algoritmo floor is a floor recessed-mounted LED lighting system designed to create narrow, light lines.
- Ideal to structure spaces, draw borders within architecture or create orientation lighting.
- IP67. Available only for indoor use.
- System including RGB LED body lamps, available as monochromatic warm or neutral white, and a recessing profile.
- The extremely compact dimensions allow a minimal visual impact on the architecture.
- Light fitting in extruded aluminium with anodised finish, sealed by an 8-mm thick diffuser in tempered glass.
- Available in 3 lengths: 600 mm, 900 mm, 1200 mm.
- Power supply and light management system to be ordered separately.
- Recessing profile in extruded aluminium to be ordered separately.
- Available in two lengths (1300 and 4900 mm), to be cut on site to the required configuration.
- Static load resistance: 5000 n.
- Lighting unit provided with quick-connector system for easy bridging connection.
- A proprietary low tension bus enables long distances to be covered without additional electrical supply.
- Not suitable for wall or ceiling installation.
- Complies with standard EN60598-1 and other specific standards.



Recessing profile in extruded aluminium. To be cut on site to the required dimension. Length 1300 mm Length 4900 mm

Body lamp

Casing in extruded aluminium

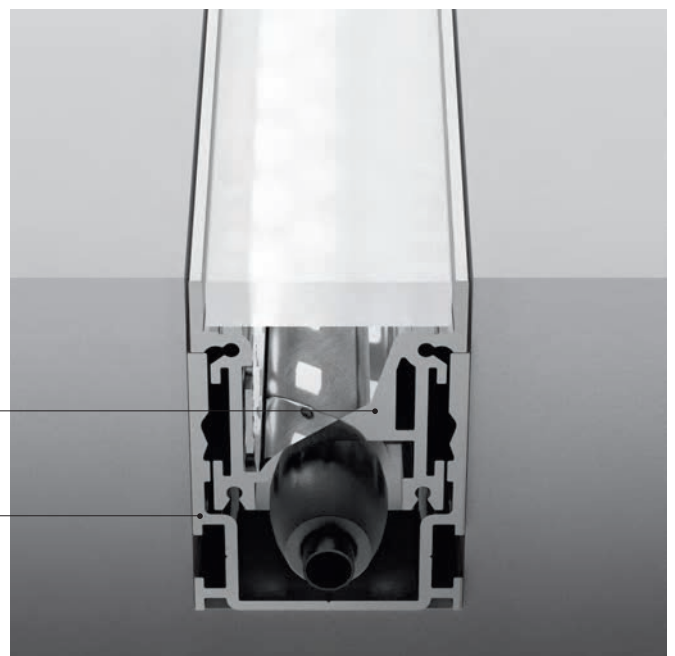

Recessing components

+

Body lamps

+

**Cables
Electrical components**

**Power supplies
and control systems**



End caps (set of 2).



White LED body lamp.
LV integrated
through-wiring.



RGB LED body lamp.
LV integrated
through-wiring.



Power supply cable set.
Consists of one power
supply cable (3x0.75mm²) + 1
blanking plug for sealing the
last luminaire of the row.



Electronic power supply
IP67.



Fixing brackets (set of 4).



Extension cable
3x 0.75 mm².



Control interface:
IP20 and IP67.
Allows management
of multiple RGB (LV) Algoritmo
System and/or Algoritmo Floor.



Straight mechanical
connector (set of 2).



Electrical connector*
for coupling wall-surface
mounted LED modules
of ALGORITMO SYSTEM LED
RGB with floor-recessed mo-
dules of ALGORITMO FLOOR,
powered through the same
shared electrical circuit*
Only for RGB LED.

Algoritmo Floor Installation

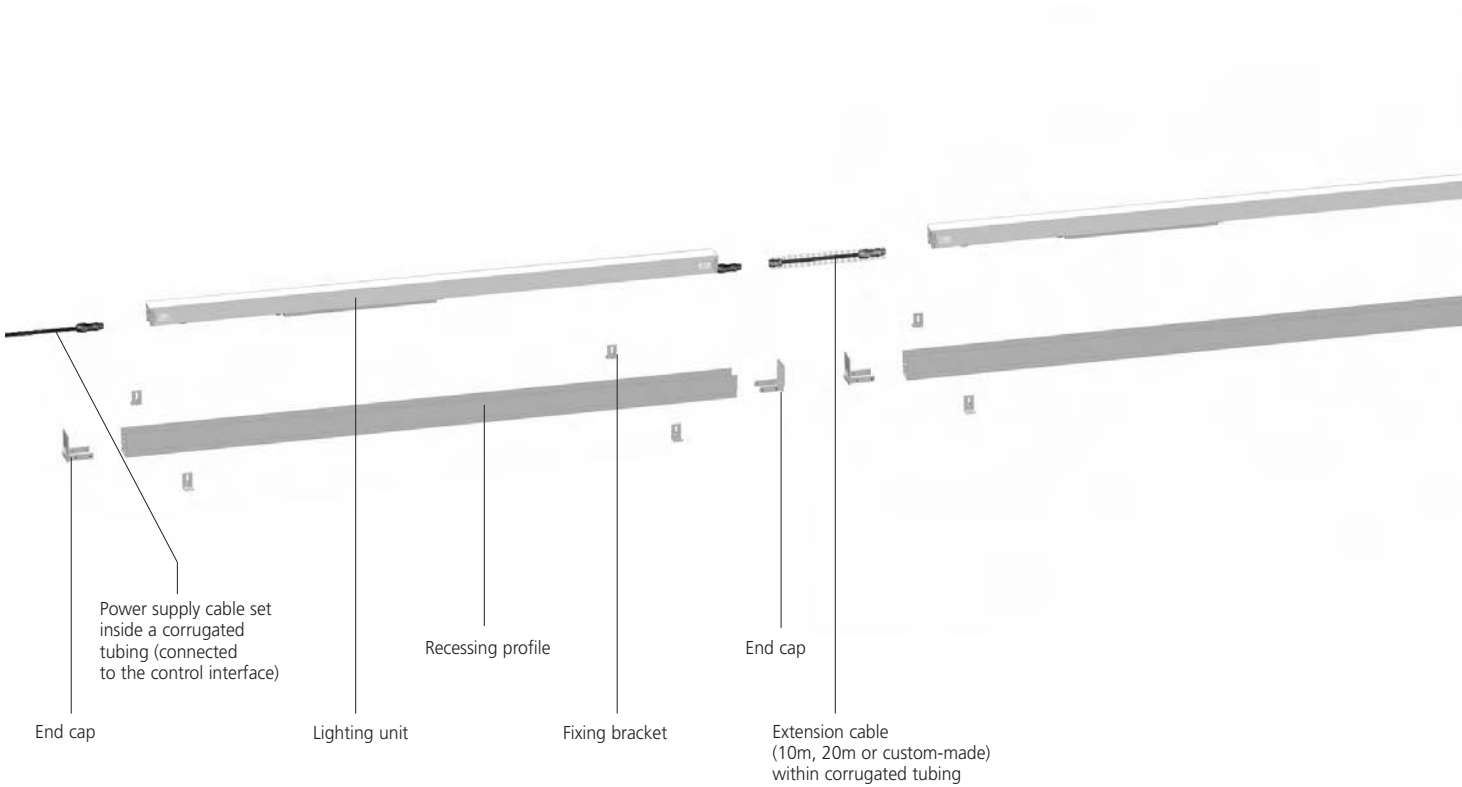

Single lighting units, or the lighting units starting and ending a row can be 900 or 1200 mm, but never 600 mm.



 ~~600 mm~~
900 mm
1200 mm



 ~~600 mm~~
900 mm
1200 mm

600 mm
900 mm
1200 mm

600 mm
900 mm
1200 mm

600 mm
900 mm
1200 mm

 ~~600 mm~~
900 mm
1200 mm

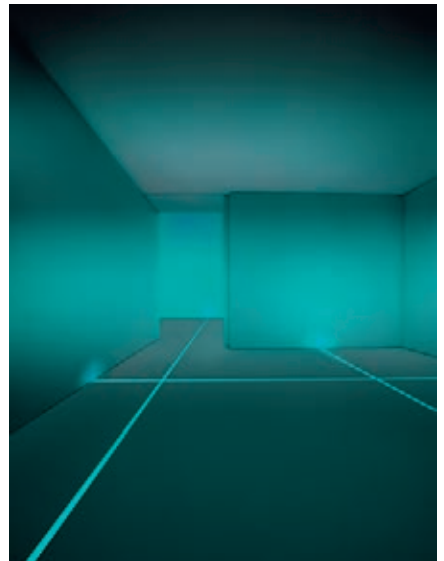
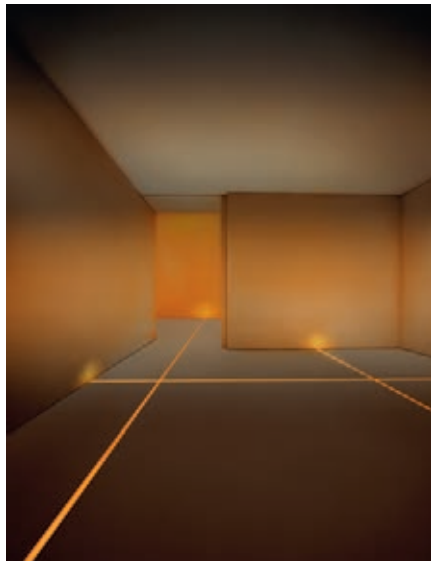
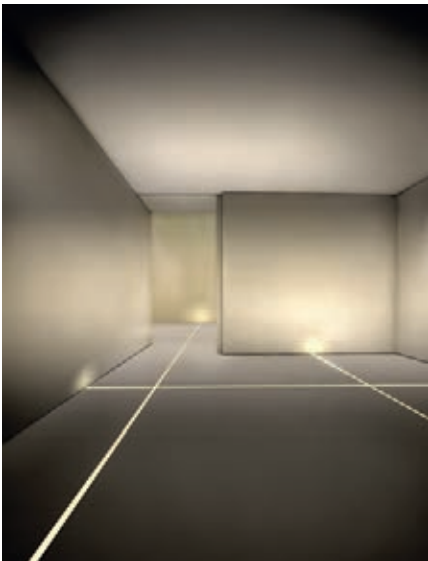
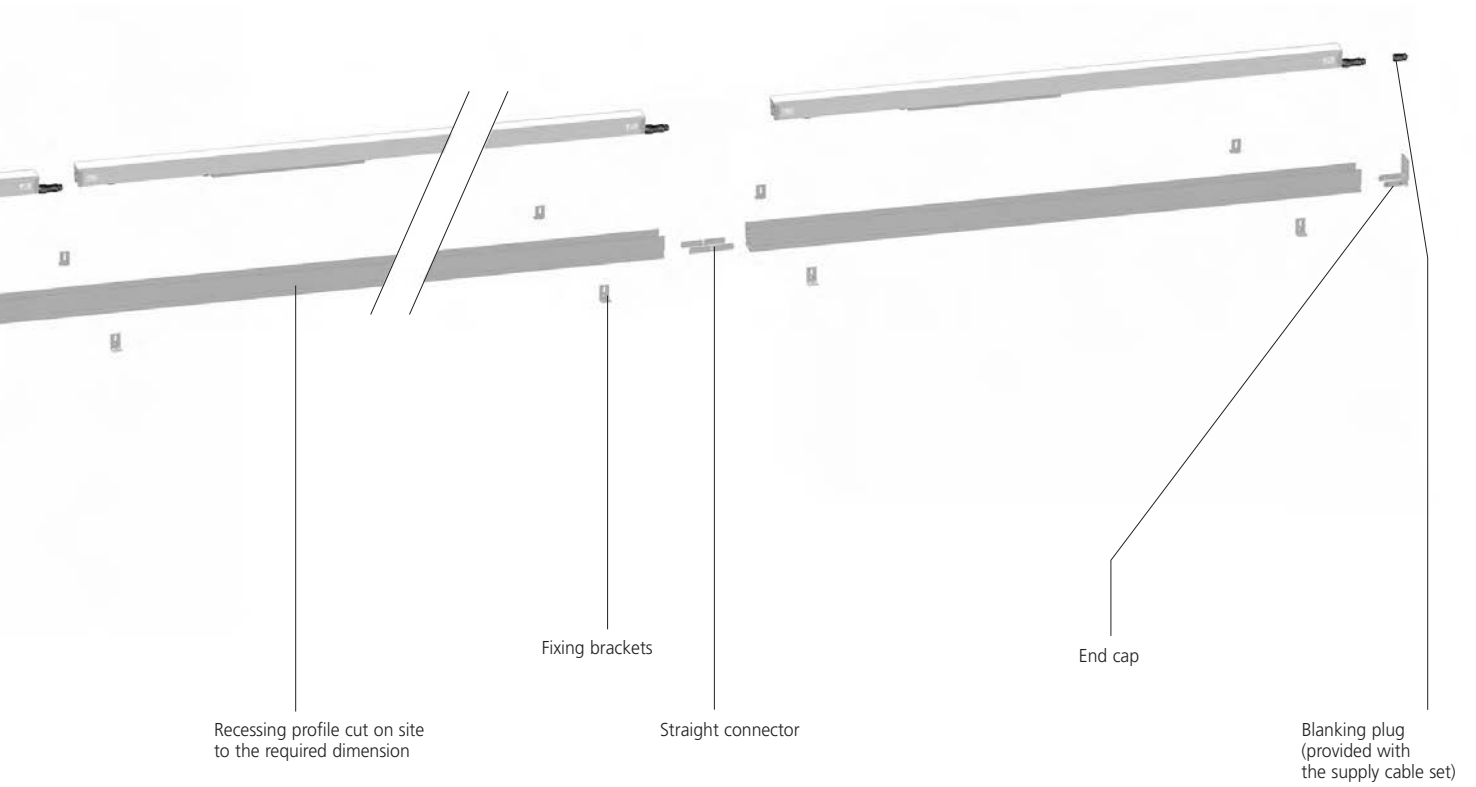

Algoritmo Floor white LED

Recessing unit

Length

1300 mm

4900 mm

Code

M221000

M221100

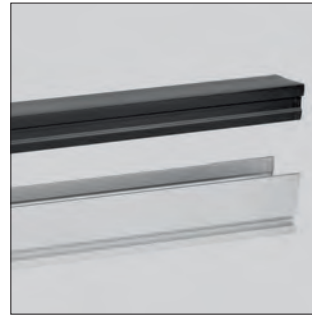

Can be custom cut



Body lamp

LED White

W (LED)	Length	Weight	Flux	CCT	Code
5 W	600 mm	1,30 kg	78 lm	3000 K	M220300
		1,30 kg	85 lm	4000 K	M220400
7,5 W	900 mm	1,90 kg	103 lm	3000 K	M220500
		1,90 kg	113 lm	4000 K	M220600
10 W	1200 mm	2,50 kg	155 lm	3000 K	M220700
		2,50 kg	170 lm	4000 K	M220800

LV integrated through-wiring.

Power supply and light management system to be ordered separately.



IP67 IK08

850°



Maximum load 5000N

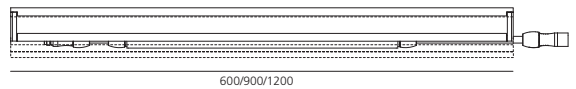
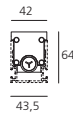

Algoritmo Floor Led

LED direct

luminaire direct

9 W

	10 W	10 W	10 W	10 W
Power	10 W	10 W	10 W	10 W
Flux	720 lm	780 lm	155 lm	170 lm
CCT	3000 K	4000 K	3000 K	4000 K
CRI	=80 (typ.)			
Color tolerance	MacAdam 4SDCM			
Service life	L70(6K) > 36000h			
Efficiency			22%	22%
Efficacy	72 lm/W	78 lm/W	15 lm/W	17 lm/W

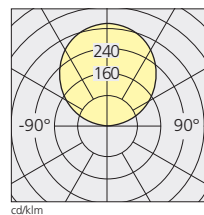

Values for luminaire body L 1200 mm.

Body lamp

LED RGB

W(LED)	Length	Weight	Code
9 W	600 mm	1,30 kg	M220000
13,5 W	900 mm	1,90 kg	M220100
18 W	1200 mm	2,50 kg	M220200

LV integrated through-wiring.

Power supply and light management system to be ordered separately.



IP67 IK08

850°



Maximum load 5000N

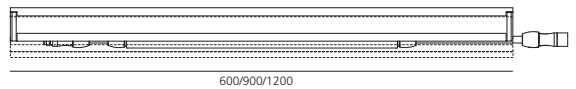
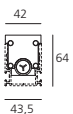

Power supply / light management system for LED



Electronic power supply
IP67.
Input voltage range:
90-264VAC / 47-63 VDC.
Output voltage: 48 VDC. Protection
against overcurrent, overvoltage,
short-circuit and overtemperature,
with automatic restart.

100 W
To supply up to a total 90 W.
220x68x38 mm.

240 W
To supply up to a total 225 W.
244x68x39 mm.

320 W
To supply up to a total 300 W.
252x90x44 mm.

Code

M075000

M075100

M076100



Control interface
For managing groups
of Algoritmo System
and/or Algoritmo Floor lighting units.
Integrated sequencer for stand-alone
operation with predefined colour
sequence. Possibility of master-slave
configuration.

IP67



DALI or DMX light management
systems are not included.

IP20

IP67. Compatible DALI-Switch Dimm
310x168x90 mm.

IP67. Compatible DALI-Switch Dimm
or DMX.
310x168x90 mm.

IP20. Compatible DALI-Switch Dimm
Suitable for DIN rail mounting.
106x90x70 mm.

IP20. Compatible DALI-Switch Dimm
or DMX.
Suitable for DIN rail mounting.
106x90x70 mm.

Code

M077000

M077100

M077200

M077300

For electrical diagram, please see page 346

Connection components and formwork finish



End cap (set of 2)
in aluminium.



Fixing bracket (set of 4)
in stainless steel.
Can slide along the profile.
Height adjustment ranging 22mm.



Straight mechanical connector
(set of 2) in stainless steel.
For the mechanical connection
of the recessing profiles.

Code

M221300

M221400

M221500

Electrical components



Power supply cable set.
Consists of one 5m-long power
supply cable (3x0,75mm²) to connect
the first luminaire to the control inter-
face, + 1 blanking plug to seal the last
luminaire of the row.

Length 5m.

Length 10m.

Length 15m.

Code

M221600

M222000

M222100



Extension cable
3x0,75mm².

Length 10m.

Length 20m.

M221700

M221800



Electrical connector
To couple wall-surface and wall-
recessed mounted led modules of
algoritmo system LED RGB (lv) with
floor-recessed modules of algoritmo
floor (lv), powered through the same
shared electrical circuit.

M221900

Algoritmo System







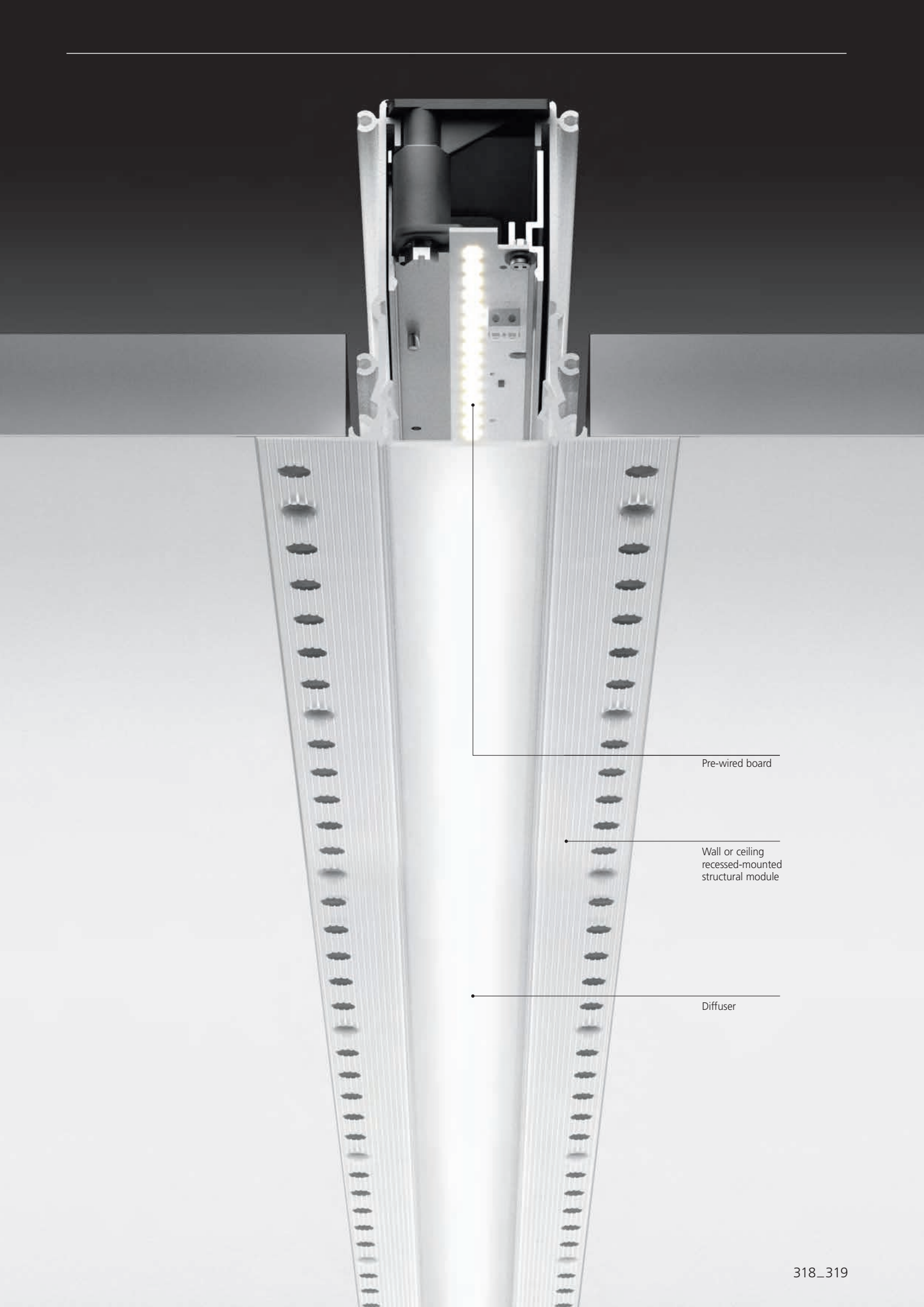

Pre-wired board

Wall or ceiling
recessed-mounted
structural module

Diffuser







Algoritmo System recessed wall/ceiling Components

Structural module



- Wall- or ceiling- recessed mounted modular system.
- Algoritmo system is particularly flexible; it allows different lighting solutions to be coupled through the same shared electrical system. Fluorescent diffused or dark light version, LED diffused or wall washer in warm (3000 K) or neutral white (4000 K), RGB LED, LED controlled and prismoptic, accent lighting.
- Installation in line or at a 90° angle.
- Algoritmo system is composed of:
- Structural modules in extruded aluminium, available in different lengths depending on the installation option and 2 finishes, white or gloss anodised.
- Gear plates with through-wiring and rapid connectors.
- Supplementary through-wiring with rapid connection.
- Optical systems: diffusers, dark light optics for fluorescent version, controlled optics for LED, wall washer optics for led, 3 white led monochromatic projectors (pad, pad square and 37 cube).
- End caps and joints.
- Supplying cables.
- Pre-cabled white LED (MV) plates equipped with electronic or electronic dimmerable driver (Dali-Switchdim). Pre-cabled RGB LED (LV) plates.
- Fluorescent gear plates with electronic or 'multiwatt' dimmable electronic supplier 28/54w (Dali-SwitchDim). T16 seamless tubes to be ordered separately.
- Power supply and led management systems (LV) to be ordered separately.
- Compliant with standard EN60598-1 and other specific standards.

Structural module for ceiling- or wall-recessed installation. Trimless finish, where installation requires a finish coat of plaster. End caps, angles, gear plates and optics unit available separately.

+	Junction components	+	Pre-wired gear plates	+
	 <p>End caps.</p>		 <p>Pre-wired gear tray for white LED diffused and wall washer. MV through-wiring included.</p>	 <p>Pre-wired gear tray for fluorescent tubes T16-SLS. MV through-wiring included.</p>
	 <p>90° angle to connect two recessed modules on the same plane.</p>		 <p>Pre-wired gear tray for RGB LED diffused. LV through-wiring included.</p>	
			 <p>Pre-wired gear tray for white LED dark light. MV through-wiring included.</p>	
			 <p>Pre-wired gear tray for accent lighting unit. PAD, PAD square and 37 Cube to be ordered separately. MV through-wiring included.</p>	

Electrical Components

+

Optical systems

+

Junction components

+

Spotlights

+

Power supplies and control systems



Optional through-wiring. To be used with mixed installations combining LV and MV pre-wired gear trays.

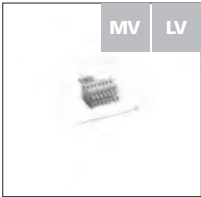

Power supply kit.



Electrical connector* to couple Algoritmo LED System (LV) with wall- and floor- recessed modules of Algoritmo Floor (LV), powered through the same shared electrical circuit.
*Only for RGB LED

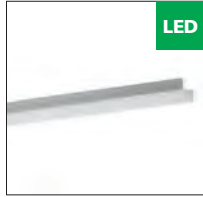

Opal polycarbonate diffuser for white LED and diffused RGB versions.



Controlled Optics for white LED version.



Prismoptics optics for white LED versions.



Polycarbonate optics for white LED wall washer versions.



Dark Light optics for fluorescent versions.



PMAA opal diffuser for fluorescent versions.



Junction to be fitted to the module on the same plane. Compatible with the junction for the same plane.



37 Cube for Algoritmo System.



PAD for Algoritmo System.



PAD Square for Algoritmo System.



Electronic power supply IP67.



Control interface: IP20 and IP67. Allows management of multiple (LV) Algoritmo System and/or Algoritmo Floor.













Algoritmo system wall/ceiling/suspension Components

Structural module



- Wall-mounted or ceiling-mounted modular system.
- Algoritmo system is particularly flexible; it allows different lighting solutions to be coupled through the same shared electrical system. Fluorescent diffused or dark light version, LED diffused or wall washer in warm (3000 K) or neutral white (4000 K), RGB LED, LED controlled and prismoptic, accent lighting.
- Installation in line or at a 90° angle.
- Algoritmo system consists of:
 - Structural modules in extruded aluminium, available in different lengths depending on the installation option and 2 finishes, white or gloss anodised.
 - Pre-wired gear trays and quick lock connectors. Supplementary through-wiring with quick lock connectors.
 - Optical systems: diffusers, dark light grille for fluorescent lights, prismoptic and controlled optics for LED, wall washer optics for LED, 3 LED white monochromatic projectors (PAD, PAD Square, 37 Cube).
- End caps and connectors.
- Supplying cables.
- Pre-cabled white LED (MV) plates equipped with electronic or electronic dimmerable driver (Dali-Switchdim). Pre-cabled RGB LED (LV) plates.
- Fluorescent plates with electronic or 'multiwatt' 28/54 W electronic dimming supplier (Dali-SwitchDim). T16-Seamless fluorescent tubes to be purchased separately.
- Compliant with standard EN60598-1 and other specific standards.

Structural module for wall, ceiling or suspended installation. End caps, angles, fixing components, electric plates and optics to be ordered separately.

+	Fixing components	+	Junction components	+	Pre-wired gear plates
	 <p>Wall bracket to connect a suspended module to the wall.</p>		 <p>End caps. (set of 2)</p>		 <p>MV LED</p>
	 <p>Wall / ceiling fixing bracket.</p>		 <p>Linear connector.</p>		 <p>LV+MV LV LED</p>
	 <p>Suspension cable (no supply).</p>		 <p>90° angle for the mechanical connection of two recessed modules on one same plane.</p>		 <p>MV LED</p>
	 <p>Suspension kit with supply. MV LV</p>		 <p>90° angle. For the mechanical connection of 2 modules on two perpendicular planes.</p>		 <p>MV LED</p>
					 <p>MV</p>

Electrical Components

+

Optical systems

+

Junction components

+

Spotlights

+

Power supplies and control systems



Optional through-wiring. To be used with mixed installations combining LV and MV pre-wired gear trays.

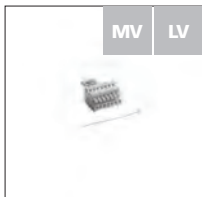

Power supply kit.



Electrical connector* to couple Algoritmo LED System (LV) with wall- and floor- recessed modules of Algoritmo Floor (LV), powered through the same shared electrical circuit.
*Only for RGB LED

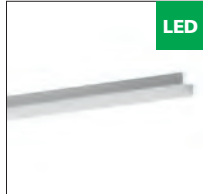

Opal polycarbonate diffuser for white LED and diffused RGB versions.



Dark Light Optics for white LED versions.



Prismoptics optics for white LED versions.



Polycarbonate optics for white LED wall washer versions.



Dark Light optics for fluorescent versions.



PMAA opal diffuser for fluorescent versions.



Junction to be fitted to the module on the same plane. Compatible with the junction for the same plane.



2-plane joint to be clipped to the module. Compatible with connectors for 2 modules on perpendicular planes.



37 Cube for Algoritmo System.



PAD for Algoritmo System.



PAD Square for Algoritmo System.



Electronic power supply IP67.



Control interface: IP20 and IP67. Allows management of multiple (LV) Algoritmo System and/or Algoritmo Floor.

Structural module

Length	Weight	Color	Code
1184 mm	1,80 kg	●	M204800
2368 mm	3,60 kg	●	M204900



62x(ΣL+10 mm)

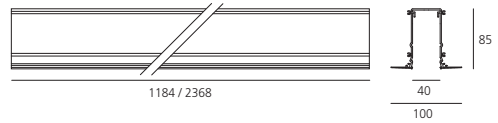

Accessories



90° angle
to mechanically connect two recessed modules on the same plane.

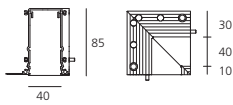

Code
M196600



End caps
(set of 2)

Code
M197300

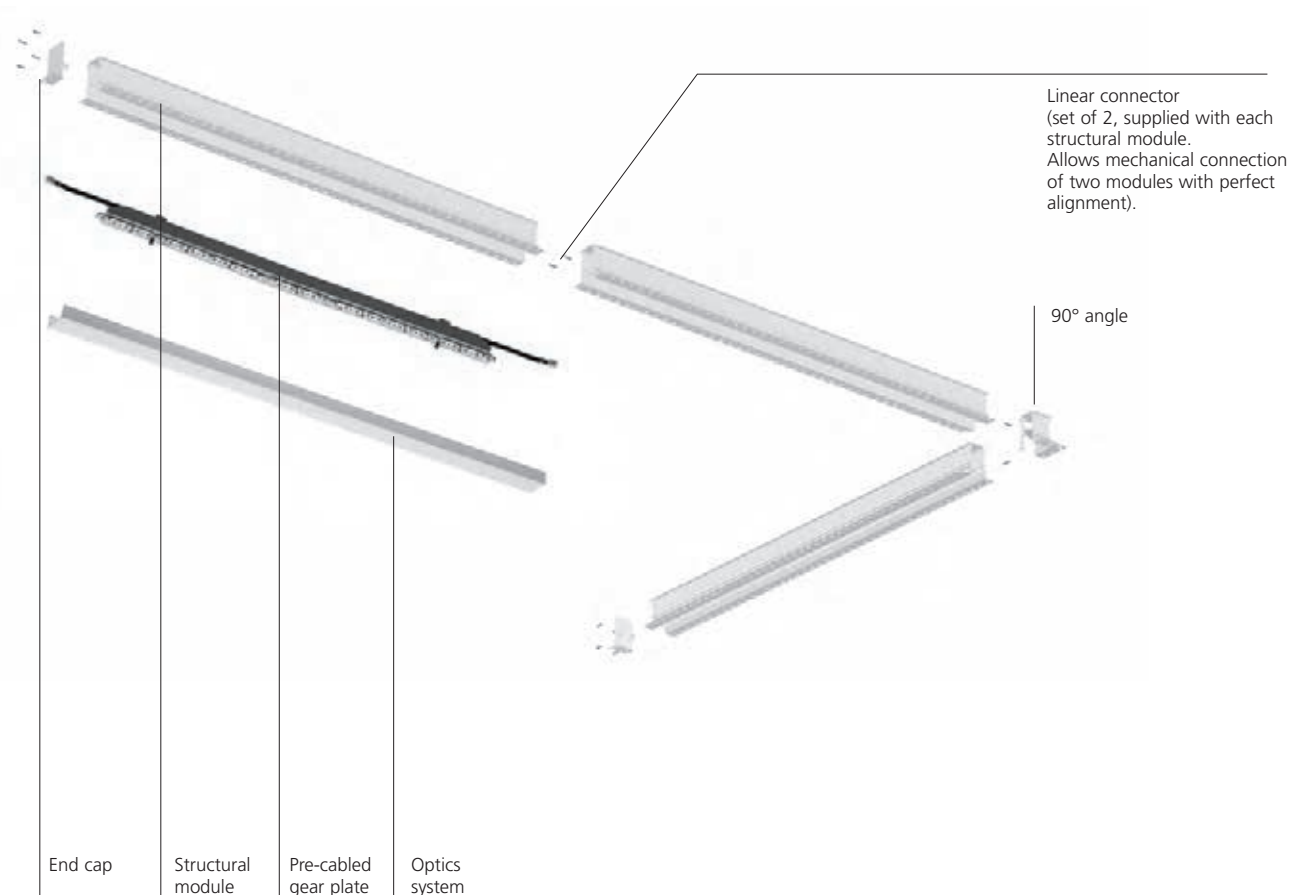



Ristorante L'arte - Milano (Italy), Interior project: Lorenzo Morganti, Grixoni Service, Photo: Federico Villa

Structural module

Length	Weight	Color	Code
1184 mm	2,30 kg	○	M205020
		●	M205060
2368 mm	4,60 kg	○	M205120
		●	M205160
3552 mm	6,90 kg	○	M206320
		●	M206360
4736 mm	9,20 kg	○	M199520
		●	M199560

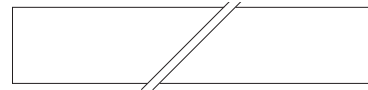

1184/2368/3552/4736

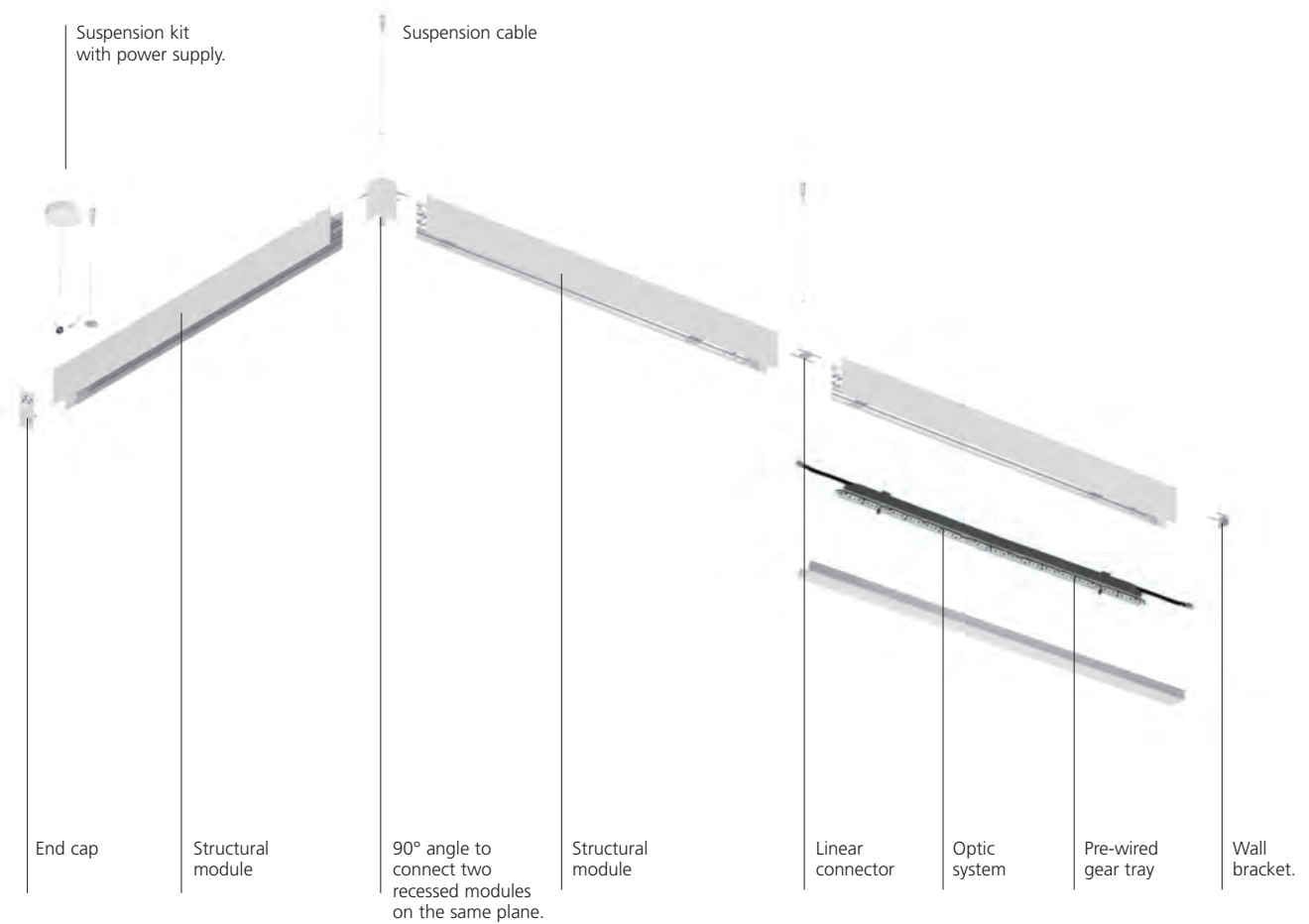
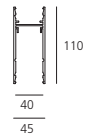

White Gloss anodised

Accessories



90° angle
To mechanically connect two recessed modules on one same plane. 0.30 kg.

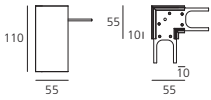

Color

Code
M196820
M196860

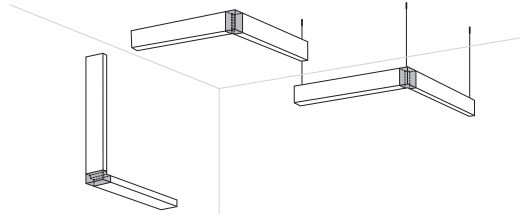

90° angle
To mechanically connect of 2 modules on one same plane. Includes through-wire extensions. 0.60 kg.

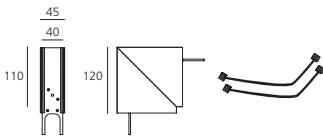

M196720
M196760

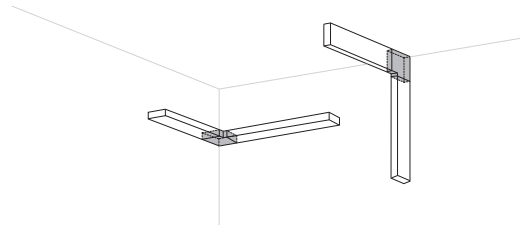

Wall bracket
To mechanically connect a wall-mounted module.

M199300

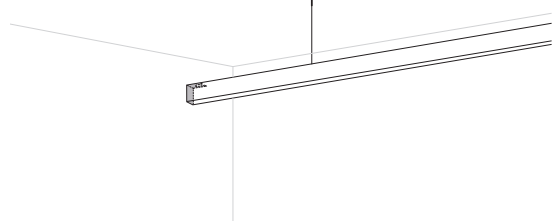

End caps
(set of 2)

M188820
M188860



Linear connector

M189000



Bracket for fixing to wall/ceiling
(1 piece)

M199400

Length of a single module	no. pieces required for each module
1184 mm	2
2368 mm	2
3552mm	3
4736mm	4

Applicable also for system installations.



Steel suspension cable with quick adjustment
Length 2 meters

M189100

Length of a single module	no. pieces required for each module
1184 mm	2
2368 mm	2
3552mm	2
4736mm	3

Please check on Artemide.com for continuous system installations with 2+ connected modules.



Suspension kit with power supply.
Includes 1 single steel suspension cable + 1 power supply cable
Length 2 meters

LV (3x1,5mm²)
For supplying LED modules RGB.

M189200

MV (5x1,5mm²+2x0,5mm²)
To power fluorescent modules, white LED plates and accent modules.

M189300





Atelier Era - Cavalon veronese (Italy), Arch: Alberto Salvadori, Photo: Marco Zaffa

Algoritmo System diffused emission

Wired gear plates

White LED direct emission

W	Length	Weight	CCT
23 W	1184 mm	1,10 kg	3000 K 4000 K
46 W	2368 mm	2,00 kg	3000 K 4000 K

non dimmable

Code
M146200
M146300
M146400
M146500

Dali-SwitchDim

Code
M146201
M146301
M146401
M146501

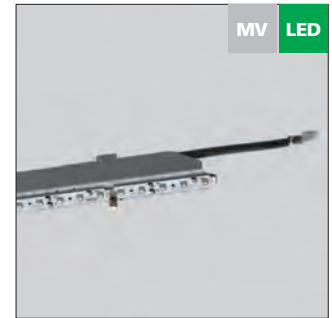

MV integrated through-wiring.

White LED with direct emission + fluo indirect

W	Length	Weight	CCT (LED)
23 W	1184 mm	1,10 kg	3000 K
1x39 W (T16 (G5))			4000 K
46 W	2368 mm	2,00 kg	3000 K
2x39 W (T16 (G5))			4000 K

non dimmable

Code
M151500
M151600
M151700
M151800

Dali-SwitchDim*

Code
M151501
M151601
M151701
M151801



650°

* Only direct emission is dimmable.

MV integrated through-cable.
Upper screen in PMMA included.

Algoritmo System diffused emission

Diffuser

Opal diffuser in polycarbonate for LED plates

Length	Weight
1184 mm	0,10 kg
2368 mm	0,20 kg
3552 mm	0,30 kg
4736 mm	0,40 kg

Code

M197400
M186800
M203800
M197500

Not suitable for Fluo version.



850°

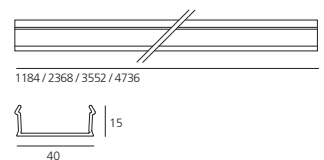

Algoritmo white LED

LED	luminaire			
	20 W	20 W	23 W	23 W
Power	20 W	20 W	23 W	23 W
Flux	2550 lm	2729 lm	1213 lm	1303 lm
CCT	3000 K	4000 K	3000 K	4000 K
CRI	=80 (typ.)			
Color tolerance	MacAdam 3SDCM			
Service life	L70(6K) > 50000h			
Efficiency			48%	48%
Efficacy	128 lm/W	136 lm/W	53 lm/W	57 lm/W

Values for luminaire body L 1184 mm.

23 W

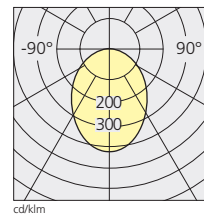

Indirect T16 (G5)

39 W 3100 lm

Efficiency 54%

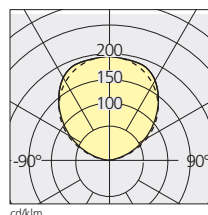

Algoritmo System diffused emission

Wired gear plates

FLUO T16-SLS (G5)

W	Length	Weight
1x54 W	1184 mm	1,10 kg
2x54 W	2368 mm	2,00 kg
1x28-54 W	1184 mm	1,10 kg
2x28-54 W	2368 mm	2,00 kg

non dimmable

Code
M204000
M204200

Dali-SwitchDim

Code
M204001
M204201



MV integrated through-cable.

FLUO T16-SLS (G5) direct emission + T16 (G5) indirect emission

W	Length	Weight
1x54 W (T16-SLS (G5)) + 1x39 W (T16 (G5))	1184 mm	1,10 kg
2x54 W (T16-SLS (G5)) + 2x39 W (T16 (G5))	2368 mm	2,00 kg
1x28-54 W (T16-SLS (G5)) + 1x39 W (T16 (G5))	1184 mm	1,10 kg
2x28-54 W (T16-SLS (G5)) + 2x39 W (T16 (G5))	2368 mm	2,00 kg

non dimmable

Code
M204100
M204300

Dali-SwitchDim*

Code
M204101
M204301



650°

* Only direct emission is dimmable.
MV through-wiring included.
Upper screen in PMMA included.

Algoritmo System diffused emission

Diffuser

Opal diffuser in PMMA for FLUO plates

Length	Weight
1184 mm	0,10 kg
2368 mm	0,20 kg
3552 mm	0,30 kg
4736 mm	0,40 kg

Code
M188100
M188200
M203700
M197800



T16-SLS (G5)

28/54 W 2600/4450 lm

Efficiency 56%

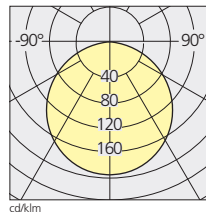

Indirect T16 (G5)

39 W 3100 lm

Efficiency 54%

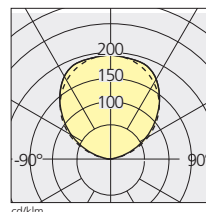

650°

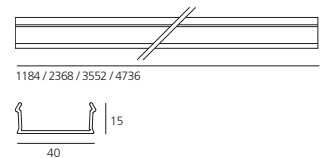

Values for luminaire body L 1184 mm.

Algoritmo System LED Controlled Emission

Patent pending (IT) n° MI2013A001711



Controlled emission LED optic System UGR index control and 65° luminance (EN 12464)

Patent-pending proprietary optic system made by a thin black square-meshed grid and by a system of square plano-convex lenses of appropriate beam angle. The internal part of the grid is white painted and has a high reflection coefficient, so that the light incident on the grid is retrieved within the Algoritmo body.

A net 'cut off' at the required angle is obtained through this system.

The convex profile of the lens is designed with images optic techniques, so that the emission is limited within the 65° required by standard EN 12464.

UGR < 19

Angle luminance equals to 65° and beyond:
< 3,000 cd/m².

Operating diagram of the optical device used on Algoritmo:

The grid positioned over the lenses allows only the rays falling into the required output angular limits to be incident to the lenses.

The rays beyond these limits are recovered and redirected inside the light box (if the ray is incident to the white surface) or cancelled (if the ray is incident to the black edge).

Functioning scheme

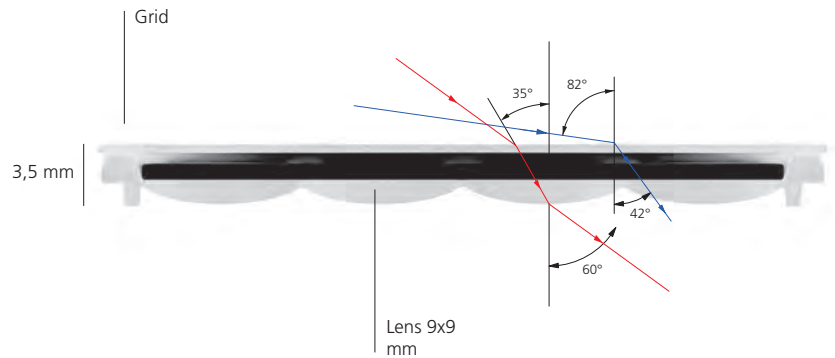

light ON

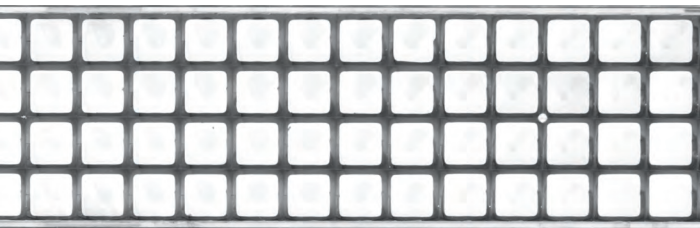

light OFF

UGR < 19	3000 K	4000 K
E ₀ (h 1m)	858 lux	918 lux
E ₀ (h 2m)	215 lux	230lux
	C0-C180	C0-C180
	79°	79°
	C90-C270	C90-C270
	93°	93°

Algoritmo system controlled emission

Wired gear plates

White LED direct emission

W	Length	Weight	CCT
34 W	1184 mm	1,10 kg	3000 K 4000 K
68 W	2368 mm	2,00 kg	3000 K 4000 K

MV integrated through-cable.

non dimmable

Code
M2882W00
M2882N00
M2884W00
M2884N00

Dali-SwitchDim

Code
M2882W01
M2882N01
M2884W01
M2884N01



White LED direct emission + indirect LED

W	Length	Weight	CCT (LED)
34 W +	1184 mm	1,10 kg	3000 K 4000 K
68 W +	2368 mm	2,00 kg	3000 K 4000 K

MV integrated through-cable.

* Direct e indirect emission dimmable

Protection screen for indirect cabled LED plate included.

Occupies 2 Dali destination

non dimmable

Code
M2883W00
M2883N00
M2885W00
M2885N00

Dali-SwitchDim*

Code
M2883W01
M2883N01
M2885W01
M2885N01



650°

Patent pending (IT) n° MI2013A001711

Optics

Optics kit for controlled emission

Length	Weight
1184 mm	0,20 kg
2368 mm	0,40 kg

Code
M186700
M187300

Not suitable for Fluo version.



850°

Algoritmo white LED

LED	luminaire	
29 W	29 W	34 W
3361 lm	3596 lm	1493 lm
3000 K	4000 K	3000 K
3000 K	4000 K	4000 K
≈80 (typ.)		
MacAdam 4SDCM		
L70(9K) > 50000h		
	C0-C180	C0-C180
	79°	79°
	C90-C270	C90-C270
	93°	93°
	45%	45%
116 lm/W	124 lm/W	44 lm/W
		47 lm/W

34 W

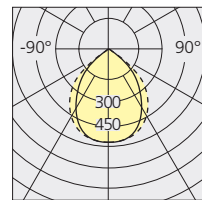

cd/klm
 — C0 - C180
 C90 - C270

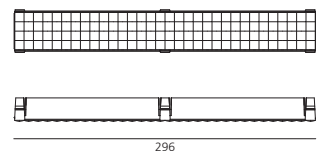

296

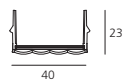

40

Values for luminaire body L 1184 mm.

Algoritmo white LED

LED	luminaire	
27 W	27 W	30 W
4240 lm	4400 lm	3307 lm
3000 K	4000 K	3000 K
3000 K	4000 K	4000 K
≈80 (typ.)		
MacAdam 4SDCM		
L70(9K) > 50000h		
		78%
		78%
157 lm/W	163 lm/W	110 lm/W
		114 lm/W

30 W

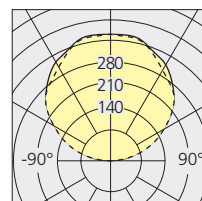

cd/klm

Values for luminaire body L 1184 mm.

Algorithmo System controlled emission

Wired gear plates

White LED direct emission

W	Length	Weight	CCT
23 W	1184 mm	1,10 kg	3000 K 4000 K
46 W	2368 mm	2,00 kg	3000 K 4000 K

non dimmable

Code
M146200
M146300
M146400
M146500

Dali-SwitchDim

Code
M146201
M146301
M146401
M146501



MV integrated through-wiring.

White LED with direct emission + fluo indirect

W	Length	Weight	CCT (LED)
23 W	1184 mm	1,10 kg	3000 K
1x39 W (T16 (G5))			4000 K
46 W	2368 mm	2,00 kg	3000 K
2x39 W (T16 (G5))			4000 K

non dimmable

Code
M151500
M151600
M151700
M151800

Dali-SwitchDim*

Code
M151501
M151601
M151701
M151801

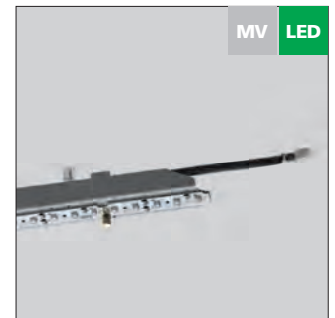

650°

* Only direct emission is dimmable.

MV integrated through-cable.
Upper screen in PMMA included.

Algorithmo System controlled emission

Optics

controlled emission optics for LED plates

Length	Weight	Code
1184 mm	0,20 kg	M196900
2368 mm	0,40 kg	M197000

Not suitable for Fluo version.



850°

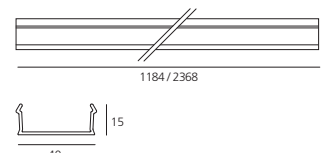

Algorithmo white LED

LED	luminaire			
	20 W	20 W	23 W	23 W
Flux	2550 lm	2729 lm	1402 lm	1520 lm
CCT	3000 K	4000 K	3000 K	4000 K
CRI	=80 (typ.)			
Color tolerance	MacAdam 3SDCM			
Service life	L70(9K) > 50000h			
Beam			C0-C180 73°	C0-C180 73°
			C90-C270 115°	C90-C270 115°
Efficiency			55%	55%
Efficacy	128 lm/W	136 lm/W	61 lm/W	66 lm/W

23 W

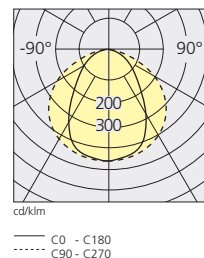

Values for luminaire body L 1184 mm.

23 W	3000 K				4000 K			
	H m	Ø m	EMax lux	EM lux	H m	Ø m	EMax lux	EM lux
	1	1,47	645	212	1	1,47	700	230
	2	2,94	161	53	2	2,94	175	57
	3	4,41	72	24	3	4,41	78	26
	4	5,87	40	13	4	5,87	44	14
	5	7,34	26	8	5	7,34	28	9

Indirect T16 (G5)

Efficiency 54%

39 W 3100 lm

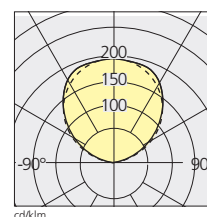

Algoritmo System dark light emission fluo

Wired gear plates

FLUO T16-SLS (G5) direct emission + T16 (G5) indirect emission

W	Length	Weight
1x54 W	1184 mm	1,10 kg
2x54 W	2368 mm	2,00 kg
1x28-54 W	1184 mm	1,10 kg
2x28-54 W	2368 mm	2,00 kg

MV integrated through-wiring.

non dimmable

Code
M204000
M204200

Dali-SwitchDim*

Code
M204001
M204201



⊖

W	Length	Weight
1x54 W + 1x39 W	1184 mm	1,10 kg
2x54 W + 2x39 W	2368 mm	2,00 kg
1x28-54 W + 1x39 W	1184 mm	1,10 kg
2x28-54 W + 2x39 W	2368 mm	2,00 kg

* Only direct emission is dimmable.

MV integrated through-cable.
Upper screen in PMMA included.

Code
M204100
M204300

Code
M204101
M204301



⊖

650°

Algoritmo System dark light emission

Optics

Dark light optics in metal polycarbonate

Length	Weight
1184 mm	0,20 kg
2368 mm	0,40 kg

Code
M188500
M188600

T16-SLS (G5)

Efficiency 33%

UGR < 19	2θ/2 = 85°	54 W	28 W
E ₀ (h 1m)	916 lux	531 lux	
E ₀ (h 2m)	229 lux	133 lux	

28/54 W 2600/4450 lm

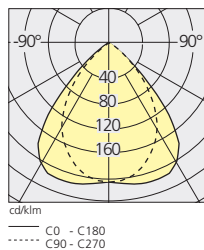

960°

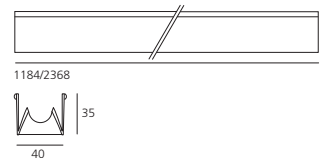

Algoritmo System wall washer emission

Wired gear plates

White LED direct emission

W	Length	Weight	CCT
23 W	1184 mm	1,10 kg	3000 K 4000 K
46 W	2368 mm	2,00 kg	3000 K 4000 K

MV integrated through-cable.

non dimmable

Code
M146200
M146300
M146400
M146500

Dali-SwitchDim

Code
M146201
M146301
M146401
M146501

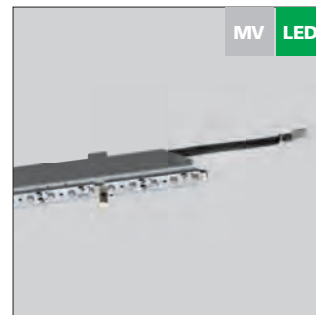

White LED wall washer direct emission + fluo indirect emission

W	Length	Weight	CCT (LED)
23 W	1184 mm	1,10 kg	3000 K
1x39 W (T16 (G5))			4000 K
46 W	2368 mm	2,00 kg	3000 K
2x39 W (T16 (G5))			4000 K

* Only direct emission is dimmable.

MV integrated through-cable.
Upper screen in PMMA included.

non dimmable

Code
M151500
M151600
M151700
M151800

Dali-SwitchDim*

Code
M151501
M151601
M151701
M151801

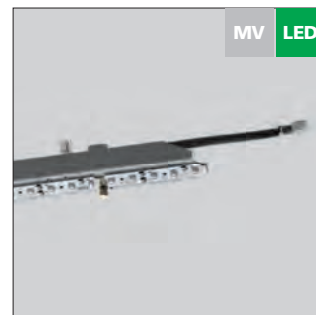

650°

Algoritmo System wall washer emission

Optics

Wall washer optics

Length	Weight
1184 mm	0,70 kg
2368 mm	1,40 kg

Not suitable for Fluo version.

Code
M217300
M217400



650°



1184 / 2368

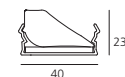

Algoritmo white LED

LED	luminaire			
Power	20 W	20 W	23 W	23 W
Flux	2500 lm	2750 lm	1331 lm	1461 lm
CCT	3000 K	4000 K	3000 K	4000 K
CRI	=80 (typ.)			
Color tolerance	MacAdam 4SDCM			
Service life	L70(6K) > 50000h			
Efficiency			53%	53%
Efficacy	128 lm/W	141 lm/W	68 lm/W	75 lm/W

Values for luminaire body L 1184 mm.

23 W

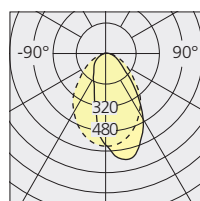

cd/klm
— C0 - C180
..... C90 - C270

39 W

3100 lm

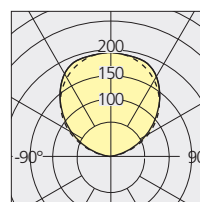

cd/klm

Indirect T16 (G5)

Efficiency 62%

Values for luminaire body L 1184 mm.



Atelier Esra - Casalon veronese (Italy), Arch.: Alberto Salvadori, Photo: Marco Zanatta

Algoritmo System RGB LED

Wired gear plates

RGB LED with diffused direct emission

W (LED)	Length	Weight
18 W	1184 mm	1,10 kg
36 W	2368 mm	2,00 kg

Code
M199600
M199700

LV integrated through-wiring.
Power supply and light management system to be ordered separately.

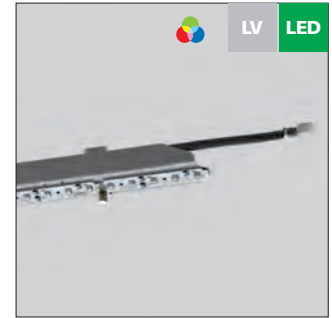

RGB LED diffused direct emission + fluorescent indirect

W	Length	Weight
18 W (LED)	1184 mm	1,10 kg
1x39 W (T16 (G5))		
36 W (LED)	2368 mm	2,00 kg
2x39 W (T16 (G5))		

Code
M199800
M199900

LV+MV integrated through-wiring.
Upper screen in PMMA included.
Power supply and light management system to be ordered separately.



650°

Algoritmo System suspension RGB LED

Optics

Opal diffuser in polycarbonate

Length	Weight
1184 mm	0,10 kg
2368 mm	0,20 kg
3552 mm	0,30 kg
4736 mm	0,40 kg

Code
M197400
M186800
M203800
M197500

Not suitable for Fluo version.

Indirect T16 (G5)

Efficiency 62%

39 W 3100 lm

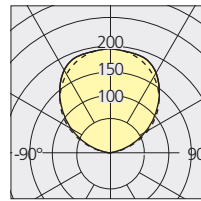

850°



1184 / 2368 / 3552 / 4736

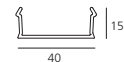

40

Power supply/light management system for LED*



Electronic power supply
IP67. Input voltage range:
90-264VAC / 47-63 VDC.
Output voltage: 48 VDC. Protection
against overcurrent, overvoltage,
short-circuit and overtemperature,
with automatic restart.

100 W
For voltage up to a total 90 W.
220x68x38 mm.

240 W
For voltage up to a total 225 W.
244x68x39 mm.

320 W
For voltage up to a total 300 W.
252x90x44 mm.

Code

M075000

M075100

M076100



Control interface
Control interface
For managing groups
of Algoritmo System LED RGB
and/or white LED/RGB Algoritmo
Floor lighting units.

IP67



Integrated sequencer for stand-alone
operation with predefined colour
sequence. Possibility of master-slave
configuration.
DALI or DMX light management
systems are not included.

IP20

IP67. Compatible DALI-Switch Dimm
310x168x90 mm.

IP67. Compatible DALI-Switch Dimm
or DMX.
310x168x90 mm.

IP20. Compatible DALI-Switch Dimm
Suitable for DIN rail mounting.
106x90x70 mm.

IP20. Compatible DALI-Switch Dimm
or DMX.
Suitable for DIN rail mounting.
106x90x70 mm.

M077000

M077100

M077200

M077300

For electrical diagram, please see page 346

Closure screens for 90° angles



**Junction to be fitted
to the module on the same plane**
Compatible with the junction
for the same plane.

For continuity between LED diffused
emission modules.

Code

M198100

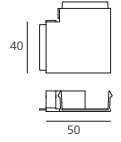

For continuity between dark light fluo emission,
LED emission modules and spot modules.

M198000

For continuity between wall-washer LED
emission modules.

M198200

For continuity between Fluo diffused emis-
sion modules.

M197900

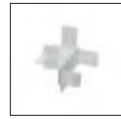

2-plane joint

To be clipped to the module.
Compatible with connectors for
2 modules on perpendicular planes.
For continuity between LED diffused emis-
sion modules.

M198500

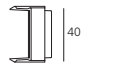

For continuity between dark light fluo emis-
sion, LED emission modules
and spot modules.

M198400

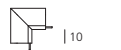

For continuity between wall-washer LED
emission modules.

M198600

For continuity between Fluo diffused emis-
sion modules.

M198300

Electrical components



Supplementary through-wiring
(optional).
To be used in mixed configuration
with LV and MV pre-cabled
gear trays.

LV 1184 mm
LV 2368 mm
MV 1184 mm
MV 2368 mm

Code

M198800

M199000

M198700

M198900



Electrical connector *
To couple wall-surface
or floor-recessed LED Algoritmo System
modules, powered through
the same electrical circuit.
* Only for RGB LED

M221900



Supply Kit
Allows for connection of the mains
to the first pre-wired gear plate
of the initial module. To be used only
with recessed and surface installation.

LV (3xmax 1,5 mm²)
To power LED RGB trays.

MV (7xmax 1,5 mm²)
To power fluorescent modules,
white LED plates and accent modules.

M073230

M073240

Light sources



**T16-SEAMLESS (G5)
fluorescent tube**

1 piece
28 W (3000 K)
28 W (4000 K)
54 W (3000 K)
54 W (4000 K)

Code

M004810

M004815

M004800

M004805



T16 (G5) fluorescent tube

1 piece
39 W (3000 K)
39 W (4000 K)

M004380

M004381

Algoritmo System for PAD projectors

Pre-wired gear tray for direct emission

Length	Weight
1184 mm	1,20 kg

Allows installation and supplying of 1-4 PAD 230V projectors.
MV through-wiring included.

Code
M217800



⊕
650°

Double emission version, with upper screen in PMMA. PAD projectors to be ordered separately.

PAD projectors to be ordered separately.

Pre-wired gear tray for direct + indirect emission

Length	Weight
1184 mm	1,20 kg

Allows installation and powering of 1-4 PAD 230V + indirect projectors T16 (G5) 1x39 W.
MV through-wiring included.

Code
M217900

Accessories



Blind panel, in polished metal grey steel.
1 piece required for each PAD empty position.

Code
M217760



Intermediate finishing cap (set of 2), in polished metal grey steel.
To be used at the junction of PAD modules with FLUO or LED modules.

M217660

Closure screens for 90° angles



Junction to be fitted to the module on the same plane
Compatible with the junction for the same plane.

For continuity between dark light fluo emission, LED emission modules and spot modules.

Code

M198000

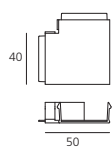

Electrical components



Supplementary through-wiring (optional).
To be used in mixed configuration with LV and MV pre-cabled gear trays.

LV	1184 mm
LV	2368 mm

Code

M198800
M199000



2-plane joint
To be clipped to the module. Compatible with connectors for 2 modules on perpendicular planes.

For continuity between dark light fluo emission, LED emission modules and spot modules.

Code

M198400

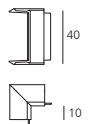

Supply Kit
Allows for connection of the mains to the first pre-wired gear plate of the initial module. To be used only with recessed and surface installation.

LV (3xmax 1,5 mm²)
For supplying LED RGB trays.

MV (7xmax 1,5 mm²)
To power fluorescent modules, white LED plates and accent modules.

M073230

M073240

Light sources



T16 (G5) fluorescent tube
1 piece

39 W (3000 K)
39 W (4000 K)

Code

M004380
M004381

Gloss anodised



LED						non dimmable	
W	Weight	Beam	Flux	CCT	Color	Code	
14,5 W	0,53 kg	12°	825 lm	3000 K	☉	M200002	
			880 lm	4000 K	☉	M200102	
		24°	825 lm	3000 K	☉	M200202	
			880 lm	4000 K	☉	M200302	
		36°	805 lm	3000 K	☉	M200402	
			855 lm	4000 K	☉	M200502	



IP40 ☉
650°

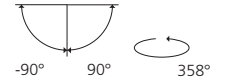

To be coupled with pre-wired gear plate.

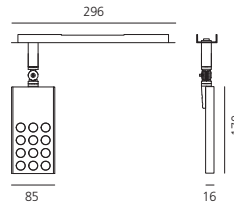

Pad 12°	LED		luminaire	
Power	12 W	12 W	14,5 W	14,5 W
Flux	994 lm	1060 lm	825 lm	880 lm
CCT	3000 K	4000 K	3000 K	4000 K
CRI	=80 (typ.)			
Color tolerance	MacAdam 4SDCM			
Service life	L70(14K) > 81600h			
Beam			12°	12°
Efficiency			83%	83%
Efficacy	82,8 lm/W	88,2 lm/W	56,8 lm/W	60,5 lm/W

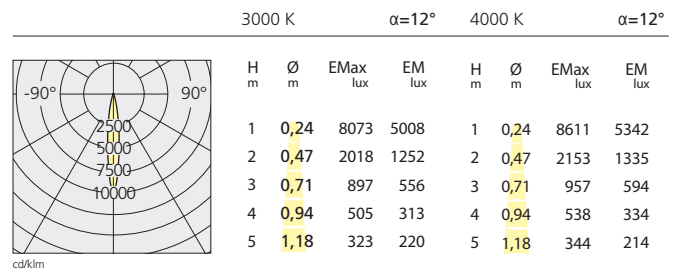

Pad 24°	LED		luminaire	
Power	12 W	12 W	14,5 W	14,5 W
Flux	994 lm	1060 lm	825 lm	880 lm
CCT	3000 K	4000 K	3000 K	4000 K
CRI	=80 (typ.)			
Color tolerance	MacAdam 4SDCM			
Service life	L70(14K) > 81600h			
Beam			24°	24°
Efficiency			83%	83%
Efficacy	82,8 lm/W	88,2 lm/W	56,9 lm/W	60,6 lm/W

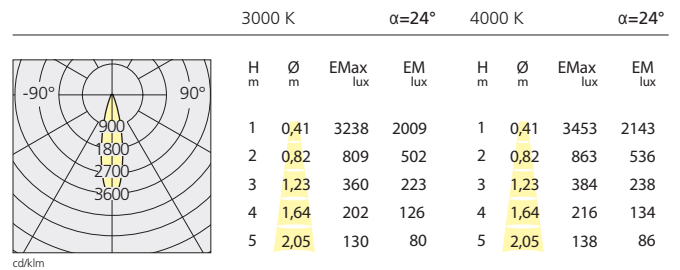

Pad 36°	LED		luminaire	
Power	12 W	12 W	14,5 W	14,5 W
Flux	994 lm	1060 lm	805 lm	855 lm
CCT	3000 K	4000 K	3000 K	4000 K
CRI	=80 (typ.)			
Color tolerance	MacAdam 4SDCM			
Service life	L70(14K) > 81600h			
Beam			36°	36°
Efficiency			81%	81%
Efficacy	82,8 lm/W	88,2 lm/W	55,5 lm/W	59,1 lm/W

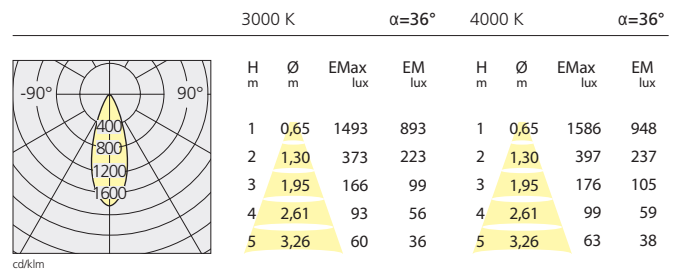

Indirect T16 (G5)
Efficiency 62%

39 W 3100lm

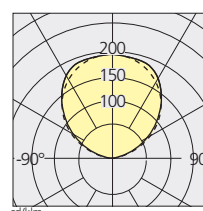

Algoritmo System for PAD Square projectors

Pre-wired gear tray for direct emission

Length	Weight
1184 mm	1,20 kg

Code
M217800

Allows installation and powering of 1-4 PAD 230V projectors.
MV through-wiring included.

Pre-wired gear tray for direct + indirect emission

Length	Weight
1184 mm	1,20 kg

Code
M217900

Allows installation and powering of 1-4 PAD 230V + indirect projectors
T16 (G5) 1x39 W.
MV through-wiring included.



⊕
650°

Double emission version, with upper screen in PMMA. PAD projectors to be ordered separately.

PAD projectors to be ordered separately.

Accessories



Blind panel, in polished metal grey steel.
1 piece required for each PAD Square empty position.

Code
M217760



Intermediate finishing cap (set of 2), in polished metal grey steel.
To be used at the junction of PAD Square modules with FLUO or LED modules.

M217660

Electrical components



Supplementary through-wiring (optional).
To be used in mixed configuration with LV and MV pre-cabled gear trays.

LV	1184 mm
LV	2368 mm

Code
M198800
M199000

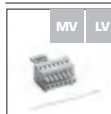

Supply Kit
Enables for connection of the mains to the first pre-wired gear plate of the initial module. To be used only with recessed and surface installation.

LV (3xmax 1,5 mm²)
For supplying LED RGB trays.

MV (7xmax 1,5 mm²)
For powering fluorescent modules, white LED plates and accent modules.

M073230

M073240

Light sources



T16 (G5) fluorescent tube
1 piece

39 W (3000 K)
39 W (4000 K)

Code
M004380
M004381

Closure screens for 90° angles



Junction to be fitted to the module on the same plane
Compatible with the junction for the same plane.

For continuity between dark light fluo emission, LED emission modules and spot modules.

Code
M198000

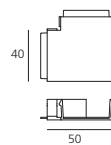

2-plane joint
To be clipped to the module. Compatible with connectors for 2 modules on perpendicular planes.

For continuity between dark light fluo emission, LED emission modules and spot modules.

M198400

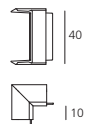

Gloss anodised



IP40 ⊕
650°

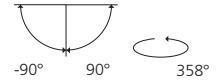

LED						non dimmable	
W	Weight	Beam	Flux	CCT	Color	Code	
29 W	0,97 kg	12°	1650 lm	3000 K	☉	M201502	
			1750 lm	4000 K	☉	M201602	
		24°	1650 lm	3000 K	☉	M201702	
			1750 lm	4000 K	☉	M201802	
		36°	1610 lm	3000 K	☉	M201902	
			1710 lm	4000 K	☉	M202002	



To be coupled with pre-wired gear plate.

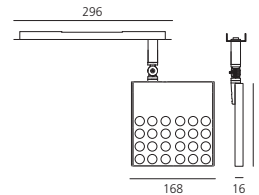

Pad Square 12°

LED		luminaire	
Power	24 W	24 W	29 W
Flux	1988 lm	2120 lm	1650 lm
CCT	3000 K	4000 K	3000 K
CRI	=80 (typ.)		
Color tolerance	MacAdam 4SDCM		
Service life	L70(14K) > 81600h		
Beam			12°
Efficiency			83%
Efficacy	82,8 lm/W	88,2 lm/W	56,8 lm/W

29 W	3000 K	α=12°	4000 K	α=12°			
H m	∅ m	EMax lux	EM lux	H m	∅ m	EMax lux	EM lux
1	0,24	16147	10016	1	0,24	17223	10684
2	0,47	4037	2504	2	0,47	4306	2671
3	0,71	1794	1113	3	0,71	1914	1187
4	0,94	1009	626	4	0,94	1076	668
5	1,18	646	401	5	1,18	689	427

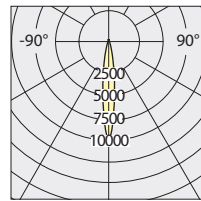

Pad Square 24°

LED		luminaire	
Power	24 W	24 W	29 W
Flux	1988 lm	2120 lm	1650 lm
CCT	3000 K	4000 K	3000 K
CRI	=80 (typ.)		
Color tolerance	MacAdam 4SDCM		
Service life	L70(14K) > 81600h		
Beam			24°
Efficiency			83%
Efficacy	82,8 lm/W	88,2 lm/W	56,9 lm/W

29 W	3000 K	α=24°	4000 K	α=24°			
H m	∅ m	EMax lux	EM lux	H m	∅ m	EMax lux	EM lux
1	0,41	6475	4018	1	0,41	6907	4286
2	0,82	1619	1005	2	0,82	1727	1072
3	1,23	719	446	3	1,23	767	476
4	1,64	405	251	4	1,64	432	268
5	2,05	259	161	5	2,05	276	171

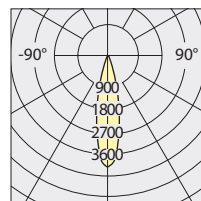

Pad Square 36°

LED		luminaire	
Power	24 W	24 W	29 W
Flux	1988 lm	2120 lm	1610 lm
CCT	3000 K	4000 K	3000 K
CRI	=80 (typ.)		
Color tolerance	MacAdam 4SDCM		
Service life	L70(14K) > 81600h		
Beam			36°
Efficiency			81%
Efficacy	82,8 lm/W	88,2 lm/W	55,5 lm/W

29 W	3000 K	α=36°	4000 K	α=36°			
H m	∅ m	EMax lux	EM lux	H m	∅ m	EMax lux	EM lux
1	0,65	2987	1785	1	0,65	3172	1896
2	1,30	747	446	2	1,30	793	474
3	1,95	332	198	3	1,95	352	211
4	2,61	187	112	4	2,61	198	118
5	3,26	119	71	5	3,26	127	76

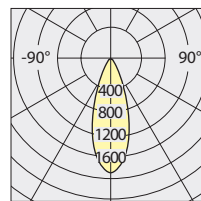

Indirect T16 (G5)

Efficiency 62%

39 W 3100lm

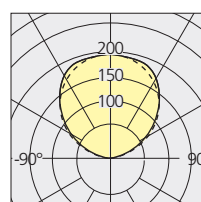

Algoritmo System for 37 Cube projectors

Pre-wired gear tray for direct emission

Length	Weight
1184 mm	1,20 kg

Code
M219600

Allows installation and supplying of 37 Cube, 1 or 2 groups of 3 projectors each. (max 6 projectors in total). MV through-wiring included.

Pre-wired gear tray for direct + indirect emission

Length	Weight
1184 mm	1,20 kg

Code
M219700

Allows installation and supplying of 37 Cube, 1 or 2 groups of 3 projectors each. (max 6 projectors in total), + Indirect T16 (G5) 1x 39 W. MV through-wiring included.



⊕
650°

Double emission version, with upper screen in PMMA. PAD projectors to be ordered separately.

37 Cube projectors to be ordered separately.

Accessories



Blind panel, in polished metal grey steel.
Length 591mm.
1 piece required for each 37 Cube empty position.

Code
M217560



Intermediate finishing cap (set of 2), in polished metal grey steel.
To be used at the junction of 37 Cube modules with FLUO or LED modules.

M217660

Electrical components



Supplementary through-wiring (optional).
To be used in mixed configuration with LV and MV pre-cabled gear trays.

LV	1184 mm
LV	2368 mm

Code
M198800
M199000

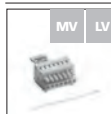

Supply Kit
Enables for connection of the mains to the first pre-wired gear plate of the initial module. To be used only with recessed and surface installation.

LV (3x max 1,5 mm²)
For supplying LED RGB trays.

MV (7x max 1,5 mm²)
For supplying fluorescent modules, white LED plates and accent modules.

M073230

M073240

Light sources



T16 (G5) fluorescent tube
1 piece

39 W (3000 K)
39 W (4000 K)

Code
M004380
M004381

Closure screens for 90° angles



Junction to be fitted to the module on the same plane
Compatible with the junction for the same plane.

For continuity between dark light fluo emission, LED emission modules and spot modules.

Code
M198000

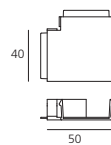

2-plane joint
To be clipped to the module. Compatible with connectors for 2 modules on perpendicular planes.





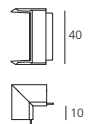

For continuity between dark light fluo emission, LED emission modules and spot modules.

M198400





Kit containing 3 projectors for Algoritmo System

Anodised aluminium

LED				non dimmable		
W (LED)	Weight	Beam	Flux	CCT	Color	Code
3x8 W	0,47 kg	14°	3x483 lm	3000 K		M029100
			3x517 lm	4000 K		M029400
		18°	3x463 lm	3000 K		M029200
			3x495 lm	4000 K		M029500
		30°	3x468 lm	3000 K		M029300
			3x501 lm	4000 K		M029600



IP20 
 650°

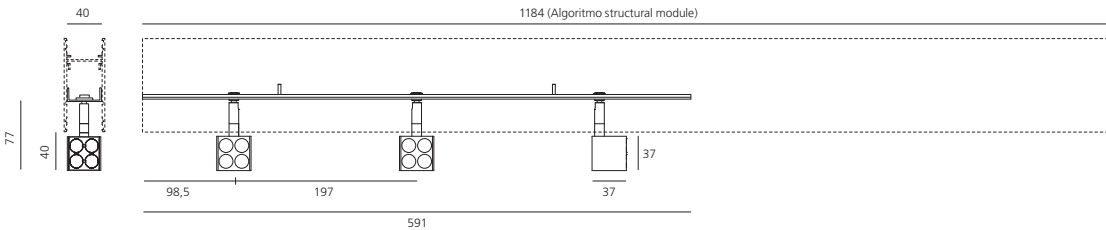

37 Cube 14°	LED		luminaire	
Power	7 W	7 W	8 W	8 W
Flux	528 lm	565 lm	483 lm	517 lm
CCT	3000 K	4000 K	3000 K	4000 K
CRI	=80 (typ.)			
Color tolerance	MacAdam 4SDCM			
Service life	L70(6K) > 50000h			
Beam			14°	14°
Efficiency			92%	92%
Efficacy	75 lm/W	81 lm/W	60 lm/W	65 lm/W

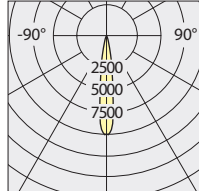
8 W	3000 K		α=14°		4000 K		α=14°	
	H m	Ø m	EMax lux	EM lux	H m	Ø m	EMax lux	EM lux
	1	0,25	4867	3240	1	0,25	5209	3468
	2	0,51	1217	810	2	0,51	1302	867
	3	0,76	541	360	3	0,76	579	385
	4	1,01	304	202	4	1,01	326	217
	5	1,26	195	130	5	1,26	208	139

37 Cube 18°	LED		luminaire	
Power	7 W	7 W	8 W	8 W
Flux	528 lm	565 lm	463 lm	495 lm
CCT	3000 K	4000 K	3000 K	4000 K
CRI	=80 (typ.)			
Color tolerance	MacAdam 4SDCM			
Service life	L70(6K) > 50000h			
Beam			18°	18°
Efficiency			88%	88%
Efficacy	75 lm/W	81 lm/W	58 lm/W	62 lm/W

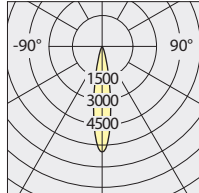
8 W	3000 K		α=18°		4000 K		α=18°	
	H m	Ø m	EMax lux	EM lux	H m	Ø m	EMax lux	EM lux
	1	0,32	2484	1906	1	0,32	3190	2038
	2	0,64	746	476	2	0,64	798	509
	3	0,97	332	212	3	0,97	354	226
	4	1,29	187	119	4	1,29	199	127
	5	1,61	119	76	5	1,61	128	82

37 Cube 30°	LED		luminaire	
Power	7 W	7 W	8 W	8 W
Flux	528 lm	565 lm	468 lm	501 lm
CCT	3000 K	4000 K	3000 K	4000 K
CRI	=80 (typ.)			
Color tolerance	MacAdam 4SDCM			
Service life	L70(6K) > 50000h			
Beam			30°	30°
Efficiency			89%	89%
Efficacy	75 lm/W	81 lm/W	59 lm/W	63 lm/W

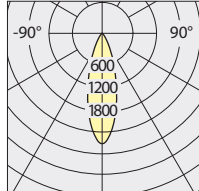
8 W	3000 K		α=30°		4000 K		α=30°	
	H m	Ø m	EMax lux	EM lux	H m	Ø m	EMax lux	EM lux
	1	0,54	1230	740	1	0,54	1316	793
	2	1,07	307	185	2	1,07	329	198
	3	1,61	137	82	3	1,61	146	88
	4	2,14	77	46	4	2,14	82	50
	5	2,68	49	30	5	2,68	53	32

Algoritmo LED Management (LV): electrical diagram

Stand-alone 1 *

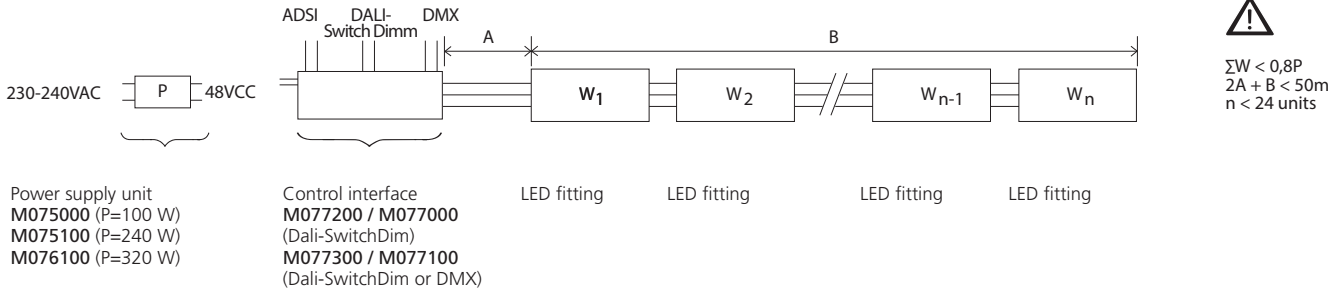

Stand-alone 2 *

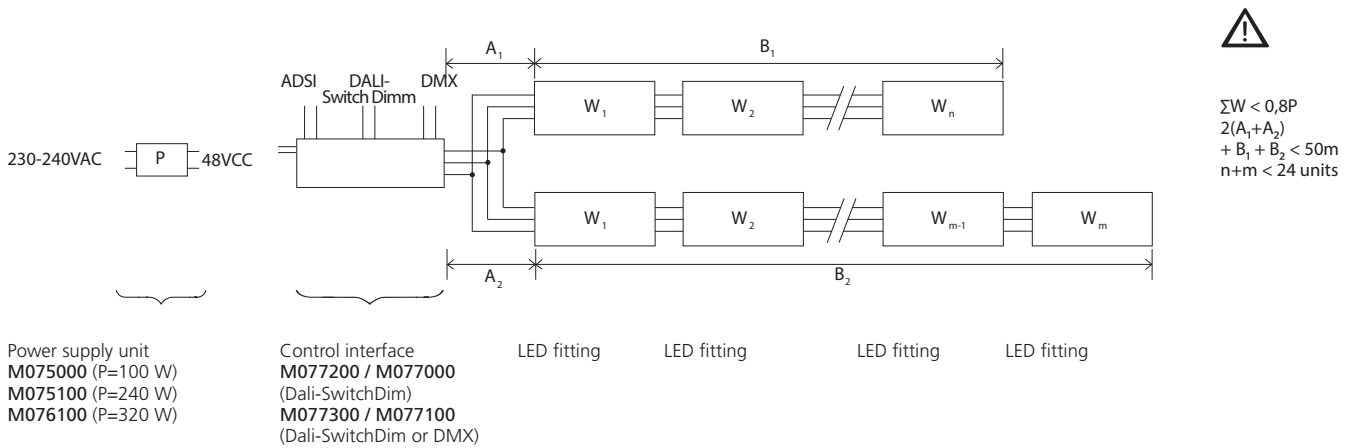

* Maximum values.

For lighting design, please see data in the control interface manual.

Master-slave *

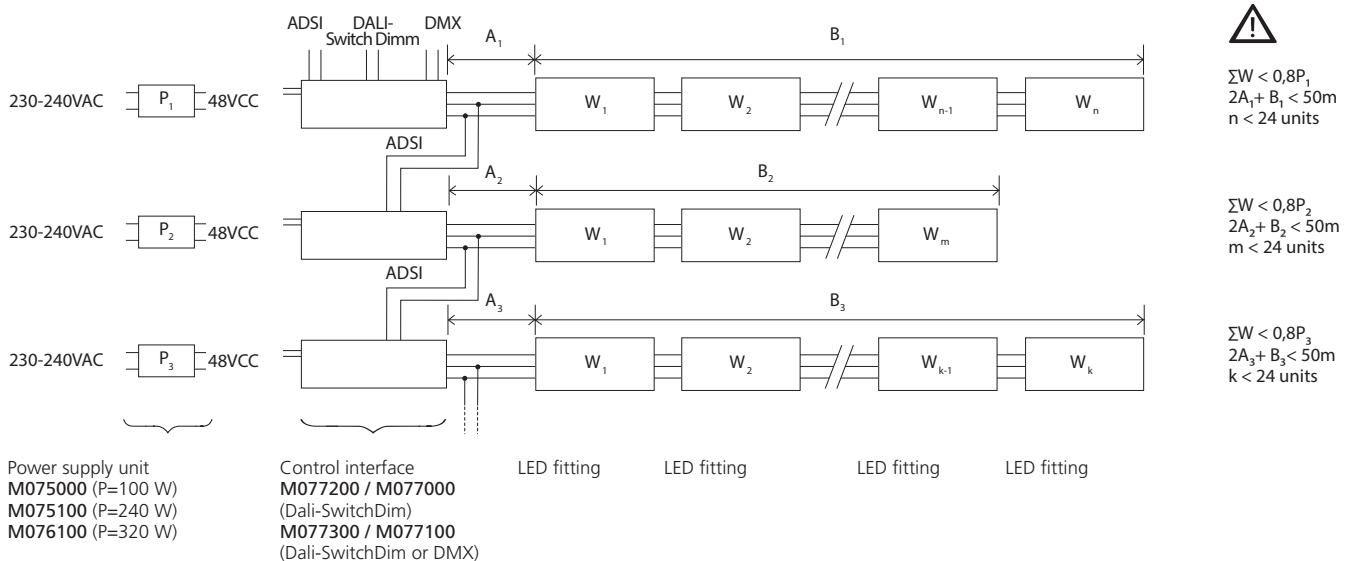



Steelcase headquarters and showroom Madrid. Arch: John Small, architect; a director of design for Steelcase International. Photo: Juanjo Fernandez

Algoritmo Stand alone

Carlotta de Bevilacqua
Paola di Arianello
2010

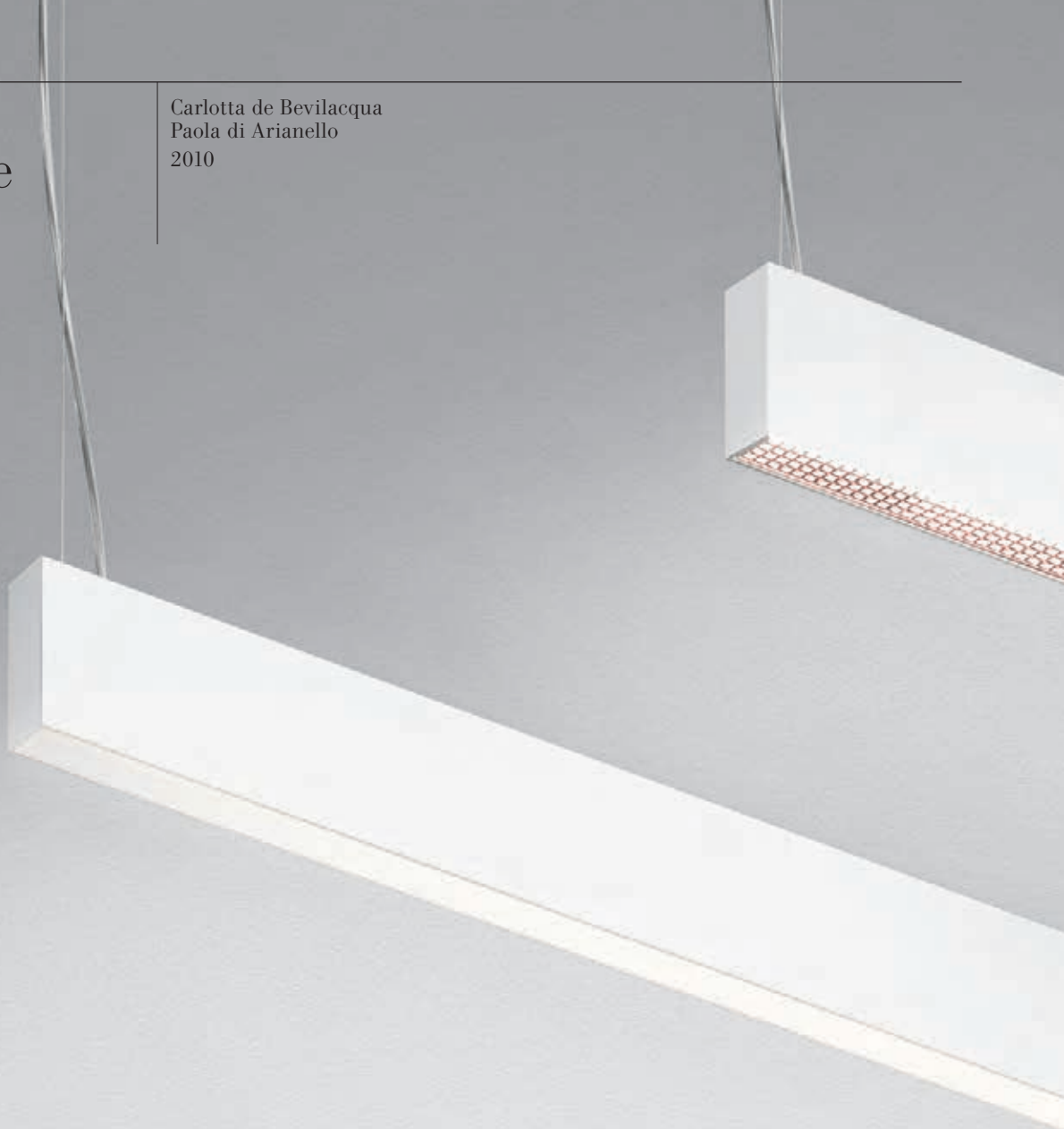

- Series of single units, preconfigured and complete for suspension-mounting, wall-mounting and ceiling-mounting.
- Body in extruded aluminium, painted white or gloss anodised. Two lengths available: 1188 mm and 2372mm.
- T16-seamless fluorescent version with opal diffuser or dark light optic. Power supply: electronic or dimmable electronic with 'multiwatt' control gear 28/54 W DALI/SwitchDim.
- LED version direct emission, diffused, controlled or prismoptic: LED monochromatic warm white (3000 K) and neutral white (4000 K), or RGB LED (only diffused).
- Power supply and light management system included, non dimmable or Dali-SwitchDim.
- Suspended version direct or double emission (indirect fluo).
- Luminaires come complete with end caps, fixing brackets or suspension cables and optics.
- T16-Seamless tubes to be ordered separately.
- Compliant with standard EN60598-1 and other specific standards.





Algoritmo Stand-alone white LED diffused emission

White Gloss anodised

Suspension Direct emission

LED White

non dimmable

Dali-SwitchDim

W	Length	Weight	Flux	CCT	Color
23 W	1188 mm	3,80 kg	1213 lm	3000 K	<input type="radio"/>
	1188 mm		1303 lm	4000 K	<input checked="" type="radio"/>
46 W	2372 mm	7,10 kg	2426 lm	3000 K	<input type="radio"/>
	2372 mm		2606 lm	4000 K	<input checked="" type="radio"/>

Code
M146620
M146660
M146720
M146760
M147920
M147960
M148020
M148060

Code
M146621
M146661
M146721
M146761
M147921
M147961
M148021
M148061



LED

Suspension Direct + Indirect emission

LED White + fluo

non dimmable

Dali-SwitchDim*

W	Length	Weight	CCT	Color
23 W	1188 mm	4,00 kg	3000 K	<input type="radio"/>
1x39 W (T16 (G5))	1188 mm	4,00 kg	4000 K	<input type="radio"/>
			4000 K	<input checked="" type="radio"/>
46 W	2372 mm	7,30 kg	3000 K	<input type="radio"/>
2x39 W (T16 (G5))	2372 mm	7,30 kg	4000 K	<input type="radio"/>
			4000 K	<input checked="" type="radio"/>

Code
M146820
M146860
M146920
M146960
M148120
M148160
M148220
M148260

Code
M146821
M146861
M146921
M146961
M148121
M148161
M148221
M148261

IP20 850° (direct)
650° (direct+indirect)

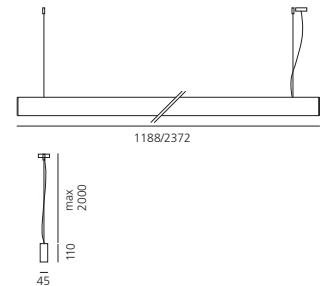

* Only direct emission is dimmable.
Upper screen in PMMA included.

Wall/ceiling Direct emission

LED White

non dimmable

Dali-SwitchDim*

W	Length	Weight	Flux	CCT	Color
23 W	1188 mm	3,80 kg	1213 lm	3000 K	<input type="radio"/>
			1303 lm	4000 K	<input checked="" type="radio"/>
46 W	2372 mm	7,10 kg	2426 lm	3000 K	<input type="radio"/>
			2606 lm	4000 K	<input checked="" type="radio"/>

Code
M148320
M148360
M148420
M148460
M149620
M149660
M149720
M149760

Code
M148321
M148361
M148421
M148461
M149621
M149661
M149721
M149761

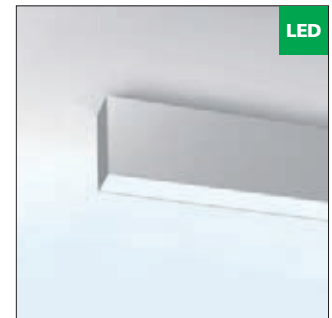

LED

IP20 850°

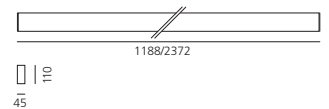

LED direct

LED direct

luminaire

23 W

Indirect T16 (G5)

39 W

3100 lm

Power	20 W	20 W	23 W	23 W
Flux	2550 lm	2729 lm	1213 lm	1303 lm
CCT	3000 K	4000 K	3000 K	4000 K
CRI	=80 (typ.)			
Color tolerance	MacAdam 3SDCM			
Service life	L70(6K) > 50000h			
Beam				
Efficiency			48%	48%
Efficacy	128 lm/W	136 lm/W	53 lm/W	57 lm/W

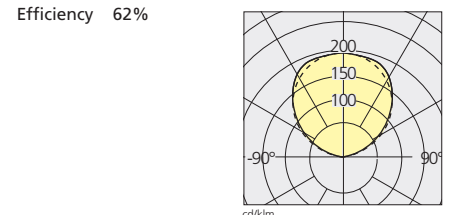
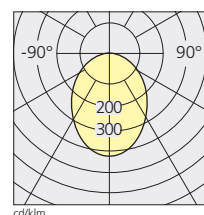

Values for luminaire body L 1188 mm.

Algoritmo Stand-alone fluo direct emission

White Gloss anodised

Suspension Direct emission

T16-SLS (G5)				non dimmable
W	Length	Weight	Color	Code
1x54 W	1188 mm	3,80 kg	<input type="radio"/>	M205420
			<input checked="" type="radio"/>	M205460
2x54 W	2372 mm	7,10 kg	<input type="radio"/>	M205520
			<input checked="" type="radio"/>	M205560

T16-SLS (G5)				Dali-SwitchDim
W	Length	Weight	Color	Code
1x28-54 W	1188 mm	3,80 kg	<input type="radio"/>	M205421
			<input checked="" type="radio"/>	M205461
2x28-54 W	2372 mm	7,10 kg	<input type="radio"/>	M205521
			<input checked="" type="radio"/>	M205561

Suspension Direct + Indirect emission

T16-SLS (G5)				non dimmable
W	Length	Weight	Color	Code
1x54 W (T16-SLS (G5))	1188 mm	4,00 kg	<input type="radio"/>	M205620
+ 1x39 W (T16 (G5))			<input checked="" type="radio"/>	M205660
2x54 W (T16-SLS (G5))	2372 mm	7,30 kg	<input type="radio"/>	M205720
+ 2x39 W (T16 (G5))			<input checked="" type="radio"/>	M205760

T16-SLS (G5)				Dali-SwitchDim*
W	Length	Weight	Color	Code
1x28-54 W (T16-SLS (G5))	1188 mm	4,00 kg	<input type="radio"/>	M205621
+ 1x39 W (T16 (G5))			<input checked="" type="radio"/>	M205661
2x28-54 W (T16-SLS (G5))	2372 mm	7,30 kg	<input type="radio"/>	M205721
+ 2x39 W (T16 (G5))			<input checked="" type="radio"/>	M205761

* Only direct emission is dimmable.
Upper screen in PMMA included.

Wall/ceiling Direct emission

T16-SLS (G5)				non dimmable
W	Length	Weight	Color	Code
1x54 W	1188 mm	3,80 kg	<input type="radio"/>	M205220
			<input checked="" type="radio"/>	M205260
2x54 W	2372 mm	7,10 kg	<input type="radio"/>	M205320
			<input checked="" type="radio"/>	M205360

T16-SLS (G5)				Dali-SwitchDim
W	Length	Weight	Color	Code
1x28-54 W	1188 mm	3,80 kg	<input type="radio"/>	M205221
			<input checked="" type="radio"/>	M205261
2x28-54 W	2372 mm	7,10 kg	<input type="radio"/>	M205321
			<input checked="" type="radio"/>	M205361

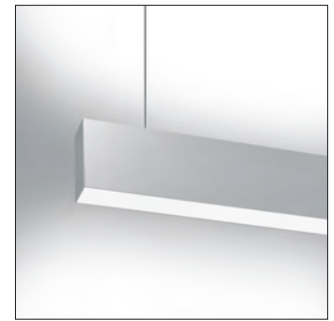

IP20 650°

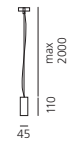
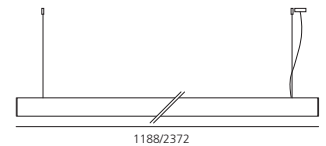

IP20 650°

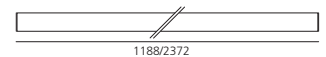

T16-SLS (G5)
Efficiency 56%

28/54 W 2600/4450 lm

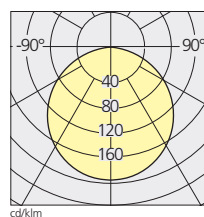

Indirect T16 (G5)
Efficiency 62%

39 W 3100 lm

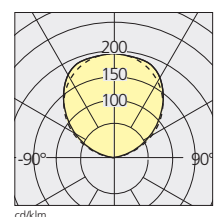

Algoritmo Stand-alone white LED controlled emission

Patent pending (IT) n° MI2013A001711

White Gloss anodised

Suspension Direct emission

LED White

non dimmable

Dali-SwitchDim

W	Length	Weight	Flux	CCT	Color	Code	Code
34 W	1188 mm	3,80 kg	1500 lm	3000 K	<input type="radio"/>	M2886W20	M2886W21
			1605 lm	4000 K	<input checked="" type="radio"/>	M2886W60	M2886W61
	2372 mm	7,10 kg	3000 lm	3000 K	<input type="radio"/>	M2886N20	M2886N21
			3210 lm	4000 K	<input checked="" type="radio"/>	M2886N60	M2886N61

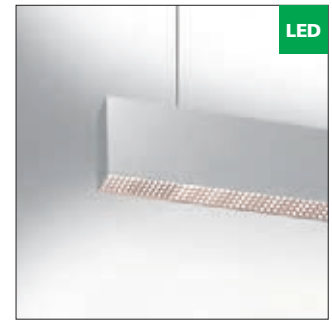

Suspension Direct + Indirect emission

LED White + fluo

non dimmable

Dali-SwitchDim*

W	Length	Weight	CCT	Color	Code	Code
34 W +	1188 mm	4,00 kg	3000 K	<input type="radio"/>	M2888W20	M2888W21
30 W			4000 K	<input checked="" type="radio"/>	M2888W60	M2888W61
68 W +	1188 mm	4,00 kg	3000 K	<input type="radio"/>	M2888N20	M2888N21
			4000 K	<input checked="" type="radio"/>	M2888N60	M2888N61
	2372 mm	7,30 kg	3000 K	<input type="radio"/>	M2889W20	M2889W21
			4000 K	<input checked="" type="radio"/>	M2889W60	M2889W61
60 W	2372 mm	7,30 kg	4000 K	<input type="radio"/>	M2889N20	M2889N21
				<input checked="" type="radio"/>	M2889N60	M2889N61

IP20 \oplus 850° (direct)
650° (direct+indirect)

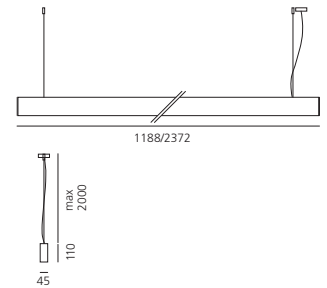

* Only direct emission is dimmable.
Upper screen is included.

Ceiling Direct emission

LED White

non dimmable

Dali-SwitchDim

W	Length	Weight	Flux	CCT	Color	Code	Code
34 W	1188 mm	3,80 kg	1500 lm	3000 K	<input type="radio"/>	M2890W20	M2890W21
			1605 lm	4000 K	<input checked="" type="radio"/>	M2890W60	M2890W61
	2372 mm	7,10 kg	3000 lm	3000 K	<input type="radio"/>	M2890N20	M2890N21
			3210 lm	4000 K	<input checked="" type="radio"/>	M2890N60	M2890N61



Algoritmo white LED

LED	luminaire	
29 W	29 W	34 W
3361 lm	3596 lm	1500 lm
3000 K	4000 K	3000 K
=80 (typ.)		4000 K
MacAdam 4SDCM		
L70(9K) > 50000h		
	C0-C180	C0-C180
	79°	79°
	C90-C270	C90-C270
	93°	93°
	45%	45%
116 lm/W	124 lm/W	44 lm/W
		47 lm/W

34 W

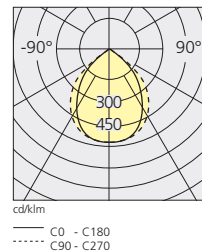

IP20 \oplus 850°

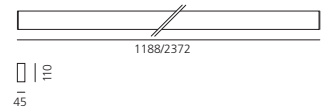

Algoritmo white LED

LED	luminaire	
27 W	27 W	30 W
4240 lm	4400 lm	3307 lm
3000 K	4000 K	3000 K
=80 (typ.)		4000 K
MacAdam 4SDCM		
L70(9K) > 50000h		
	78%	78%
157 lm/W	163 lm/W	110 lm/W
		114 lm/W

30 W

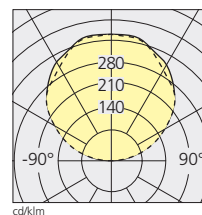

Values for luminaire body L 1188 mm.

Algoritmo Stand-alone white LED controlled prismoptic

White Gloss anodised

Suspension Direct emission

LED White

W	Length	Weight	Flux	CCT	Color
23 W	1188 mm	3,80 kg	1402 lm	3000 K	<input type="radio"/>
	1188 mm	3,80 kg	1520 lm	4000 K	<input checked="" type="radio"/>
46 W	2372 mm	7,10 kg	2804 lm	3000 K	<input type="radio"/>
	2372 mm	7,10 kg	3040 lm	4000 K	<input checked="" type="radio"/>

non dimmable

Code
M2892W20
M2892W60
M2892N20
M2892N60
M2893W20
M2893W60
M2893N20
M2893N60

Dali-SwitchDim

Code
M2892W21
M2892W61
M2892N21
M2892N61
M2893W21
M2893W61
M2893N21
M2893N61



Suspension Direct + Indirect emission fluo

LED White + fluo

W	Length	Weight	CCT (LED)	Color
23 W	1188 mm	4,00 kg	3000 K	<input type="radio"/>
1x39 W (T16 (G5))	1188 mm	4,00 kg	4000 K	<input type="radio"/>
			<input checked="" type="radio"/>	
46 W	2372 mm	7,30 kg	3000 K	<input type="radio"/>
			4000 K	<input checked="" type="radio"/>
2x39 W (T16 (G5))	2372 mm	7,30 kg	3000 K	<input type="radio"/>
			4000 K	<input checked="" type="radio"/>

non dimmable

Code
M2894W20
M2894W60
M2894N20
M2894N60
M2895W20
M2895W60
M2895N20
M2895N60

Dali-SwitchDim*

Code
M2894W21
M2894W61
M2894N21
M2894N61
M2895W21
M2895W61
M2895N21
M2895N61

IP20 850° (direct)
650° (direct+indirect)

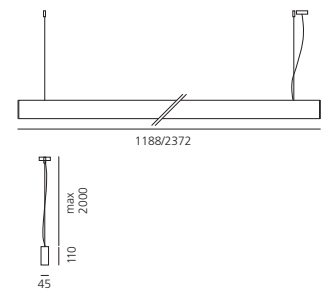

* Only direct emission is dimmable.
Upper screen in PMMA included.

Ceiling Direct emission

LED White

W	Length	Weight	Flux	CCT	Color
23 W	1188 mm	3,80 kg	1402 lm	3000 K	<input type="radio"/>
	1188 mm	3,80 kg	1520 lm	4000 K	<input checked="" type="radio"/>
46 W	2372 mm	7,10 kg	2804 lm	3000 K	<input type="radio"/>
	2372 mm	7,10 kg	3040 lm	4000 K	<input checked="" type="radio"/>

non dimmable

Code
M2896W20
M2896W60
M2896N20
M2896N60
M2897W20
M2897W60
M2897N20
M2897N60

Dali-SwitchDim

Code
M2896W21
M2896W61
M2896N21
M2896N61
M2897W21
M2897W61
M2897N21
M2897N61



IP20 850°

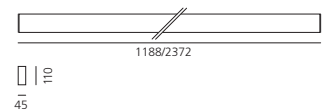

23 W

3000 K

4000 K

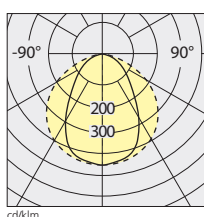

H m	Ø m	EMax lux	EM lux
1	1,47	645	212
2	2,94	161	53
3	4,41	72	24
4	5,87	40	13
5	7,34	26	8

H m	Ø m	EMax lux	EM lux
1	1,47	700	230
2	2,94	175	57
3	4,41	78	26
4	5,87	44	14
5	7,34	28	9

Indirect T16 (G5)

Efficiency 62%

39 W

3100 lm

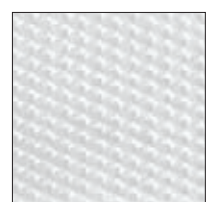
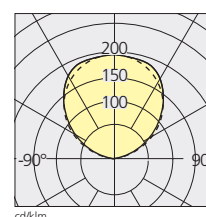

— C0 - C180
..... C90 - C270

Values for luminaire body L 1188 mm.

Algoritmo Stand-alone fluo dark light emission

White Gloss anodised

Suspension Direct emission

T16-SLS (G5)				non dimmable
W	Length	Weight	Color	Code
1x54 W	1188 mm	3,80 kg	<input type="radio"/>	M207020
			<input checked="" type="radio"/>	M207060
2x54 W	2372 mm	7,10 kg	<input type="radio"/>	M207120
			<input checked="" type="radio"/>	M207160

T16-SLS (G5)				Dali-SwitchDim
W	Length	Weight	Color	Code
1x28-54 W	1188 mm	3,80 kg	<input type="radio"/>	M207021
			<input checked="" type="radio"/>	M207061
2x28-54 W	2372 mm	7,10 kg	<input type="radio"/>	M207121
			<input checked="" type="radio"/>	M207161

Suspension Direct + Indirect emission

T16-SLS (G5)				non dimmable
W	Length	Weight	Color	Code
1x54 W (T16-SLS (G5))	1188 mm	4,00 kg	<input type="radio"/>	M207220
+ 1x39 W (T16 (G5))			<input checked="" type="radio"/>	M207260
2x54 W (T16-SLS (G5))	2372 mm	7,30 kg	<input type="radio"/>	M207320
+ 2x39 W (T16 (G5))			<input checked="" type="radio"/>	M207360

T16-SLS (G5)				Dali-SwitchDim*
W	Length	Weight	Color	Code
1x28-54 W (T16-SLS (G5))	1188 mm	4,00 kg	<input type="radio"/>	M207221
+ 1x39 W (T16 (G5))			<input checked="" type="radio"/>	M207261
2x28-54 W (T16-SLS (G5))	2372 mm	7,30 kg	<input type="radio"/>	M207321
+ 2x39 W (T16 (G5))			<input checked="" type="radio"/>	M207361

* Only direct emission is dimmable.
Upper screen in PMMA included.

Ceiling Direct emission

T16-SLS (G5)				non dimmable
W	Length	Weight	Color	Code
1x54 W	1188 mm	3,80 kg	<input type="radio"/>	M206820
			<input checked="" type="radio"/>	M206860
2x54 W	2372 mm	7,10 kg	<input type="radio"/>	M206920
			<input checked="" type="radio"/>	M206960

T16-SLS (G5)				Dali-SwitchDim
W	Length	Weight	Color	Code
1x28-54 W	1188 mm	3,80 kg	<input type="radio"/>	M206821
			<input checked="" type="radio"/>	M206861
2x28-54 W	2372 mm	7,10 kg	<input type="radio"/>	M206921
			<input checked="" type="radio"/>	M206961



IP20 960°

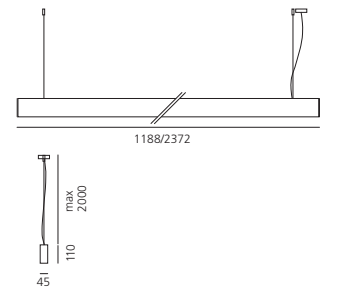

IP20 960°

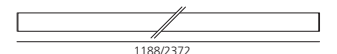

45

Direct T16-SLS (G5) 28/54 W 2600/4450 lm

Efficiency 33%

UGR < 19		
2θ/2 = 85°	54 W	28 W
E ₀ (h 1m)	916 lux	531 lux
E ₀ (h 2m)	229 lux	133 lux

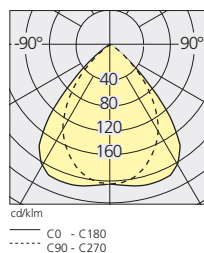

Indirect T16 (G5) 39 W 3100 lm

Efficiency 62%

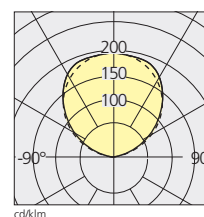

cd/klm
— C0 - C180
..... C90 - C270

cd/klm

Algoritmo Stand-alone RGB LED diffused emission

White Gloss anodised

Suspension Direct emission

LED RGB				Dali dimmable
W	Length	Weight	Color	Code
21 W	1188 mm	3,80 kg	<input type="radio"/>	M207420
			<input checked="" type="radio"/>	M207460
42 W	2372 mm	7,10 kg	<input type="radio"/>	M207520
			<input checked="" type="radio"/>	M207560

Uses 3 dali addresses .

Suspension Direct + Indirect emission

LED RGB				Dali dimmable*
W	Length	Weight	Color	Code
21 W	1188 mm	4,00 kg	<input type="radio"/>	M207620
1x39 W (T16 (G5))			<input checked="" type="radio"/>	M207660
42 W	2372 mm	7,30 kg	<input type="radio"/>	M207720
1x39 W (T16 (G5))			<input checked="" type="radio"/>	M207760

*Only direct emission is dimmable.
Uses 3 dali addresses .
Upper screen in PMMA included.

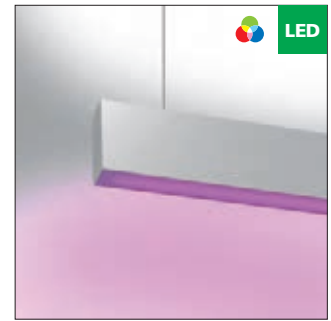

IP20 850° (direct)
650° (direct+indirect)

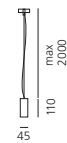
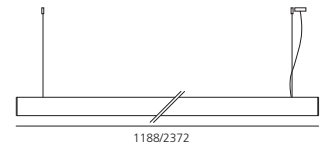

Wall/ceiling Direct emission

LED RGB				Dali dimmable
W	Length	Weight	Color	Code
21 W	1188 mm	3,80 kg	<input type="radio"/>	M207820
			<input checked="" type="radio"/>	M207860
42 W	2372 mm	7,10 kg	<input type="radio"/>	M207920
			<input checked="" type="radio"/>	M207960

Uses 3 dali addresses .

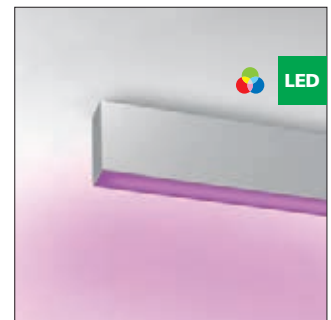

IP20 850°

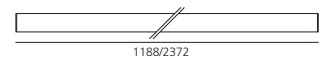

Indirect T16 (G5)

Efficiency 62%

39 W 3100 lm

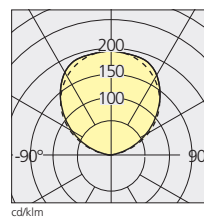

Light sources

**T16-SEAMLESS (G5)
fluorescent tube**
1 piece

28 W (3000 K)

28 W (4000 K)

54 W (3000 K)

54 W (4000 K)

Code

M004810

M004815

M004800

M004805

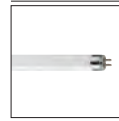

T16 (G5) fluorescent tube
1 piece

39 W (3000 K)

39 W (4000 K)

M004380

M004381

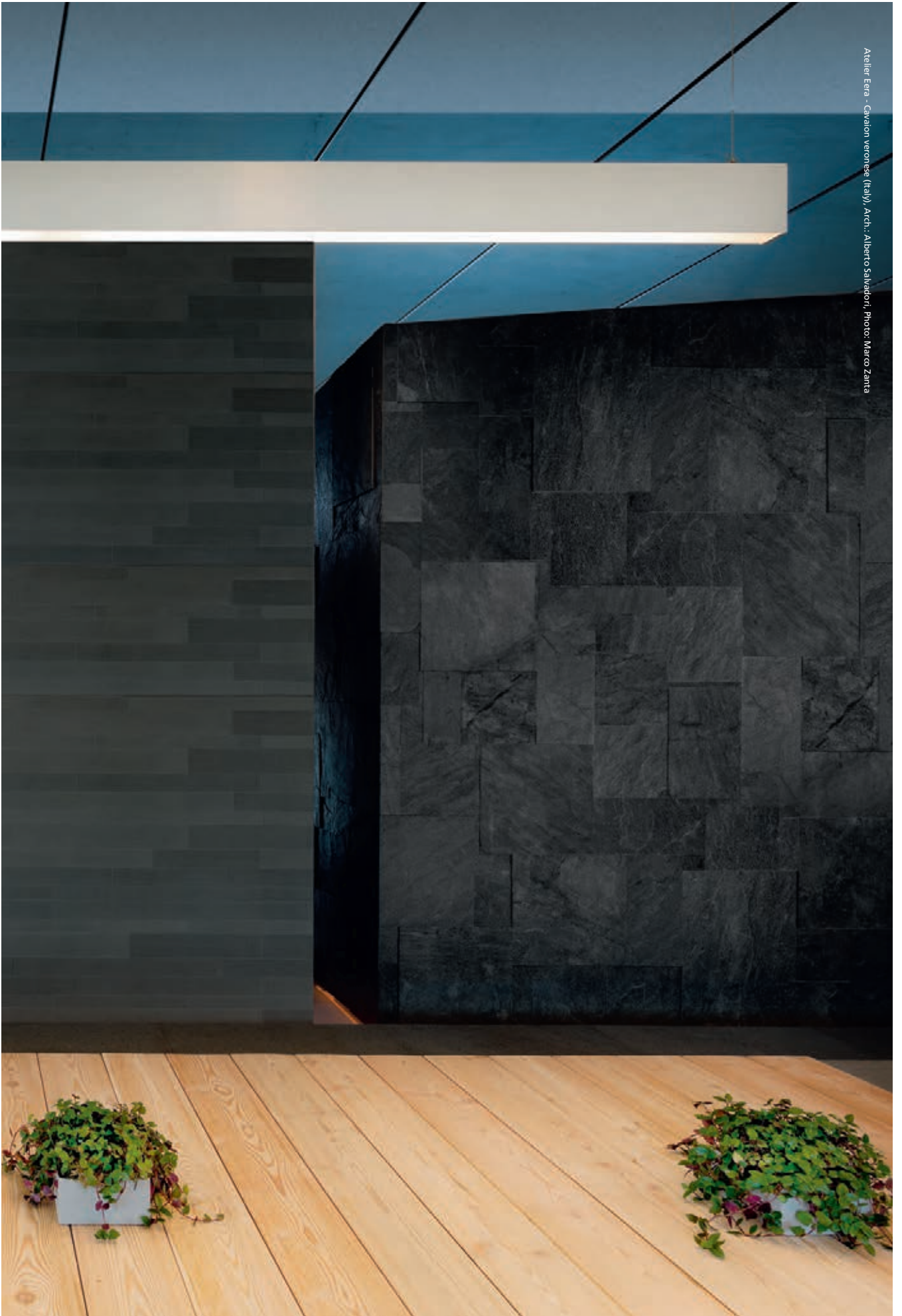

Nothing 86 System

Ernesto Gismondi
2013





Nothing 86 is a versatile modular lighting system for linear diffused or dark light emissions and freely configurable accent lighting.

Nothing 86 System recessed





Nothing 86 System Recessed ceiling Components

Structural modules

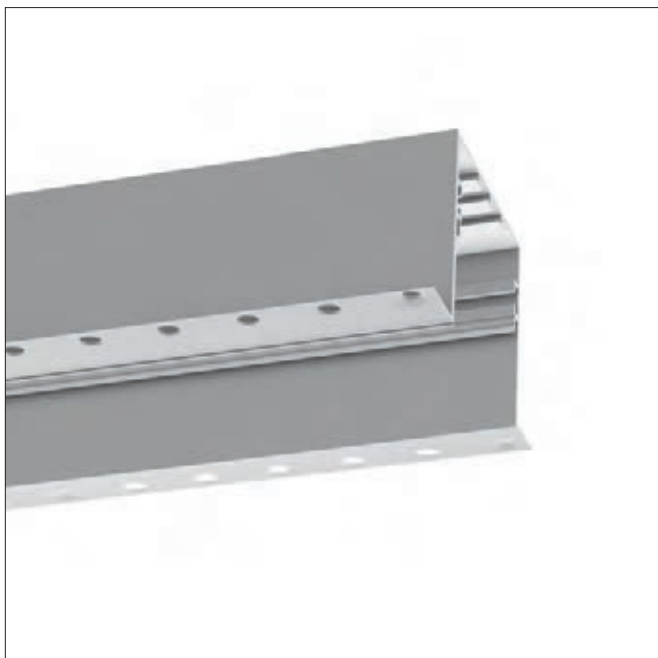

Structural module for recessed wall installation. Trimless ring, needs plaster finish. End caps, angles, intermediate connectors and optics to be ordered separately.

- Recessed ceiling modular system.
- Components: structural modules in extruded aluminium, pre-wired gear trays and optics.
- Structural modules available in 10 lengths (from 237 to 4736 mm) and, thanks to their flexibility, can house and freely alternate light sources.
- The original sequence can be modified over time, provided the total length of the system is kept the same.
- Linear fluorescent sources with diffused or dark light emissions, white or RB LEDs with diffused emission, spot modules for accent lighting can be alternated to customize the sequence, with or without fluorescent indirect emission.
- Feeding plates with through-cablings and rapid connectors.
- To remove shadows in the joining area between 2 fluorescent lights, T16-Seamless lamps or traditional T16 fluorescent tubes with overlapping arrangements for uninterrupted light lines.
- 2 LED versions: with monochromatic warm white emissions (3000K), neutral white emission (4000K) and RGB emission.
- Same-plane angular configurations available, perpendicular angular configurations available on request.
- Compliant with standard EN60598-1 and other specific standards.

+ Junction components +

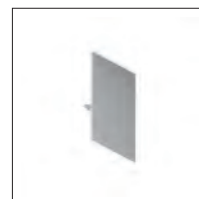

End caps. (set of 2)



Intermediate connector. (to be used for combining spotlighting modules with dark light or diffusing emission).



90° angle. (to mechanically connect 2 recessed modules on the same plane).

Pre-wired gear trays

+

Electrical components

+

Optical system

+

Closing / joining screens

+

LED power supplies and control systems

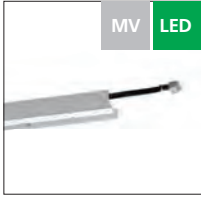

Pre-wired gear tray for white LED direct diffused emission prismatic. Integrated MV through-wiring.



Pre-wired gear tray for white RGB LED direct diffused emission. Integrated LV through-wiring.



Supplementary through-wiring (Optional). To be used in configuration with LV and MV pre-cabled gear trays.

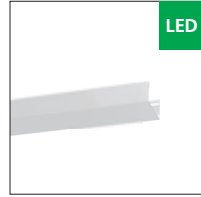

Opal diffuser in polycarbonate for LED diffused versions.



Junction to be fitted to the module on the same plane. Compatible with the junction for the same plane.



Electronic power supply unit. IP67.



Pre-wired gear tray for fluorescent T16 tubes. Diffused direct emission. Integrated MV through-wiring.



Pre-wired gear tray for fluorescent T16 tubes. Dark light diffused direct emission. Integrated MV through-wiring.

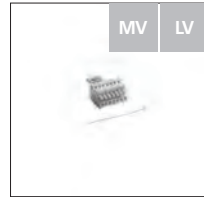

Power supply kit.



Opal PMMA diffuser for fluorescent versions.



Control interface: IP20 and IP67. Allows management of groups of LV fittings.



Pre-wired gear tray for fluorescent T16-SLS tubes. Diffused direct emission. Integrated MV through-wiring.



Accent modules.













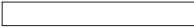



Dark light optics for fluorescent versions.





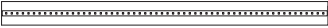
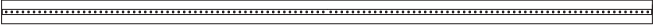

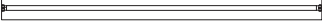



Prismoptics optics for white LED versions.

Nothing 86 System Recessed ceiling

Structural modules	Length
	237 mm 1L
	474 mm 2L
	710 mm 3L
	947 mm 4L
	1184 mm 5L
	1421 mm 6L
	2368 mm 10L
	2605 mm 11L
	1170 mm 1DL
	2340 mm 2DL

Pre-wired gear trays		Length
	Accent module	237 mm 1L
	LED pre-wired gear tray	1184 mm 5L
	LED pre-wired gear tray	2368 mm 10L
	T16-SLS diffused pre-wired gear tray	1184 mm 5L
	Diffused fluo T16 gear	1421 mm 6L
	Dark-light fluo T16 gear (single)	1170 mm 1DL
	Dark-light fluo T16 gear (dual)	2340 mm 2DL

Optics		Length
	Diffusor for LED or Fluo	1184 mm 5L
	Diffusor for LED or Fluo	1421 mm 6L
	Diffusor for LED or Fluo	2368 mm 10L
	Diffusor for LED or Fluo	2605 mm 11L
	Diffusor for LED or Fluo	4736 mm 20L
	Dark light Fluo Optic	1170 mm 1DL
	Prismoptic for white LED	1184 mm 5L
	Prismoptic for white LED	2368 mm 10L

White



Gloss anodised



Structural module

Length		Color	Code
237 mm	1L	<input type="radio"/>	M230000
474 mm	2L	<input type="radio"/>	M230100
710 mm	3L	<input type="radio"/>	M230200
947 mm	4L	<input type="radio"/>	M230300
1184 mm	5L	<input type="radio"/>	M230400
1421 mm	6L	<input type="radio"/>	M230500
2368 mm	10L	<input type="radio"/>	M230600
2605 mm	11L	<input type="radio"/>	M230700
1170 mm	1DL	<input type="radio"/>	M230900
2340 mm	2DL	<input type="radio"/>	M231000

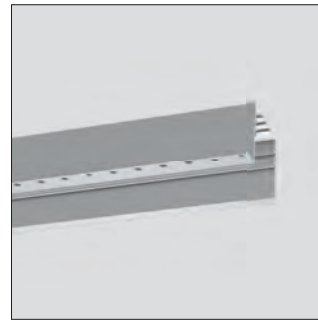

$100 \times (\Sigma L + 10 \text{ mm})$



Accessories

	Color	Code
<p>End caps (set of 2)</p>		M232400
<p>Intermediate joint Used to connect accent lighting modules to dark light or diffused modules.</p>	<input type="radio"/> <input checked="" type="radio"/>	M194620 M194660
<p>90° joint To connect two recessed modules on the same plane.</p>		M181700

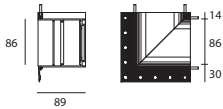

Nothing 86 System ceiling/suspension











Nothing 86 System Ceiling/Suspension Components

Structural modules

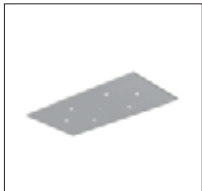

Structural module for ceiling- or suspended-mounting. End caps, angles, fixing components, plates and optics to be ordered separately.

- Ceiling-mounted and suspended modular system.
- Components: structural modules in extruded aluminium, pre-wired gear trays and optics.
- Structural modules available in 12 lengths (from 237 to 4736 mm) and, thanks to their flexibility, can house and freely alternate luminaires.
- The original sequence can be modified over time, provided the total length of the system is kept the same.
- Linear fluorescent sources with diffused or dark light emissions, white or RB LEDs with diffused emission and prismoptic, spot modules for accent lighting can be alternated to customize the sequence, with or without fluorescent indirect emission.
- Supply plates with through-wiring and rapid connectors.
- To remove shadows in the joining area between 2 fluorescent lights, T16-Seamless lamps or traditional T16 fluorescent tubes with overlapping arrangements for uninterrupted light lines.
- 2 LED versions: with monochromatic warm white emissions (3000K), neutral white emission (4000K) and RGB emission.
- Same-plane angular configurations available, perpendicular angular configurations available on request.
- Compliant with standard EN60598-1 and other specific standards.

+ Installation components	+ Junction components
 <p>Ceiling fixing bracket (1 piece)</p>	 <p>End caps (set of 2)</p>
 <p>Steel suspension cable (1 piece)</p>	 <p>Intermediate joint (to be used for combining spotlighting modules with fluorescent modules with dark light or diffusing emission)</p>
 <p>Suspension set with steel cable and power supply cable (1 piece) Length 2000mm</p>	 <p>Linear connector</p>
	 <p>90° joint (to connect two modules on one same plane).</p>

Pre-wired gear trays

+

Electrical components

+

Optical system

+

Closing / joining screens

+

LED power supplies and control systems

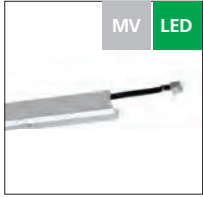

Pre-wired gear tray for white LED direct diffused emission and prismatic. Integrated MV through-wiring.



Pre-wired gear tray for white RGB LED direct diffused emission. Integrated LV through-wiring.



Supplementary through-wiring (Optional). To be used in configuration with LV and MV pre-cabled gear trays.

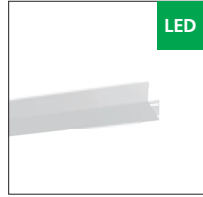

Opal diffuser in polycarbonate for LED diffused versions.



Joints between each two modules on the same level. Compatible with joints for connection on the same level.



Electronic power supply unit. IP67.



Pre-wired gear tray for fluorescent T16 tubes. Diffused direct emission. Integrated MV through-wiring.



Pre-wired gear tray for fluorescent T16 tubes. Indirect emission.

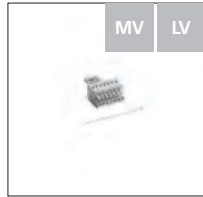

Power supply kit.

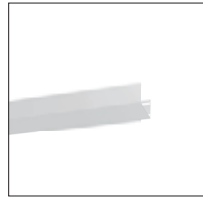

Opal PMMA diffuser for fluorescent versions.



Control interface: IP20 and IP67. Allows management of groups of LV fittings.



Pre-wired gear tray for fluorescent T16-SLS tubes. Diffused direct emission. Integrated MV through-wiring.



Pre-wired gear tray for fluorescent T16 tubes. Dark light direct emission. Integrated MV through-wiring.



Dark light optics for fluorescent versions.













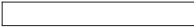







Accent modules.







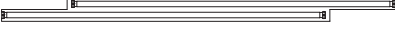

PMMA prismatic optics.

Nothing 86 System Ceiling/Suspension

Structural modules	Length
	237 mm 1L
	474 mm 2L
	710 mm 3L
	947 mm 4L
	1184 mm 5L
	1421 mm 6L
	2368 mm 10L
	2605 mm 11L
	4736 mm 20L
	1170 mm 1DL
	2340 mm 2DL
	4680 mm 4DL

Pre-wired gear trays		Length
	Accent module	237 mm 1L
	LED pre-wired gear tray	1184 mm 5L
	LED pre-wired gear tray	2368 mm 10L
	T16-SLS diffused pre-wired gear tray	1184 mm 5L
	Piastra Fluo diffuser T16	1421 mm 6L
	Piastra Fluo dark-light T16 (single)	1170 mm 1DL
	Piastra Fluo dark-light T16 (double)	2340 mm 2DL

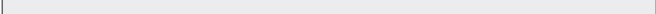
Optics		Length
	Diffuser for LED or Fluo	1184 mm 5L
	Diffuser for LED or Fluo	1421 mm 6L
	Diffuser for LED or Fluo	2368 mm 10L
	Diffuser for LED or Fluo	2605 mm 11L
	Diffuser for LED or Fluo	4736 mm 20L
	Dark light Fluo Optic	1170 mm 1DL
	Prismoptic for white LED	1184 mm 5L
	Prismoptic for white LED	2368 mm 10L

White Gloss anodised

Structural module

Length		Color	Code
237 mm	1L	<input type="radio"/>	M231220
		<input checked="" type="radio"/>	M231260
474 mm	2L	<input type="radio"/>	M231320
		<input checked="" type="radio"/>	M231360
710 mm	3L	<input type="radio"/>	M231420
		<input checked="" type="radio"/>	M231460
947 mm	4L	<input type="radio"/>	M231520
		<input checked="" type="radio"/>	M231560
1184 mm	5L	<input type="radio"/>	M231620
		<input checked="" type="radio"/>	M231660
1421 mm	6L	<input type="radio"/>	M231720
		<input checked="" type="radio"/>	M231760
2368 mm	10L	<input type="radio"/>	M231820
		<input checked="" type="radio"/>	M231860
2605 mm	11L	<input type="radio"/>	M231920
		<input checked="" type="radio"/>	M231960
4736 mm	20L	<input type="radio"/>	M232020
		<input checked="" type="radio"/>	M232060
1170 mm	1DL	<input type="radio"/>	M232120
		<input checked="" type="radio"/>	M232160
2340 mm	2DL	<input type="radio"/>	M232220
		<input checked="" type="radio"/>	M232260
4680 mm	4DL	<input type="radio"/>	M232320
		<input checked="" type="radio"/>	M232360

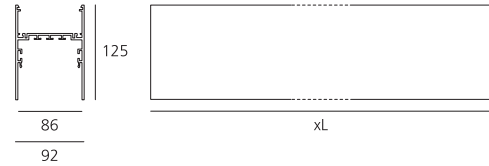
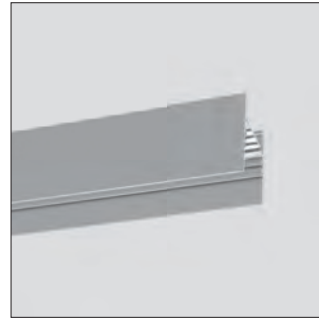

Accessories

	Color	Code
<p>End caps. (set of 2)</p>	<input type="radio"/> <input checked="" type="radio"/>	M194320 M194360
<p>Linear connector. (1 piece)</p>		M194500
<p>Ceiling fixing bracket. (1 piece)</p>		M232600
<p>Intermediate joint. To be used for combining spotlighting modules with fluorescent modules with dark light or diffusing emission.</p>	<input type="radio"/> <input checked="" type="radio"/>	M194620 M194660
<p>90° joint. To mechanically connect 2 modules on one same plane.</p>	<input type="radio"/> <input checked="" type="radio"/>	M181820 M181860
<p>Steel suspension cable. (1 piece). Length 2000 mm.</p>		M194700
<p>MV LV Suspension set with steel cable and power supply cable. Length 2000 mm.</p>		
<p>LV (3x1,5mm²). For powering LED RGB plates.</p>		M194800
<p>MV (5x1,5mm² + 2x0,5mm²). For powering fluorescent modules, white LED plates and accent modules.</p>		M194900

Line with fluorescent T16- diffuser modules

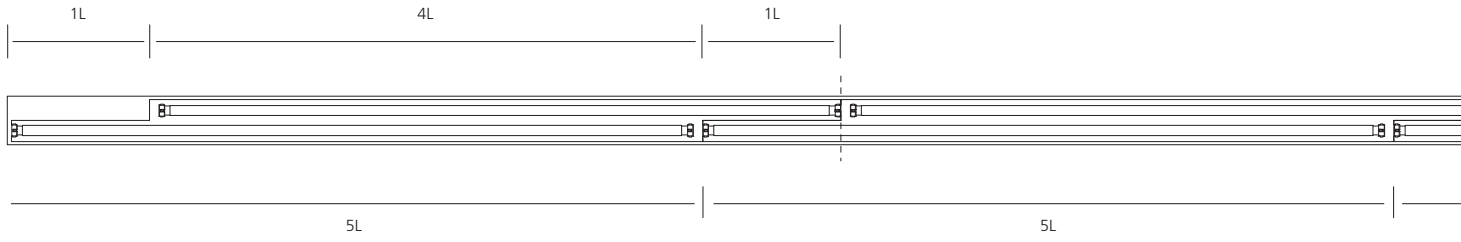

= (20L+1L) o (10L+11L)

Line with fluorescent T16-SLS diffuser modules

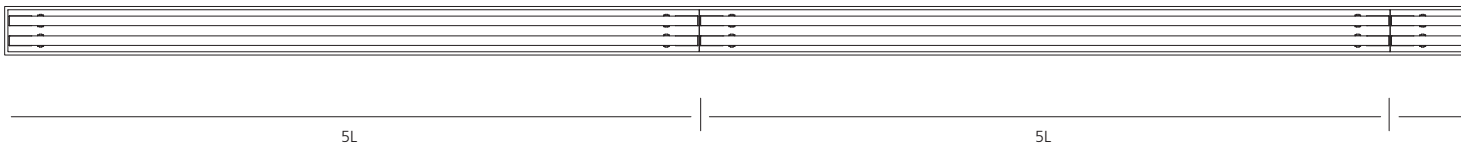

= (1x20L) o (2x10L) o (4x5L)

Mixed line with fluorescent T16-SLS diffuser modules and spotling/accent units.

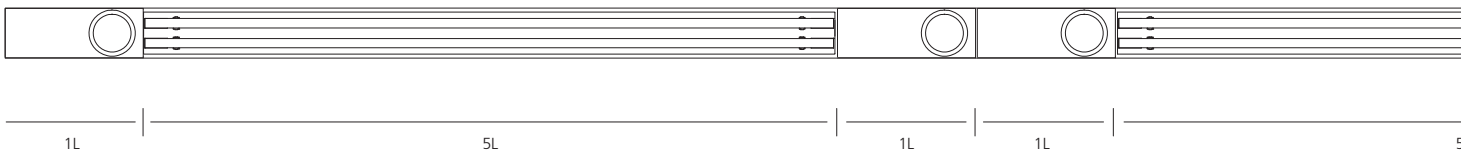

= (10L+4L) o (6L+2L+6L)

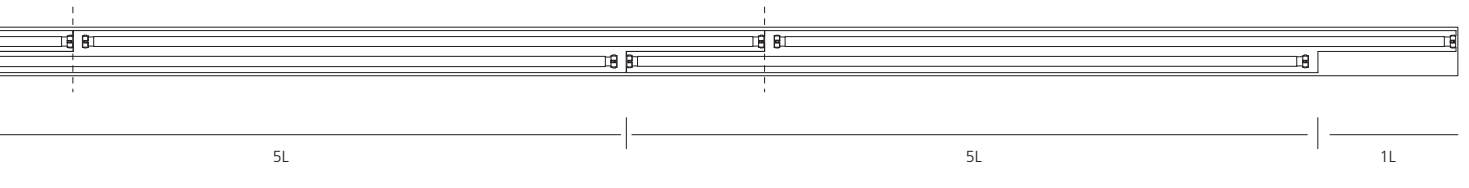

Nothing 86 System diffused emission

White LED direct emission

W	Length	CCT
23 W	1184 mm 5L	3000 K 4000 K
46 W	2368 mm 10L	3000 K 4000 K

non dimmable

Code
M232800
M232900
M237800
M237900

Dali-SwitchDim

Code
M232801
M232901
M237801
M237901

Integrated MV through-cabling.



RGB LED direct emission

W (LED)	Length	Code
18 W	1184 mm 5L	M233600

Code
M233600

Integrated LV through-cabling.

Power supply groups and lighting management kits are required. To be ordered separately.



Direct diffused emission T16 (G5)

W	Length	Code
2x54 W	1421 mm 6L	M233000

Code
M233000

Direct diffused emission T16 (G5)

W	Length	Code
2x28-54 W	1421 mm 6L	M233001

Code
M233001

Integrated MV through-cabling.



Direct diffused emission T16-SLS (G5)

W	Length	Code
2x54 W	1184 mm 5L	M233300

Code
M233300

Direct diffused emission T16 (G5)

W	Length	Code
2x28-54 W	1184 mm 5L	M233301

Code
M233301

Integrated MV through-cabling.



Indirect emission T16 (G5)

W	Length	Code
1x39 W	875 mm	M233100
2x39 W	1750 mm	M233200

Code
M233100
M233200

Upper screen in PMAA included.



Wired gear plates

650°

Nothing 86 System diffused emission

Diffuser for LED modules

Length

1184 mm	5L
1420 mm	6L
2368 mm	10L
2605 mm	11L
4736 mm	20L

Code

M235100
M235200
M235300
M235400
M235500



850°

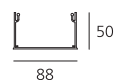

Nothing 86 LED White

direct LED

luminaire

24 W

Power	20 W	20 W	24 W	24 W
Flux	2940 lm	3075 lm	1730 lm	1810 m
CCT	3000 K	4000 K	3000 K	4000 K
CRI	=80 (typ.)			
Color tolerance	MacAdam 3SDCM			
Service life	L70(GK) > 50000h			
Efficiency			59%	59%
Efficacy	145 lm/W	153 lm/W	72 lm/W	75 lm/W

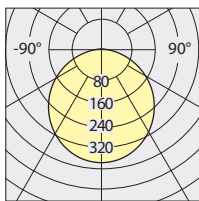

cd/klm

Values related to luminaire body L 1184 mm.

Diffuser for fluorescent modules

Length

1184 mm	5L
1421 mm	6L
2368 mm	10L
2605 mm	11L
4736 mm	20L

Code

M234500
M234600
M234700
M234800
M234900



650°

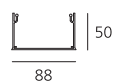
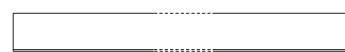

Direct T16 (G5)

Efficiency 46%

Direct T16-SLS (G5)

Efficiency 46%

28/54 W 2600/4450 lm

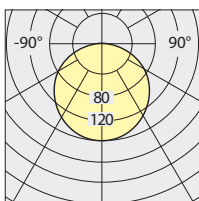

cd/klm

Indirect T16 (G5)

Efficiency 45%

39 W 3100 lm

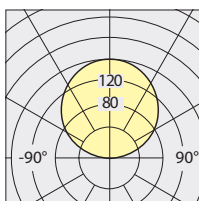

cd/klm

Nothing 86 System diffused emission prismatic

Wired gear plates

White LED direct emission

W	Length	CCT
24 W	1184 mm 5L	3000 K 4000 K
46 W	2368 mm 10L	3000 K 4000 K

non dimmable

Code
M232800
M232900
M237800
M237900

Dali-SwitchDim

Code
M232801
M232901
M237801
M237901

Integrated MV through-cablling.



Indirect emission T16 (G5)

W	Length
1x39 W	875 mm
2x39 W	1750 mm

non dimmable

Code
M233100
M233200

Upper screen in PMAA included.



650°

Indirect T16 (G5)

Efficiency 45%

39 W 3100 lm

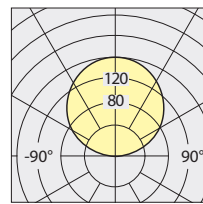

cd/klm

Diffuser for LED modules

Length
1184 mm 5L
2368 mm 10L

Code
M289800
M289900

24 W LED

3000 K

4000 K

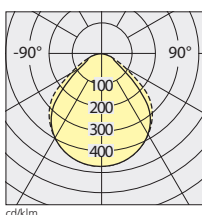

H	Ø	E _{Max}	E _M	H	Ø	E _{Max}	E _M
m	m	lux	lux	m	m	lux	lux
1	2,07	572	192	1	2,07	615	207
2	4,14	143	48	2	4,14	154	52
3	6,21	64	21	3	6,21	68	23
4	8,28	36	12	4	8,28	38	13
5	10,35	23	8	5	10,35	25	8

Values for luminaire body L 1184 mm.

Optics



850°

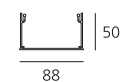
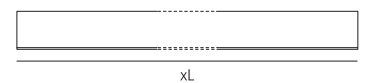

Nothing 86 System fluo direct emission dark-light

Wired gear plates

Direct emission T16 (G5)

non dimmable

W	Length	
1x54 W	1170 mm	1DL
2x54 W	2340 mm	2DL

Code
M233400
M233500

Direct emission T16 (G5)

Dali-SwitchDim

W	Length	
1x28-54 W	1170 mm	1DL
2x28-54 W	2340 mm	2DL

Code
M233401
M233501

Integrated MV through-cabling.



Indirect emission T16 (G5)

non dimmable

W	Length	
1x39 W	875 mm	
2x39 W	1750 mm	

Code
M233100
M233200

Upper screen in PMAA included.



650°

Indirect T16 (G5)

39 W 3100 lm

Efficiency 45%

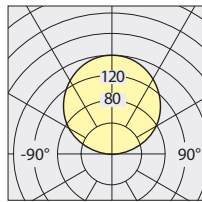

Optics

Dark Light Optics

Length	Code
1170 mm 1DL	M235000

Code
M235000

Direct T16 (G5)

28/54 W 2600/4450 lm

Efficiency 72%

UGR < 19		
2θ/2 = 88°	54 W	28 W
E ₀ (h 1m)	2095 lux	1130 lux
E ₀ (h 2m)	524 lux	283 lux

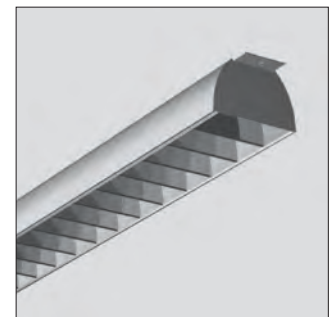
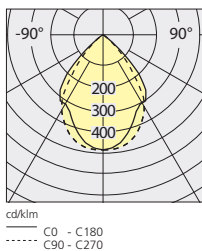

960°

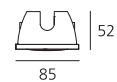
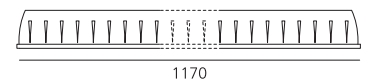

85

Nothing 86 System ceiling/suspension accent modules

Wired gear plates ● Black

LED (GU10)

W	Length	Color	Code
1x7 W	237 mm 1L	●	M234400

HIPAR51 (GX10)

W	Length	Color	Code
1x29 W	237 mm 1L	●	M234000

QR-CBC51 (GU5,3)

W	Length	Color	Code
1xmax35 W	237 mm 1L	●	M233900

HIT-TC-CE (GU6,5)

W	Length	Beam	Color	Code
1x20 W	2367 mm 1L	18°	●	M234200SP
		26°	●	M234200MFL
		40°	●	M234200FL

Integrated electronic power supply.
Integrated MV through-cablings.

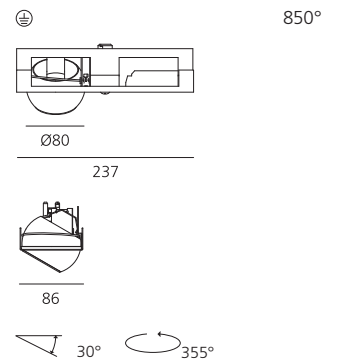

20 W/1000 lm Efficiency 60% α=18°

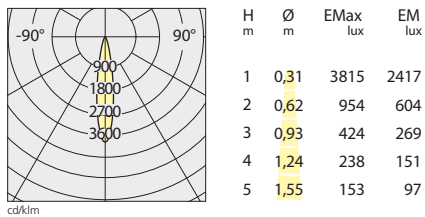

20 W/1000 lm Efficiency 58% α=26°

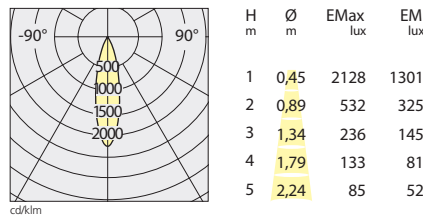

20 W/1000 lm Efficiency 73% α=40°

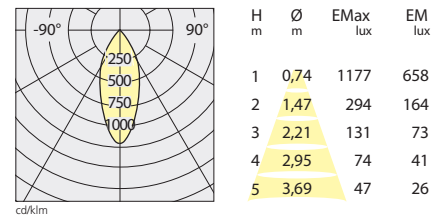

Indirect emission T16 (G5)

W	Length
1x39 W	875 mm
2x39 W	1750 mm

non dimmable

Code
M233100
M233200

Upper screen in PMAA included.

Indirect T16 (G5)

Efficiency 45%

39 W 3100 lm

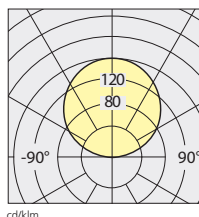



Power supply/light management system for LED*



Electronic power supply
IP67. Input voltage range:
90-264VAC / 47-63 VDC.
Output voltage: 48 VDC. Protection
against overcurrent, overvoltage,
short-circuit and overtemperature,
with automatic reactivation.

100 W
For feeding up to a total 90 W.
220x68x38 mm.

240 W
For feeding up to a total 225 W.
244x68x39 mm.

320 W
For feeding up to a total 300 W.
252x90x44 mm.



Control interface
It allows the management of LED rgb
groups of Nothing 86 System devices
through Dali or Dmx light manage-
ment systems (not included).

IP67



**Integrated sequencer for stand-alone
operation with predefined colour
sequence. Possibility of master-slave
configuration.**

IP20

IP67. Compactible DALI-Switch Dimm
310x168x90 mm.

IP67. Compactible DALI-Switch Dimm
or DMX.
310x168x90 mm.

IP20. Compactible DALI-Switch Dimm
Suitable for DIN rail mounting.
106x90x70 mm.

IP20. Compactible DALI-Switch Dimm
or DMX.
Suitable for DIN rail mounting.
106x90x70 mm.

For electrical scheme, please see page 380

Electrical components



Optional through-wiring.
(optional).
Required for configurations
including LV and MV pre-cabled
gear trays.

LV 237 mm

LV 1170/1184 mm

LV 1421mm

in the event of 'n' cabled
gear plates of 6 m. length,
the first 'N-1' will use optional
through-wiring L=1184,
whereas the last gear plate will use
an optional cable L=1421

LV 2340/2368 mm

MV 1184 mm

MV 2368 mm



Power supply kit.
Enables connection to the first pre-
wired gear tray of the initial module.
To be used only with ceiling-recessed
and ceiling-mounted installations.

LV (3xmax 1,5 mm²)
For powering LED RGB trays.

MV (7xmax 1,5 mm²)
For powering fluorescent modules,
white LED plates and accent modules.

Accessories



Closure panel.
Length 237 mm (1L).

Color
●

Code
M232710

Closure screens for 90° joints



**Junction to be fitted for modules
at 90° on the same plane.**
Compatible with the junction
for the same plane.

For continuity between LED diffused
emission modules and spot
modules.

Code

M167500

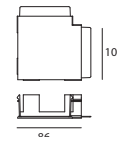

For continuity between
fluo diffused emission modules.

M167600

For continuity between
fluo dark light emission modules.

M167700

Light sources



**Fluorescent tube
T16-SEAMLESS (G5)**
1 piece

28 W (3000 K)

28 W (4000 K)

54 W (3000 K)

54 W (4000 K)

M004810

M004815

M004800

M004805

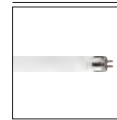

Fluorescent tube T16 (G5)
1 piece

28 W (3000 K)-direct

28 W (4000 K)-direct

54 W (3000 K)-direct

54 W (4000 K)-direct

39 W (3000 K)-indirect

39 W (4000 K)-indirect

M004380

M004325

M004350

M004355

M004380

M004381

Code

M075000

M075100

M076100

M077000

M077100

M077200

M077300

Code

M211700

M198800

M211600

M199000

M198700

M198900

M073230

M073240

Nothing 86 LED management (LV): electrical scheme

Stand-alone 1 *

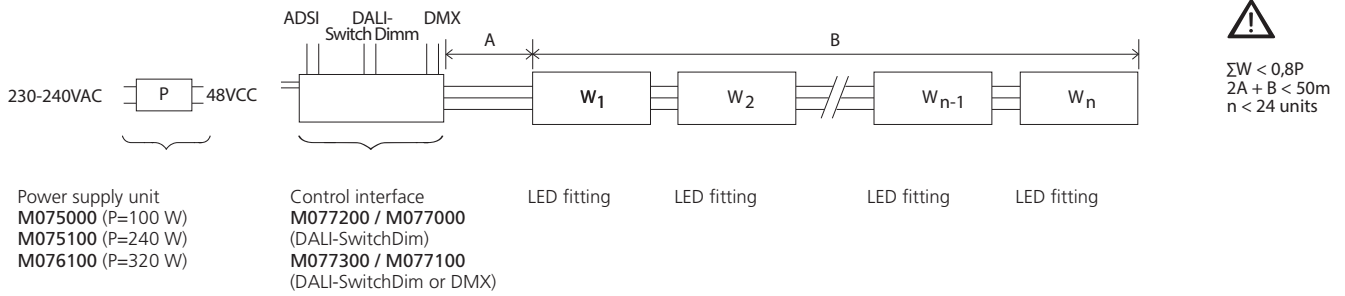

Stand-alone 2 *

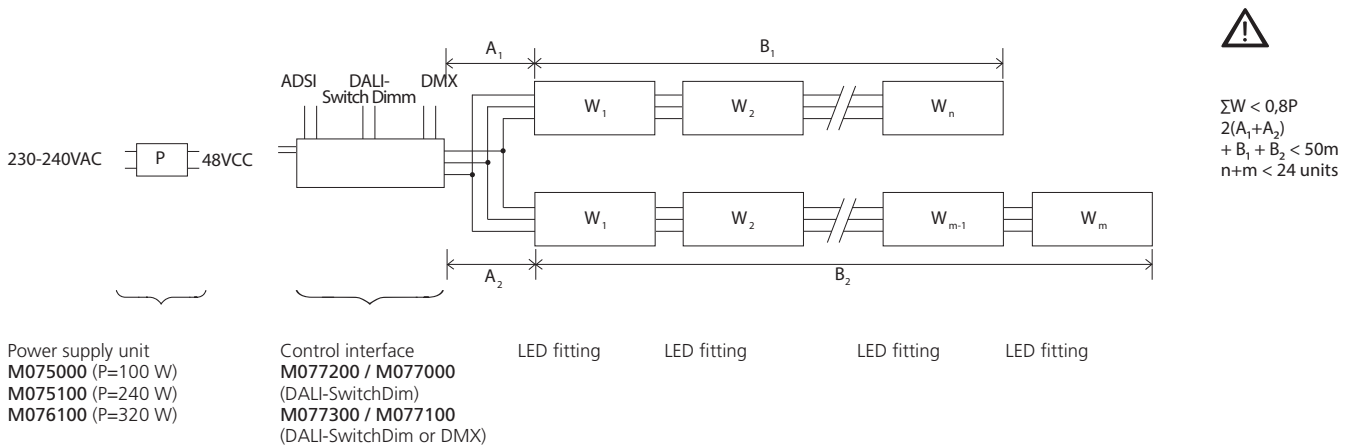

* Maximum values.
For lighting design, please use data available on the control interface manual.

Master-slave *

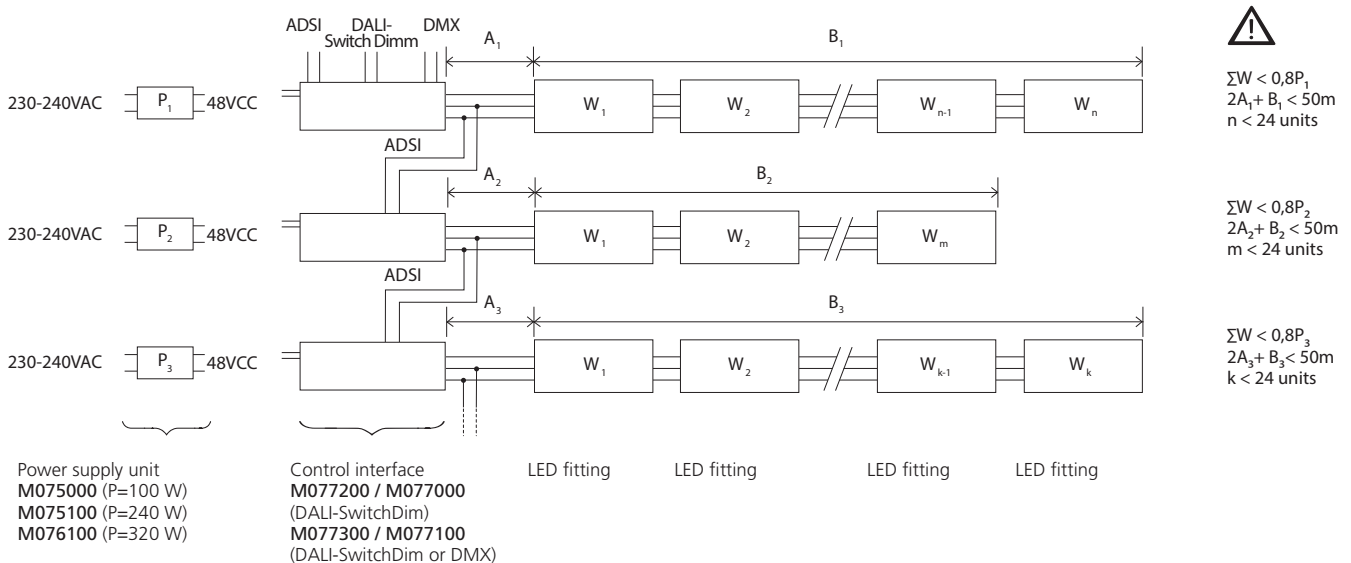

Nothing 86 Stand alone

Ernesto Gismondi
2013





Nothing 86 Stand-alone suspension white LED diffused emission

White Gloss anodised

Direct emission

LED White					non dimmable	Dali-SwitchDim
W	Length	Flux	CCT	Color	Code	Code
24 W	1188 mm	1730 lm	3000 K	<input type="radio"/>	M202120	M202121
				<input checked="" type="radio"/>	M202160	M202161
	1188 mm	1810 lm	4000 K	<input type="radio"/>	M202220	M202221
46 W	2372 mm	3460 lm	3000 K	<input type="radio"/>	M202260	M202261
				<input checked="" type="radio"/>	M202320	M202321
	2372 mm	3620 lm	4000 K	<input type="radio"/>	M202360	M202361
				<input checked="" type="radio"/>	M202420	M202421
			<input type="radio"/>	M202460	M202461	

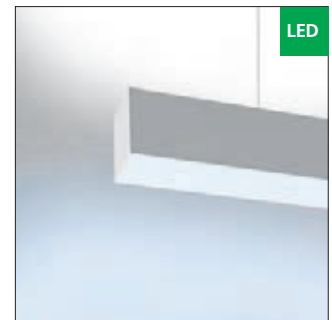

Direct + indirect emission

LED White + fluo				non dimmable	Dali-SwitchDim*
W	Length	CCT (LED)	Color	Code	Code
24 W	1188 mm	3000 K	<input type="radio"/>	M202520	M202521
			<input checked="" type="radio"/>	M202560	M202561
	1188 mm	4000 K	<input type="radio"/>	M202620	M202621
			<input checked="" type="radio"/>	M202660	M202661
46 W	2372 mm	3000 K	<input type="radio"/>	M202720	M202721
			<input checked="" type="radio"/>	M202760	M202761
	2372 mm	4000 K	<input type="radio"/>	M202820	M202821
			<input checked="" type="radio"/>	M202860	M202861

IP20 850° (direct)
650° (direct+indirect)

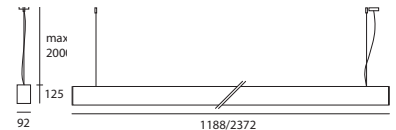

* Direct emission dimmable only.
Upper screen in PMAA included.

Nothing 86 Stand-alone ceiling LED white diffused emission

Direct emission

LED White					non dimmable	Dali-SwitchDim
W	Length	Flux	CCT	Color	Code	Code
24 W	1188 mm	1730 lm	3000 K	<input type="radio"/>	M202920	M202921
				<input checked="" type="radio"/>	M202960	M202961
	1188 mm	1810 lm	4000 K	<input type="radio"/>	M203020	M203021
46 W	2372 mm	2928 lm	3000 K	<input type="radio"/>	M203060	M203061
				<input checked="" type="radio"/>	M203120	M203121
	2372 mm	3120 lm	4000 K	<input type="radio"/>	M203160	M203161
				<input checked="" type="radio"/>	M203220	M203221
			<input type="radio"/>	M203260	M203261	

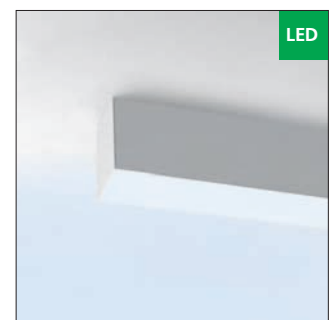

IP20 850°

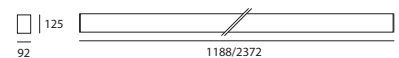

Nothing 86 LED White	LED direct		luminaire		24 W	Indirect T16 (G5)	39 W	3100 lm
	Power	20 W	20 W	24 W	24 W		Efficiency 45%	
Flux	2940 lm	3075 lm	1730 lm	1810 lm				
CCT	3000 K	4000 K	3000 K	4000 K				
CRI	=80 (typ.)							
Color tolerance	MacAdam 3SDCM							
Service life	L70(6K) > 50000h							
Efficiency			59%	59%				
Efficacy	145 lm/W	153 lm/W	72 lm/W	75 lm/W				

Values for luminaire body L 1188 mm.

Nothing 86 System Stand-alone suspension fluo diffused emission

White Gloss anodised

Direct emission

T16-SLS (G5)			non dimmable
W	Length	Color	Code
2x54 W	1188 mm	<input type="radio"/>	M235620
		<input checked="" type="radio"/>	M235660
4x54 W	2372 mm	<input type="radio"/>	M235720
		<input checked="" type="radio"/>	M235760

T16-SLS (G5)			Dali-SwitchDim
W	Length	Color	Code
2x28-54 W	1188 mm	<input type="radio"/>	M235621
		<input checked="" type="radio"/>	M235661
4x28-54 W	2372 mm	<input type="radio"/>	M235721
		<input checked="" type="radio"/>	M235761

Direct + indirect emission

T16-SLS (G5)			non dimmable
W	Length	Color	Code
2x54 W (T16-SLS (G5))	1188 mm	<input type="radio"/>	M235820
+ 1x39 W (T16 (G5))		<input checked="" type="radio"/>	M235860
4x54 W (T16-SLS (G5))	2372 mm	<input type="radio"/>	M235920
+ 2x39 W (T16 (G5))		<input checked="" type="radio"/>	M235960

T16-SLS (G5)			Dali-SwitchDim*
W	Length	Color	Code
2x28-54 W (T16-SLS (G5))	1188 mm	<input type="radio"/>	M235821
+ 1x39 W (T16 (G5))		<input checked="" type="radio"/>	M235861
4x28-54 W (T16-SLS (G5))	2372 mm	<input type="radio"/>	M235921
+ 2x39 W (T16 (G5))		<input checked="" type="radio"/>	M235961

* Direct emission dimmable only.
Upper screen in PMAA included.

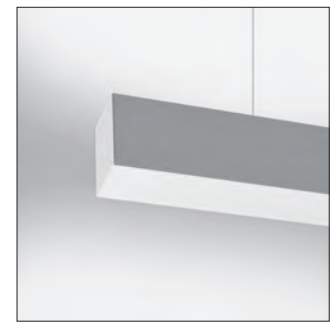

IP20 650°

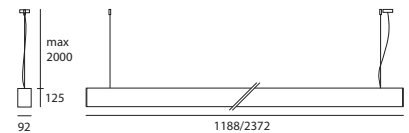

Nothing 86 System Stand-alone wall/ceiling fluo diffused emission

T16-SLS (G5)			non dimmable
W	Length	Color	Code
2x54 W	1188 mm	<input type="radio"/>	M236020
		<input checked="" type="radio"/>	M236060
4x54 W	2372 mm	<input type="radio"/>	M236120
		<input checked="" type="radio"/>	M236160

T16-SLS (G5)			Dali-SwitchDim
W	Length	Color	Code
2x28-54 W	1188 mm	<input type="radio"/>	M236021
		<input checked="" type="radio"/>	M236061
4x28-54 W	2372 mm	<input type="radio"/>	M236121
		<input checked="" type="radio"/>	M236161



IP20 650°

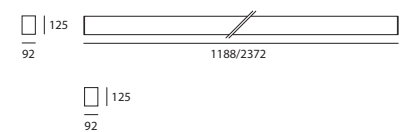

Direct T16(G5)

Efficiency 46%

Direct T16-SLS (G5)

Efficiency 46%

28/54 W 2600/4450 lm

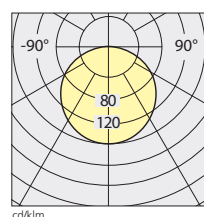

cd/klm

Indirect T16 (G5)

Efficiency 45%

39 W 3100 lm

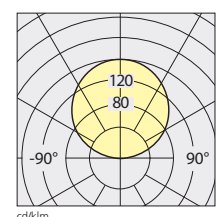

cd/klm

Nothing 86 System Stand-alone suspension LED emission prismoptic

White Gloss anodised

Direct emission

LED White

W	Length	Flux	CCT	Color
24 W	1188 mm	1283 lm	3000 K	<input type="radio"/>
				<input checked="" type="radio"/>
	1188 mm	1380 lm	4000 K	<input type="radio"/>
				<input checked="" type="radio"/>
46 W	2372 mm	2566 lm	3000 K	<input type="radio"/>
				<input checked="" type="radio"/>
	2372 mm	2760 lm	4000 K	<input type="radio"/>
				<input checked="" type="radio"/>

non dimmable

Code
M2900W20
M2900W60
M2900N20
M2900N60
M2901W20
M2901W60
M2901N20
M2901N60

Dali-SwitchDim

Code
M2900W21
M2900W61
M2900N21
M2900N61
M2901W21
M2901W61
M2901N21
M2901N61

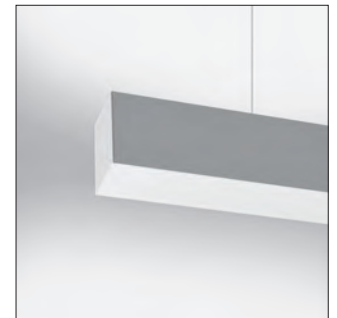

Direct + indirect emission

LED White + fluo

W	Length	CCT (LED)	Color
24 W	1188 mm	3000 K	<input type="radio"/>
			<input checked="" type="radio"/>
1x39 W (T16 (G5))	1188 mm	4000 K	<input type="radio"/>
			<input checked="" type="radio"/>
46 W	2372 mm	3000 K	<input type="radio"/>
			<input checked="" type="radio"/>
2x39 W (T16 (G5))	2372 mm	4000 K	<input type="radio"/>
			<input checked="" type="radio"/>

non dimmable

Code
M2902W20
M2902W60
M2902N20
M2902N60
M2903W20
M2903W60
M2903N20
M2903N60

Dali-SwitchDim*

Code
M2902W21
M2902W61
M2902N21
M2902N61
M2903W21
M2903W61
M2903N21
M2903N61

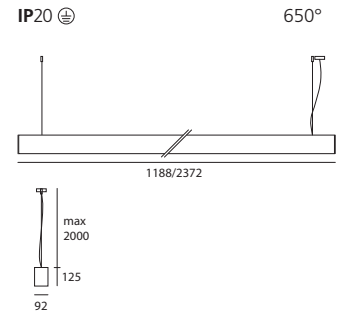

* Direct emission dimmable only. Upper screen in PMAA included.

Nothing 86 System Stand-alone wall/ceiling LED emission prismoptic

Direct emission

LED White

W	Length	Flux	CCT	Color
24 W	1188 mm	1283 lm	3000 K	<input type="radio"/>
				<input checked="" type="radio"/>
	1188 mm	1380 lm	4000 K	<input type="radio"/>
				<input checked="" type="radio"/>
46 W	2372 mm	2566 lm	3000 K	<input type="radio"/>
				<input checked="" type="radio"/>
	2372 mm	2760 lm	4000 K	<input type="radio"/>
				<input checked="" type="radio"/>

non dimmable

Code
M2904W20
M2904W60
M2904N20
M2904N60
M2905W20
M2905W60
M2905N20
M2905N60

Dali-SwitchDim

Code
M2904W21
M2904W61
M2904N21
M2904N61
M2905W21
M2905W61
M2905N21
M2905N61



IP20 650°

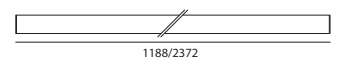

125
92

23 W LED

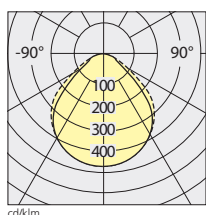

3000 K

H m	Ø m	EMax lux	EM lux
1	2,07	572	192
2	4,14	143	48
3	6,21	64	21
4	8,28	36	12
5	10,35	23	8

4000 K

H m	Ø m	EMax lux	EM lux
1	2,07	615	207
2	4,14	154	52
3	6,21	68	23
4	8,28	38	13
5	10,35	25	8

Indirect T16 (G5)

Efficiency 45%

39 W

3100 lm

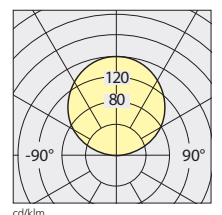

Values related to luminaire body L 1184 mm.

Nothing 86 System Stand-alone suspension fluo dark light emission

White Gloss anodised

Direct emission

T16 (G5)			non dimmable
W	Length	Color	Code
1x54 W	1174 mm	<input type="radio"/>	M226920
		<input checked="" type="radio"/>	M226960
2x54 W	2348 mm	<input type="radio"/>	M227020
		<input checked="" type="radio"/>	M227060

T16 (G5)			Dali-SwitchDim
W	Length	Color	Code
1x28-54 W	1174 mm	<input type="radio"/>	M226921
		<input checked="" type="radio"/>	M226961
2x28-54 W	2348 mm	<input type="radio"/>	M227021
		<input checked="" type="radio"/>	M227061

Direct + indirect emission

T16-SLS (G5)			non dimmable
W	Length	Color	Code
1x54 W (T16-SLS (G5))	1174 mm	<input type="radio"/>	M227120
+ 1x39 W (T16 (G5))		<input checked="" type="radio"/>	M227160
2x54 W (T16-SLS (G5))	2348 mm	<input type="radio"/>	M227220
+ 2x39 W (T16 (G5))		<input checked="" type="radio"/>	M227260

T16-SLS (G5)			Dali-SwitchDim*
W	Length	Color	Code
1x28-54 W (T16-SLS (G5))	1174 mm	<input type="radio"/>	M227121
+ 1x39 W (T16 (G5))		<input checked="" type="radio"/>	M227161
2x28-54 W (T16-SLS (G5))	2348 mm	<input type="radio"/>	M227221
+ 2x39 W (T16 (G5))		<input checked="" type="radio"/>	M227261

* Direct emission dimmable only.
Upper screen in PMAA included.



IP20 960°

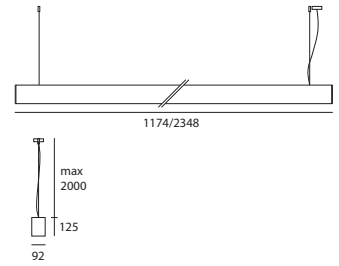

Nothing 86 System Stand-alone wall/ceiling fluo dark light emission

T16 (G5)			non dimmable
W	Length	Color	Code
1x54 W	1174 mm	<input type="radio"/>	M228720
		<input checked="" type="radio"/>	M228760
2x54 W	2348 mm	<input type="radio"/>	M228820
		<input checked="" type="radio"/>	M228860

T16 (G5)			Dali-SwitchDim
W	Length	Color	Code
1x28-54 W	1174 mm	<input type="radio"/>	M228721
		<input checked="" type="radio"/>	M228761
2x28-54 W	2348 mm	<input type="radio"/>	M228821
		<input checked="" type="radio"/>	M228861



IP20 960°

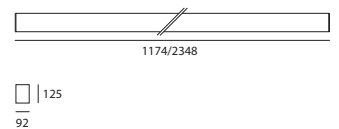

Direct T16 (G5)

Efficiency 72%

UGR < 19		
2θ/2 = 88°	54 W	28 W
E ₀ (h 1m)	2095 lux	1130 lux
E ₀ (h 2m)	524 lux	283 lux

28/54 W 2600/4450 lm

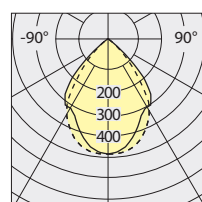

cd/klm
— C0 - C180
..... C90 - C270

Indirect T16 (G5)

Efficiency 45%

39 W 3100 lm

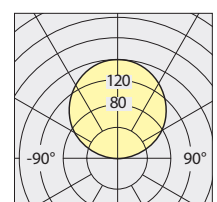

cd/klm

Nothing 86 Stand-alone suspension RGB LED diffused emission

White Gloss anodised

Direct emission

LED RGB

Dali dimmable

W	Length	Color	Code
21 W	1188 mm	<input type="radio"/>	M228120
		<input checked="" type="radio"/>	M228160
42 W	2372 mm	<input type="radio"/>	M228220
		<input checked="" type="radio"/>	M228260

Uses 3 dali addresses.

Direct + indirect emission

LED RGB

Dali dimmable*

W	Length	Color	Code
21 W(LED RGB)	1188 mm	<input type="radio"/>	M228320
1x39 W (T16 (G5))		<input checked="" type="radio"/>	M228360
42 W (LED RGB)	2372 mm	<input type="radio"/>	M228420
1x39 W (T16 (G5))		<input checked="" type="radio"/>	M228460

* Direct emission dimmable only.
Uses 3 dali addresses.
Upper screen in PMAA included.

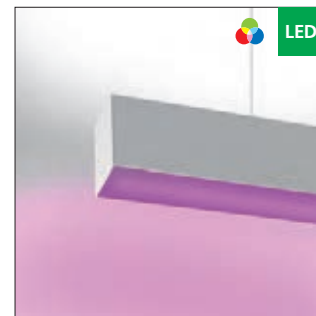

IP20 850° (direct)
650° (direct+indirect)

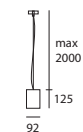
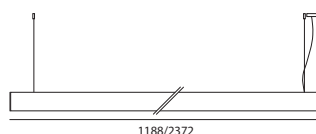

Nothing 86 Stand-alone wall/ceiling RGB LED diffused emission

LED RGB

Dali dimmable

W	Length	Color	Code
21 W	1188 mm	<input type="radio"/>	M229320
		<input checked="" type="radio"/>	M229360
42 W	2372 mm	<input type="radio"/>	M229420
		<input checked="" type="radio"/>	M229460

Uses 3 dali addresses.

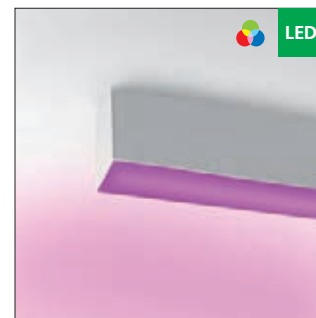

IP20 850°

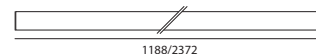

Indirect T16 (G5)

39 W 3100 lm

Efficiency 45%

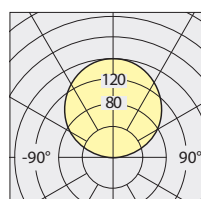

cd/klm

Light sources



Fluorescent tube T16-SEAMLESS (G5)
1 piece

- 28 W (3000 K)
- 28 W (4000 K)
- 54 W (3000 K)
- 54 W (4000 K)

Code

- M004810
- M004815
- M004800
- M004805

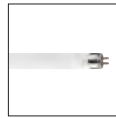

Fluorescent tube T16 (G5)
1 piece

- 28 W (3000 K)
- 28 W (4000 K)
- 54 W (3000 K)
- 54 W (4000 K)
- 39 W (3000 K)
- 39 W (4000 K)

Code

- M004380
- M004325
- M004350
- M004355
- M004380
- M004381





In Incipit, a single manufactured piece results in a well-calibrated combination of optical, mechanical, and thermal principles - the mainstays of the vast literature on light. Its design is minimal and no-frills. The vertical spokes have a mechanical function and also play a crucial role in conducting of the heat generated by the lighting source.

Aluminium-finished version ensure compliance with the UGR factor (<19) and a luminance of $<3000\text{cd}/\text{m}^2$ between 65° and 85° , with medium-aperture beams and high yields, which makes the appliance suited for work environments.



Incipit



- An aluminium body, featuring alternating vertical and horizontal elements, accommodates the LED.
- The horizontal bands work as optical sectors, appropriately calibrated vs. each other.
- The intertwined vertical and horizontal elements are the result of accurate optical and technological feasibility research for die casting production. They also promote air circulation when the appliance is arranged both vertically and horizontally, and allow natural ventilation by convection in all possible usage configurations.
- Calibration of this structure, in both the small and large version, results in optimal optical darklighting and downlighting performance, thus ensuring high visual comfort.
- A small-sized mixing chamber ensures the controlled direct emission of light rays.
- The optical performance of its mechanical surfaces is a direct result of the production process, which includes the optional finishing of surfaces either with subsequent processing finish or with white paint.
- The white version, with wide-aperture beams, is suited for soft downlighting. The diffusing power of the white surfaces ensures minimal leakage of light emission from within the mesh to give a luminous footprint to the body.

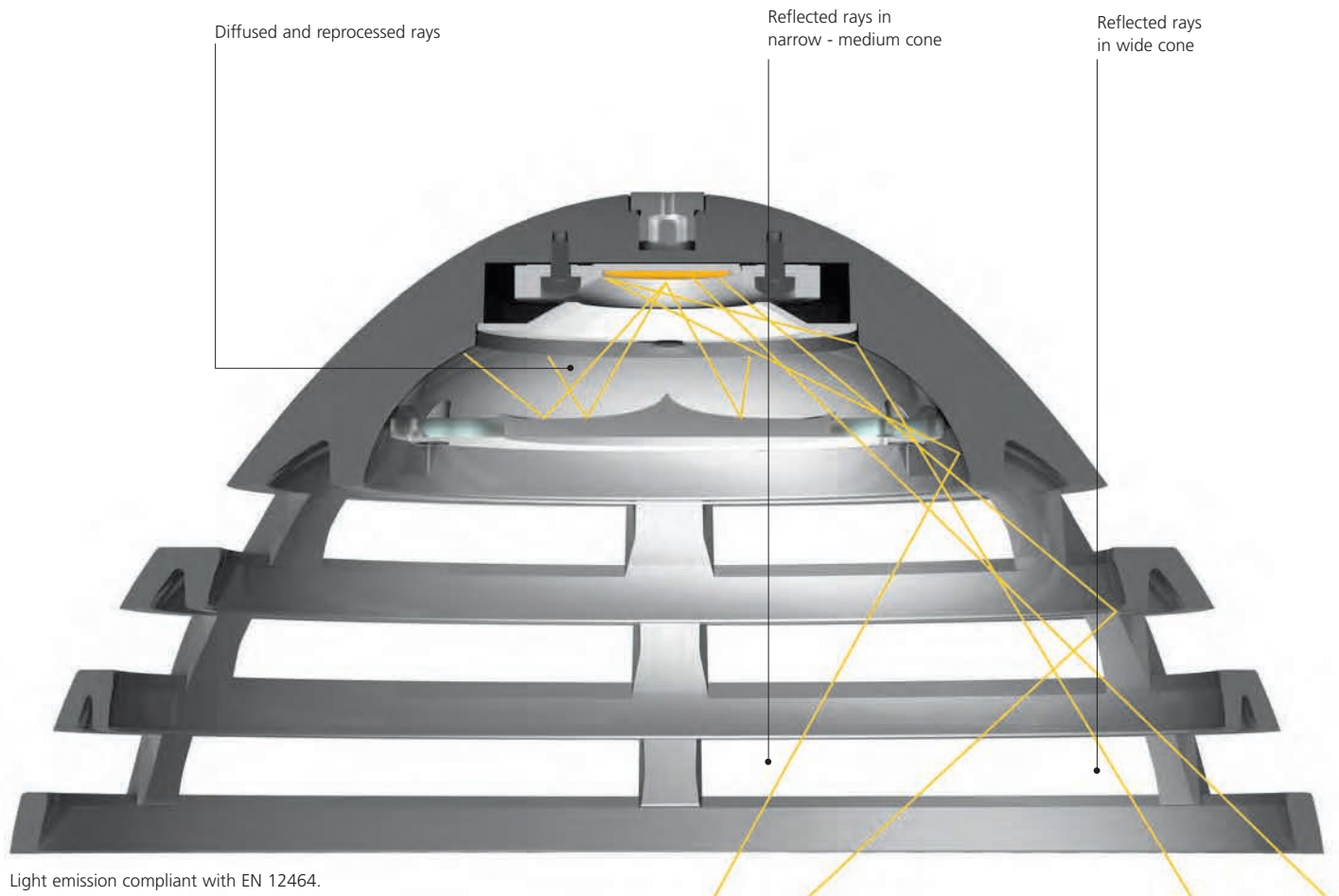

Light emission compliant with EN 12464.

- UGR < 19
- Luminance < 3000 cd/m² @ 65° (Aluminium version)

PATENT PENDING

1 Mechanic

More with less

2 Optic

Two optic performances

3 Thermal

Structure, optic and heat sink
in one light engine

Incipit 214

White



Polished Aluminum



Suspension

W	Weight	Beam	Flux	CCT	Color
29 W	1,50 kg	102°	2073 lm	3000 K	○
		56°	2053 lm	3000 K	●

Push dimm

Code
M3075W20
M3075W00

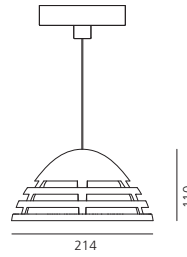

IP20

220/240Vac 50/60Hz electronic ballast included

Ceiling

W	Weight	Beam	Flux	CCT	Color
29 W	1,50 kg	102°	2073 lm	3000 K	○
		56°	2053 lm	3000 K	●

Push dimm

Code
M3085W20
M3085W00

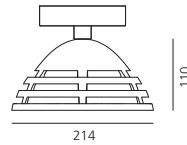

IP20

220/240Vac 50/60Hz electronic ballast included

Incipit 214 - white

LED luminaire

29 W

3000 K

$\alpha=102^\circ$

Power	25 W	29 W
Flux	2718 lm	2073 lm
CCT	3000 K	3000 K
CRI	=80 (min.)	
Color tolerance	MacAdam 2SDCM	
Service life	L70(9K)>50000h	
Beam		102°
Efficiency		77%
Efficacy	109 lm/W	71 lm/W

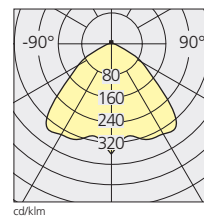

H m	Ø m	EMax lux	EM lux
1	2,46	757	257
2	4,91	189	64
3	7,37	84	29
4	9,83	47	16
5	12,28	30	10

Incipit 214 - polished

LED luminaire

29 W

3000 K

$\alpha=56^\circ$

Power	25 W	29 W
Flux	2718 lm	2053 lm
CCT	3000 K	3000 K
CRI	=80 (min.)	
Color tolerance	MacAdam 2SDCM	
UGR	<19	
Service life	L70(9K)>50000h	
Beam		56°
Efficiency		75%
Efficacy	109 lm/W	71 lm/W

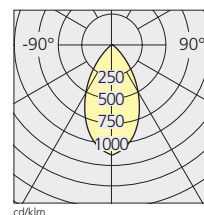

H m	Ø m	EMax lux	EM lux
1	1,08	2184	1126
2	2,16	546	281
3	3,25	243	125
4	4,33	137	70
5	5,41	87	45

Incipit

White Polished Aluminum

Suspension						Push dimm	
W	Weight	Beam	Flux	CCT	Color	Code	
40 W	3,50 kg	144°	4016 lm	3000 K	<input type="radio"/>	M3072W20	
		38°	3180 lm	3000 K	<input checked="" type="radio"/>	M3072W00	

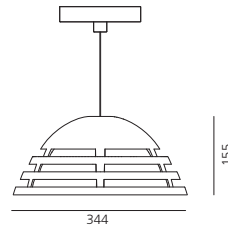

IP20

220/240Vac 50/60Hz electronic ballast included

Ceiling						Push dimm	
W	Weight	Beam	Flux	CCT	Color	Code	
40 W	3,50 kg	144°	4016 lm	3000 K	<input type="radio"/>	M3082W20	
		38°	3180 lm	3000 K	<input checked="" type="radio"/>	M3082W00	

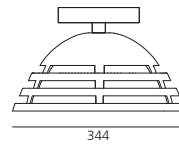

IP20

220/240Vac 50/60Hz electronic ballast included

Incipit - white	LED	luminaire
Power	40 W	40 W
Flux	4525 lm	4016 lm
CCT	3000 K	3000 K
CRI	=80 (min.)	
Color tolerance	MacAdam 2SDCM	
Service life	L70(9K)>50000h	
Beam		144°
Efficiency		88%
Efficacy	125 lm/W	100 lm/W

40 W 3000 K $\alpha=144^\circ$

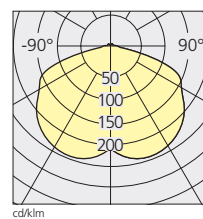

H	Ø	EMax	EM
m	m	lux	lux
1	6,12	900	92
2	12,25	225	23
3	18,37	100	10
4	24,50	56	6
5	30,62	36	4

Incipit - polished	LED	luminaire
Power	40 W	40 W
Flux	4525 lm	3180 lm
CCT	3000 K	3000 K
CRI	=80 (min.)	
Color tolerance	MacAdam 2SDCM	
UGR	<19	
Service life	L70(9K)>50000h	
Beam		38°
Efficiency		70%
Efficacy	125 lm/W	67 lm/W

40 W 3000 K $\alpha=38^\circ$

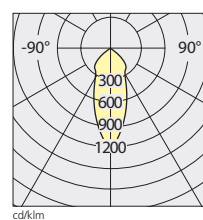

H	Ø	EMax	EM
m	m	lux	lux
1	0,68	3936	2194
2	1,35	984	548
3	2,03	437	244
4	2,71	246	137
5	3,38	157	88

Eggboard

Giacobone & Roj - CMR Project
2014

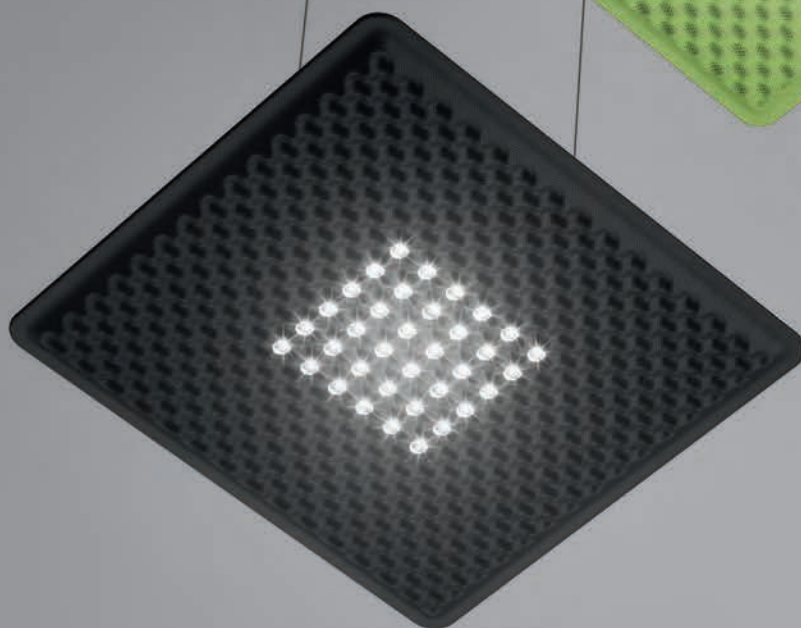
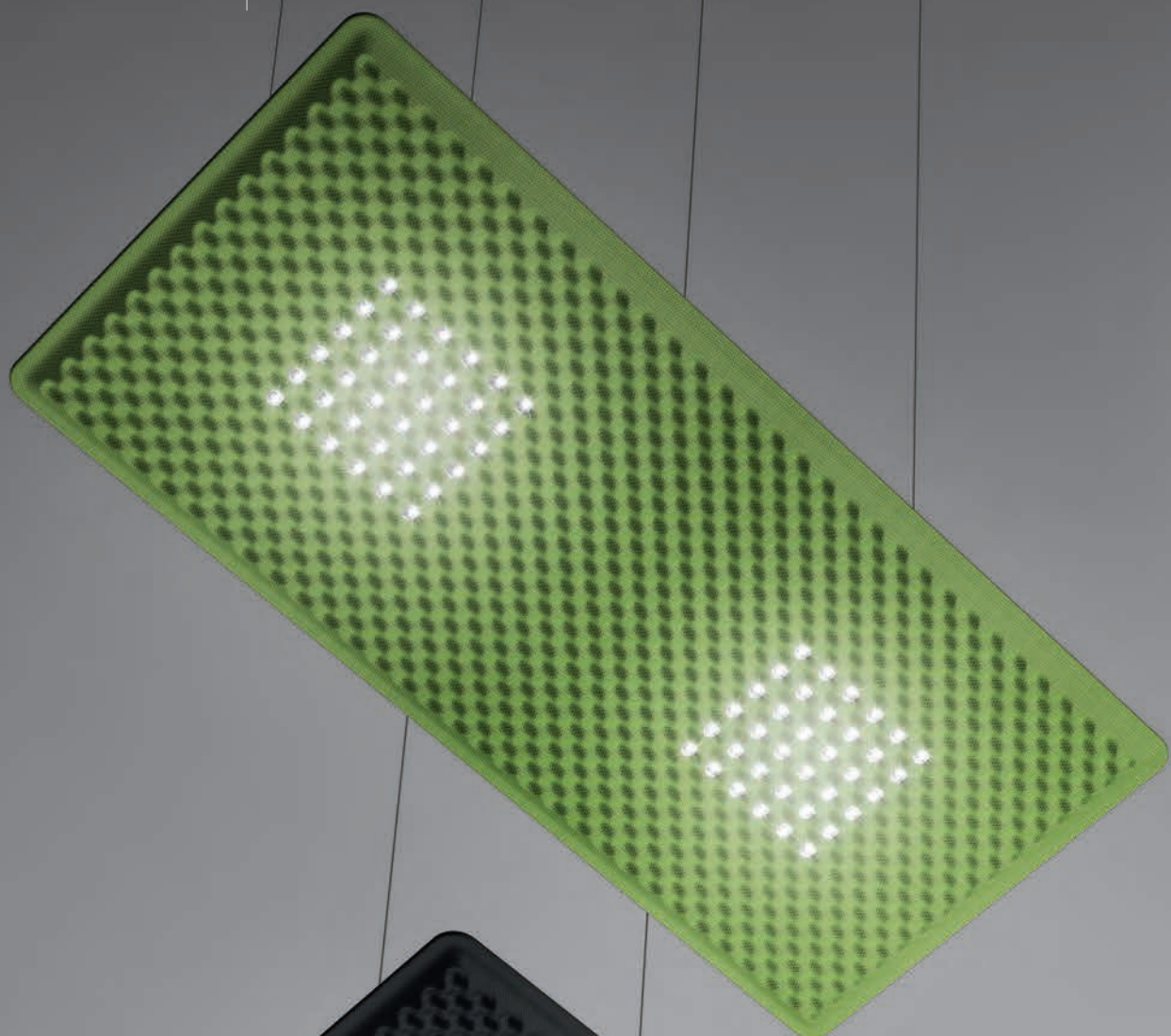

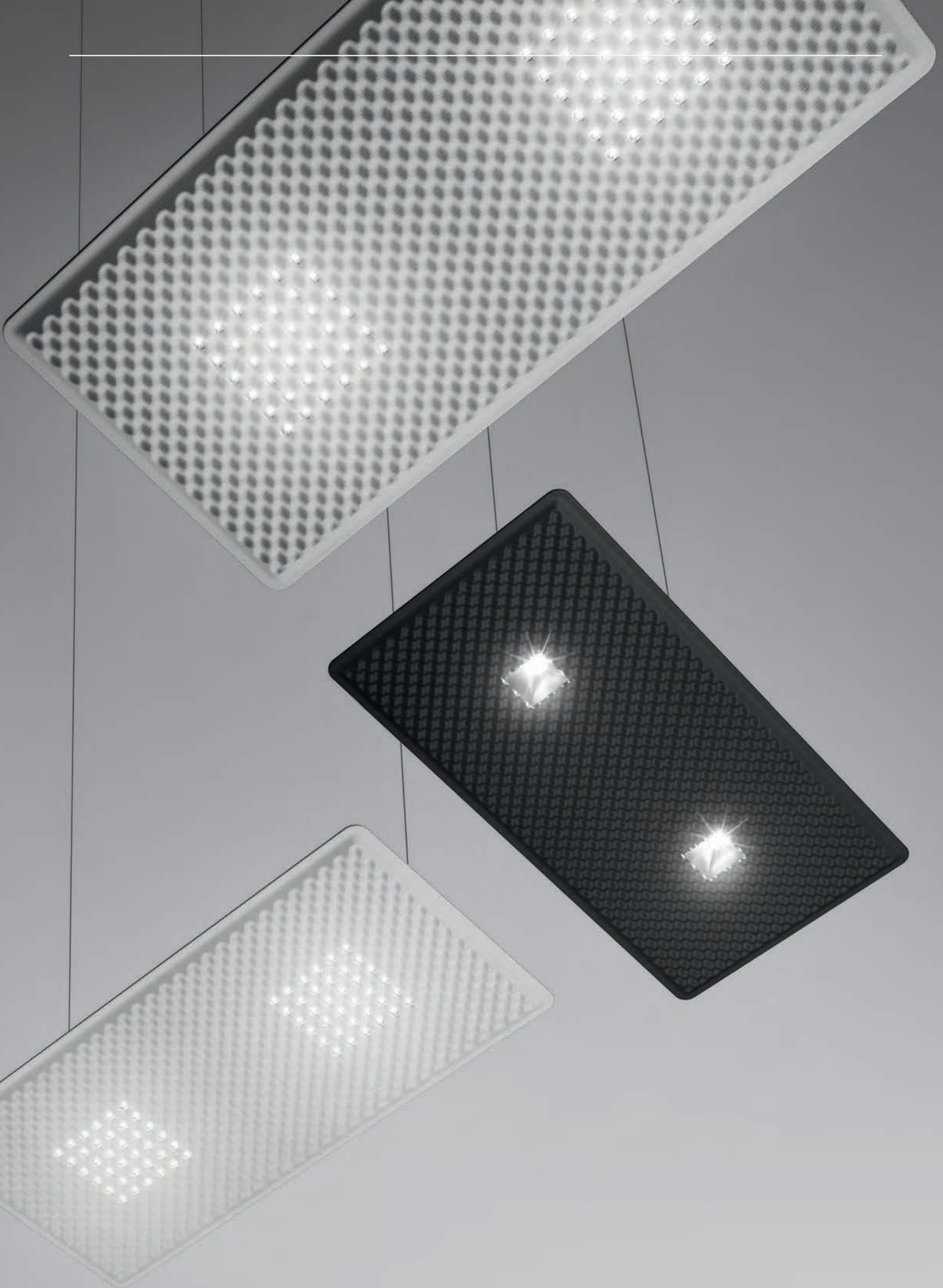

Eggboard

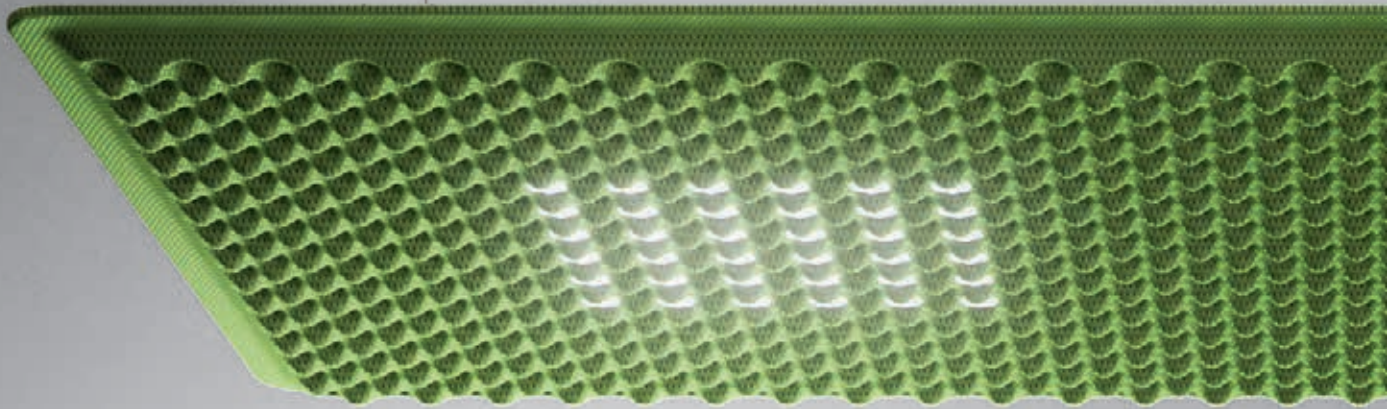

- Suspension appliance with sound-absorbing properties ensured by an unusual sinusoidal cross-section design of the lower surface and the use of a sound-absorbing material
- Acoustic efficiency is ensured within a limited space by positioning at approximately one metre above the head of the speaker and listener
- Direct emission: a board with a high number of low-voltage LEDs ensures maximum lighting comfort
- Reflectors can be rotated for use on single or counterposed double desk.
- Colour temperature 3000K or 4000 K
- Complies with the norms on office activities that involve the use of video-terminals (UGR<19).
- Available in 3 colours (white, grey, green) and 2 different sizes (1600X800mm - 800X800mm)

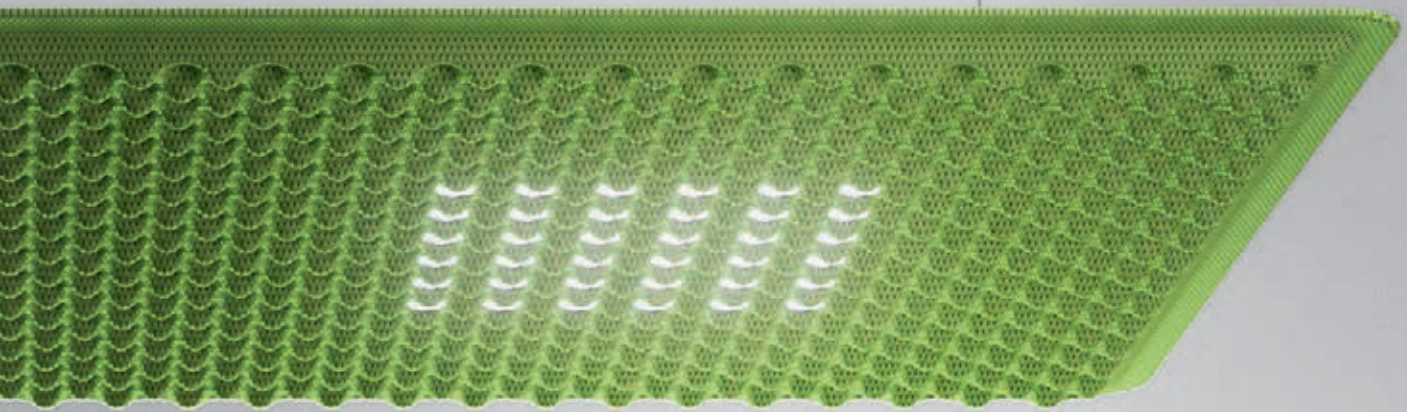

Eggboard acoustic panel

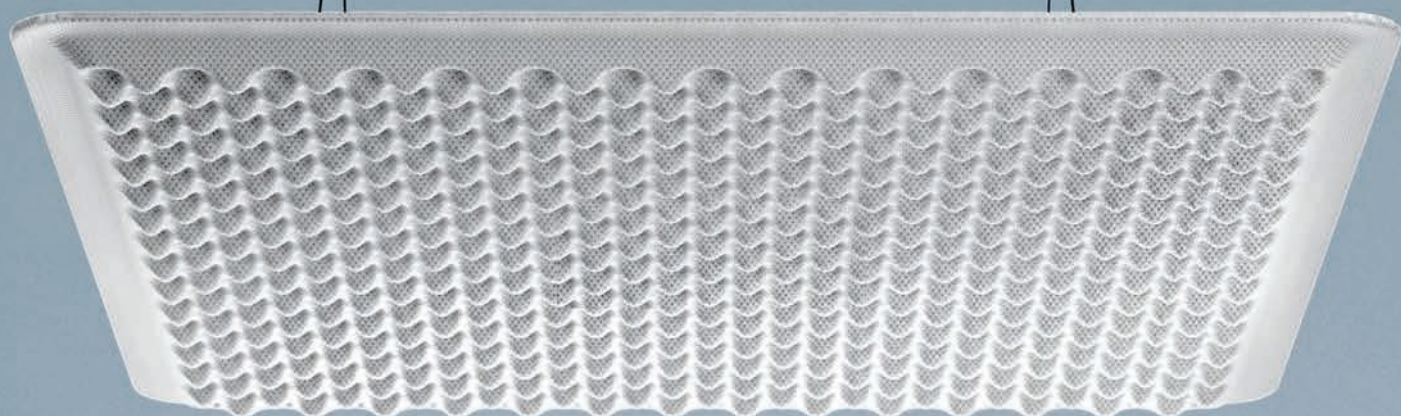

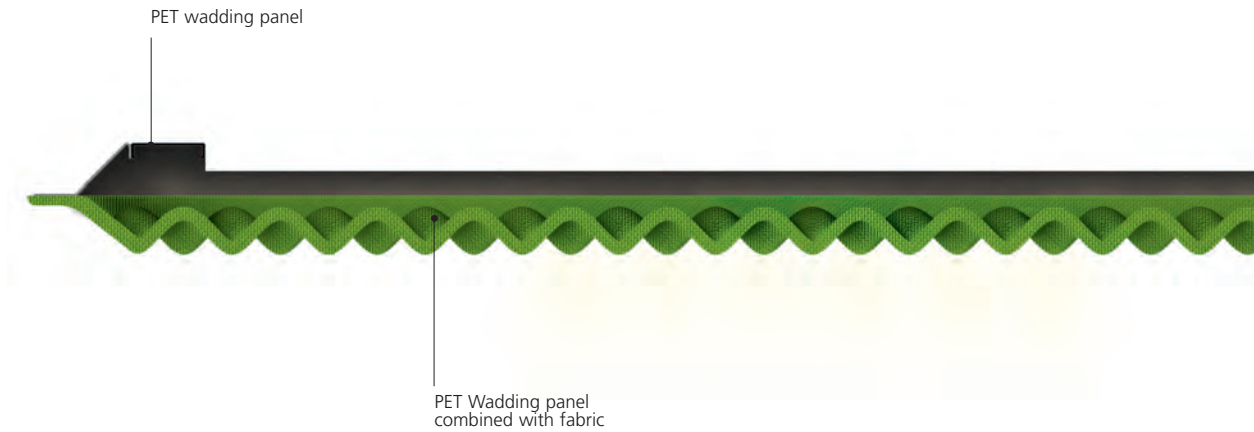

The sound-absorbing material acts by reducing the reverberation time (i.e. the time required to reduce any noise inside the room by 60 db, so as to ensure that any echoes due to reflections on the walls are inaudible).

The frequency of human voice typically ranges from 1 to 4 kHz.

The use of materials capable to reduce these frequencies allows better understanding of speech and prevents the need to talk loudly to cover the background noise.

The sound-absorbing appliance should be located 400-600 mm off the ceiling to ensure optimal operation.

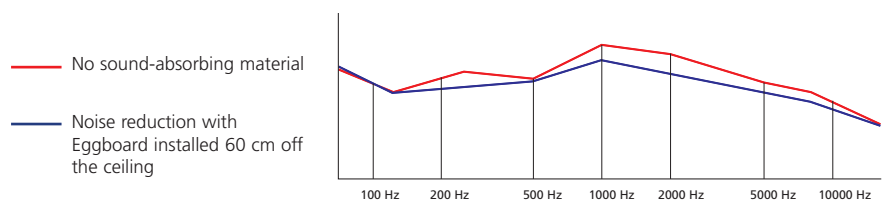

Eggboard Matrix 1 desk

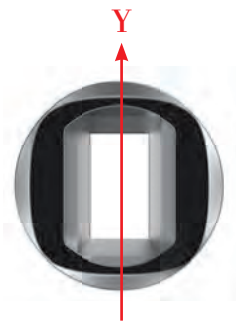
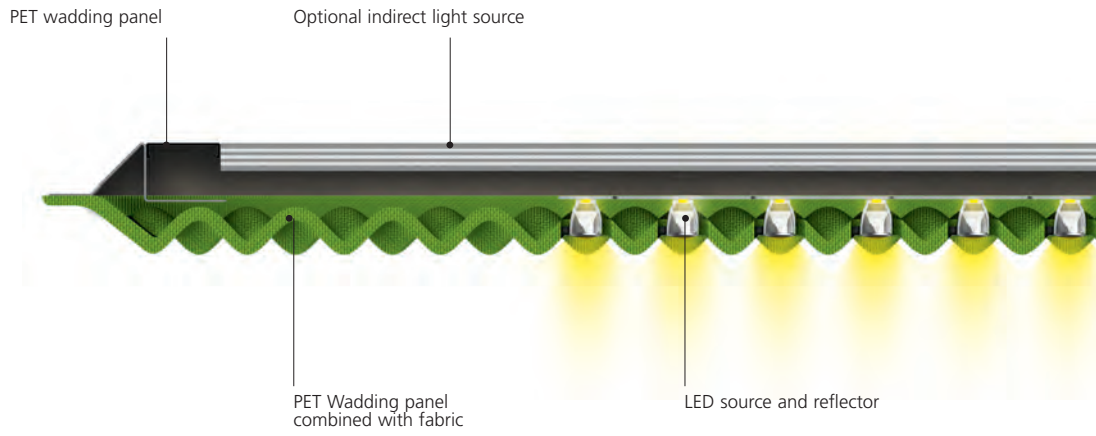
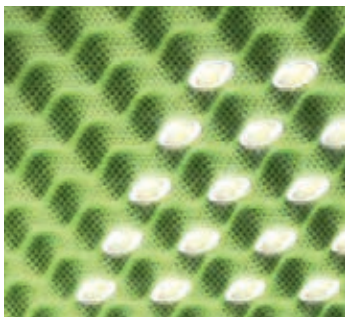

Rotating the elliptic-beam reflector along the Y axis allows to use the product to illuminate one workstation.

UGR < 12

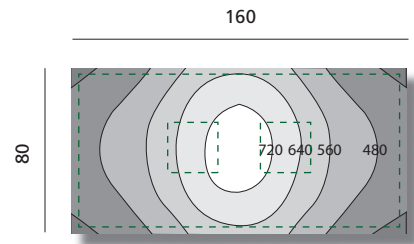

Eggboard Matrix 2 desk

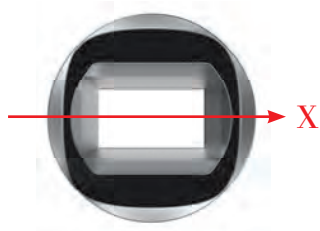
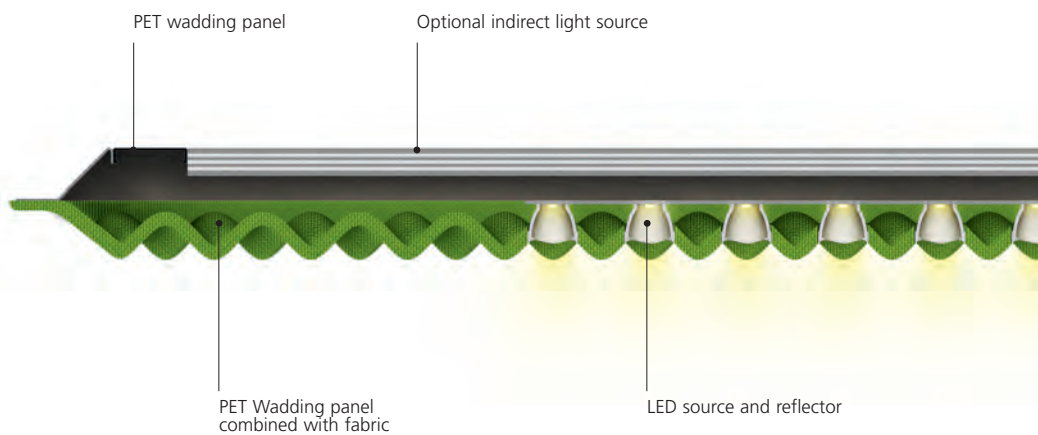
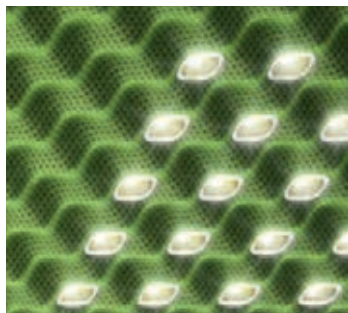

Rotating the elliptic-beam reflector along the X axis allows to use the product to illuminate two workstations.

UGR < 17

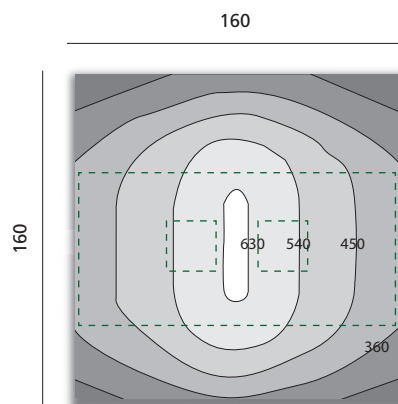

Eggboard Downlight

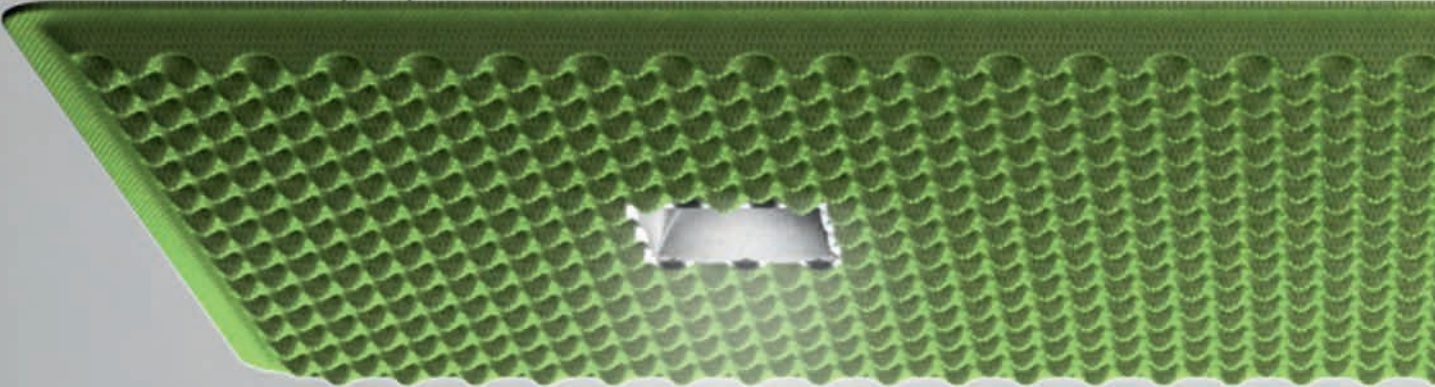

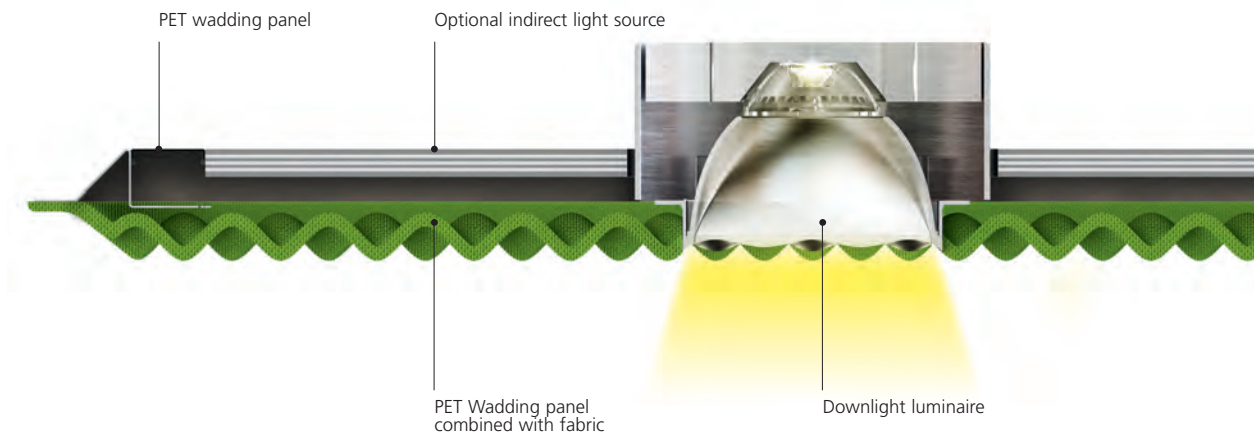

540

Controlled-beam reflector for downlight illumination.

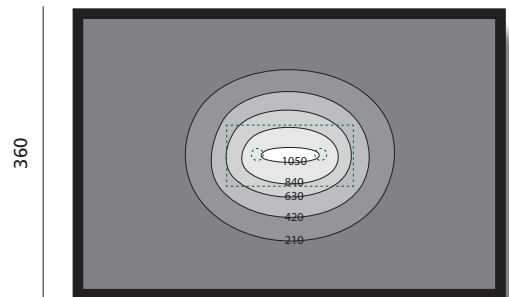

Eggboard

White ○ Grey ● Green ●

Eggboard Matrix Direct 1600X800

Dimmable

IP20

W	Weight	Beam	Flux	CCT	Color	Code
19 W	14 kg	56°	1824 lm	3000 K	○	M3100W21
					●	M3100W91
					●	M3100W51
		56°	1879 lm	4000 K	○	M3100N21
					●	M3100N91
					●	M3100N51

220/240Vac 50/60Hz electronic ballast included.

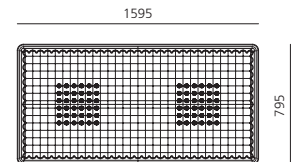
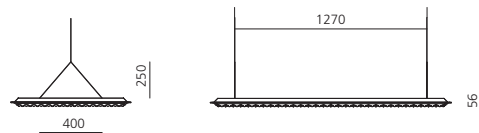

Eggboard Matrix Direct + Indirect 1600X800

Dimmable

IP20

W	Weight	Beam	Flux	CCT	Color	Code
76 W	15 kg	92°	7043 lm	3000 K	○	M3101W21
					●	M3101W91
					●	M3101W51
		92°	7255 lm	4000 K	○	M3101N21
					●	M3101N91
					●	M3101N51

220/240Vac 50/60Hz electronic ballast included.

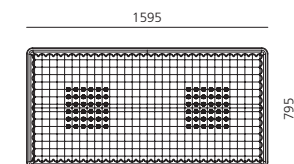
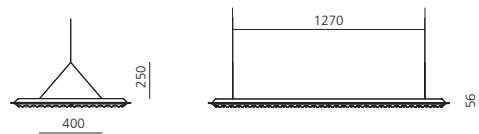

Eggboard Direct 1600X800

LED luminaire

19 W 3000 K α=56° 4000 K α=56°

	16 W	16 W	19 W	19 W
Power	16 W	16 W	19 W	19 W
Flux	2108 lm	2276 lm	1824 lm	1878 lm
CCT	3000 K	4000 K	3000 K	4000 K
CRI	=80 (min.)			
Color tolerance	MacAdam 4SDCM			
Service life	L70(6K)>50000h			
Beam			56°	56°
Efficiency			83%	83%
Efficacy	131 lm/W	141 lm/W	96 lm/W	97 lm/W

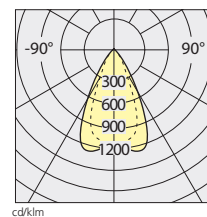

H m	Ø m	EMax lux	EM lux	H m	Ø m	EMax lux	EM lux
1	1,08	2133	1464	1	1,08	2197	1507
2	2,16	533	366	2	2,16	549	377
3	3,24	237	163	3	3,24	244	167
4	4,32	133	91	4	4,32	137	94
5	5,40	85	59	5	5,40	88	60

Eggboard Direct and Indirect 1600X800

LED luminaire

76 W 3000 K α=98° 4000 K α=98°

	65 W	65 W	76 W	76 W
Power	65 W	65 W	76 W	76 W
Flux	8498 lm	8876 lm	7043 lm	7255 lm
CCT	3000 K	4000 K	3000 K	4000 K
CRI	=80 (min.)			
Color tolerance	MacAdam 4SDCM			
Service life	L70(6K)>50000h			
Beam			98°	98°
Efficiency			83%	83%
Efficacy	131 lm/W	131 lm/W	93 lm/W	98 lm/W

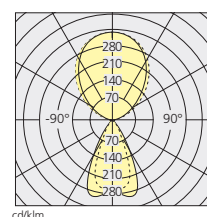

H m	Ø m	EMax lux	EM lux	H m	Ø m	EMax lux	EM lux
1	11,36	92	32	5	9,82	49	17
2	9,09	144	50	4	7,86	77	27
3	6,82	256	90	3	5,89	137	48
4	4,55	576	202	2	3,93	307	108
5	2,27	2304	807	1	1,96	1229	430

Eggboard Downlight Direct 1600X800

Dimmable

IP20

W	Weight	Beam	Flux	CCT	Color	Code
58 W	17 kg	32°	3440 lm	3000 K	<input type="radio"/>	M3104W21
					<input type="radio"/>	M3104W91
					<input checked="" type="radio"/>	M3104W51
		32°	3580 lm	4000 K	<input type="radio"/>	M3104N21
					<input type="radio"/>	M3104N91
					<input checked="" type="radio"/>	M3104N51

220/240Vac 50/60Hz electronic ballast included.

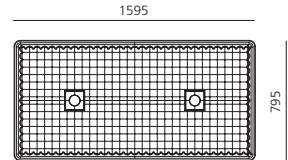
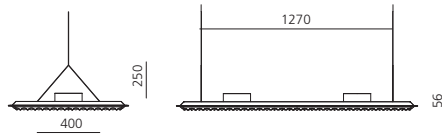

Eggboard Downlight Direct + Indirect 1600X800

Dimmable

IP20

W	Weight	Beam	Flux	CCT	Color	Code
170 W	18 kg	32°	9383 lm	3000 K	<input type="radio"/>	M3105W21
					<input type="radio"/>	M3105W91
					<input checked="" type="radio"/>	M3105W51
		32°	9665 lm	4000 K	<input type="radio"/>	M3105N21
					<input type="radio"/>	M3105N91
					<input checked="" type="radio"/>	M3105N51

220/240Vac 50/60Hz electronic ballast included.

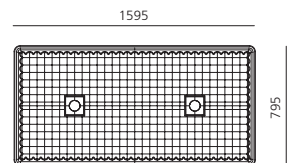
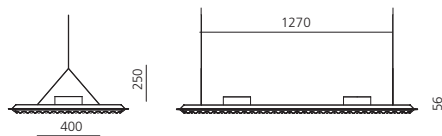

Eggboard 1600X800 (without light)

W	Weight	Beam	Flux	CCT	Color	Code
	10 kg				<input type="radio"/>	M310820
					<input type="radio"/>	M310890
					<input checked="" type="radio"/>	M310850

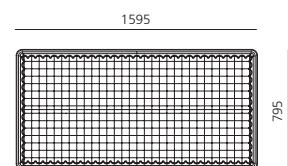
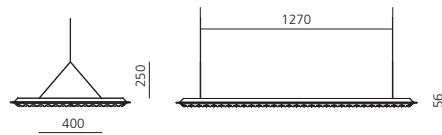

Eggboard Downlight Direct 1600X800

LED luminaire 58 W 3000 K α=32° 4000 K α=32°

	49 W	49 W	58 W	58 W
Power	49 W	49 W	58 W	58 W
Flux	5020 lm	5240 lm	3440 lm	3580 lm
CCT	3000 K	4000 K	3000 K	4000 K
CRI	=80 (min.)			
Color tolerance	MacAdam 3SDCM			
Service life	L70(9K)>50000h			
Beam			32°	32°
Efficiency			68%	68%
Efficacy	103 lm/W	107 lm/W	60 lm/W	63 lm/W

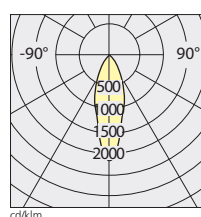

H	Ø	EMax	EM	H	Ø	EMax	EM
m	m	lux	lux	m	m	lux	lux
1	0,57	7166	4044	1	0,57	7457	4209
2	1,14	1791	1011	2	1,14	1864	1052
3	1,71	796	449	3	1,71	829	468
4	2,28	448	253	4	2,28	466	263
5	2,85	287	162	5	2,85	298	168

Eggboard

White ○ Grey ● Green ●

Eggboard Matrix Direct 800X800

Dimmable

IP20

W	Weight	Beam	Flux	CCT	Color	Code
9,5 W	7 kg	56°	875 lm	3000 K	○	M3102W21
					●	M3102W91
					●	M3102W51
		56°	983 lm	4000 K	○	M3102N21
					●	M3102N91
					●	M3102N51



795

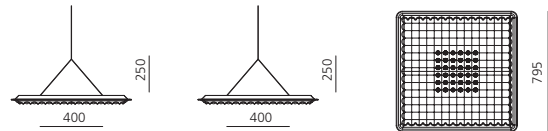

220/240Vac 50/60Hz electronic ballast included.

Eggboard Matrix Direct + Indirect 800X800

Dimmable

IP20

W	Weight	Beam	Flux	CCT	Color	Code
38 W	7,5 kg	90°	3517 lm	3000 K	○	M3103W21
					●	M3103W91
					●	M3103W51
		90°	3755 lm	4000 K	○	M3103N21
					●	M3103N91
					●	M3103N51



795

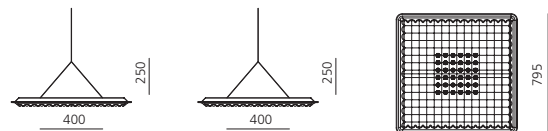

220/240Vac 50/60Hz electronic ballast included.

Eggboard Direct 800X800

LED

luminaire

9,5 W

3000 K

$\alpha=56^\circ$

4000 K

$\alpha=56^\circ$

Power	8 W	8 W	9,5 W	9,5 W
Flux	1054 lm	1138 lm	875 lm	983 lm
CCT	3000 K	4000 K	3000 K	4000 K
CRI	=80 (min.)			
Color tolerance	MacAdam 4SDCM			
Service life	L70(6K)>50000h			
Beam			56°	56°
Efficiency			83%	83%
Efficacy	131 lm/W	141 lm/W	96 lm/W	97 lm/W

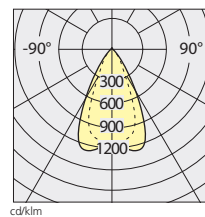

cd/klm

H m	Ø m	EMax lux	EM lux	H m	Ø m	EMax lux	EM lux
1	1,08	2133	1464	1	1,08	2197	1507
2	2,16	533	366	2	2,16	549	377
3	3,24	237	163	3	3,24	244	167
4	4,32	133	91	4	4,32	137	94
5	5,40	85	59	5	5,40	88	60

Eggboard Direct and Indirect 800X800

LED

luminaire

38 W

3000 K

$\alpha=90^\circ$

4000 K

$\alpha=90^\circ$

Power	32 W	36 W	38 W	42 W
Flux	4238 lm	4470 lm	3517 lm	3755 lm
CCT	3000 K	4000 K	3000 K	4000 K
CRI	=80 (min.)			
Color tolerance	MacAdam 4SDCM			
Service life	L70(6K)>50000h			
Beam			90°	90°
Efficiency			83%	83%
Efficacy	131 lm/W	131 lm/W	93 lm/W	98 lm/W

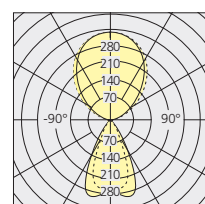

cd/klm

H m	Ø m	EMax lux	EM lux	H m	Ø m	EMax lux	EM lux
5	9,82	46	16	5	9,82	49	17
4	7,86	72	25	4	7,86	77	27
3	5,89	128	45	3	5,89	137	48
2	3,93	288	101	2	3,93	307	108
1	1,96	1151	403	1	1,96	1229	430

Eggboard Downlight Direct 800X800

Dimmable

IP20

W	Weight	Beam	Flux	CCT	Color	Code
29 W	8,5 kg	32°	1720 lm	3000 K	<input type="radio"/>	M3106W21
					<input type="radio"/>	M3106W91
					<input checked="" type="radio"/>	M3106W51
		32°	1790 lm	4000 K	<input type="radio"/>	M3106N21
					<input type="radio"/>	M3106N91
					<input checked="" type="radio"/>	M3106N51

220/240Vac 50/60Hz electronic ballast included.

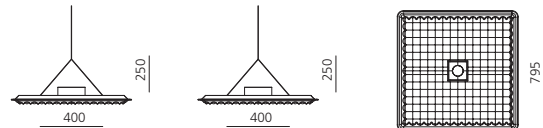

Eggboard Downlight Direct + Indirect 800X800

Dimmable

IP20

W	Weight	Beam	Flux	CCT	Color	Code
48 W	9 kg	32°	3805 lm	3000 K	<input type="radio"/>	M3107W21
					<input type="radio"/>	M3107W91
					<input checked="" type="radio"/>	M3107W51
		32°	3895 lm	4000 K	<input type="radio"/>	M3107N21
					<input type="radio"/>	M3107N91
					<input checked="" type="radio"/>	M3107N51

220/240Vac 50/60Hz electronic ballast included.

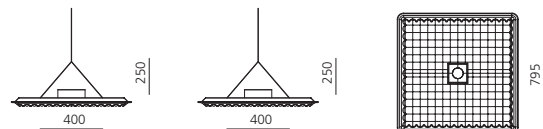
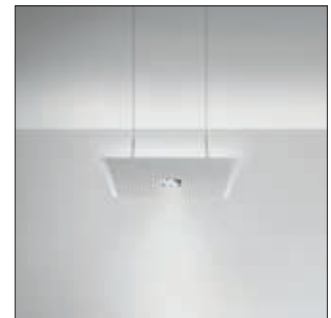

Eggboard 800X800 (without light)

W	Weight	Beam	Flux	CCT	Color	Code
	5 kg				<input type="radio"/>	M310920
					<input type="radio"/>	M310990
					<input checked="" type="radio"/>	M310950

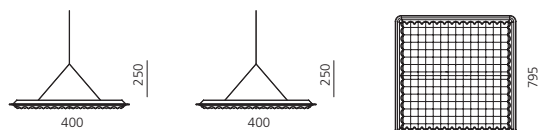

Eggboard Downlight Direct 800X800

LED	luminaire	
Power	24,5 W	29 W
Flux	2510 lm	1720 lm
CCT	3000 K	4000 K
CRI	=80 (min.)	
Color tolerance	MacAdam 3SDCM	
Service life	L70(9K)>50000h	
Beam	32°	32°
Efficiency	68%	68%
Efficacy	103 lm/W	63 lm/W

29 W 3000 K α=32° 4000 K α=32°

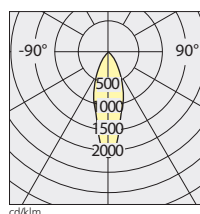

H	Ø	EMax	EM	H	Ø	EMax	EM
m	m	lux	lux	m	m	lux	lux
1	0,57	3583	2022	1	0,57	3729	2104
2	1,14	896	506	2	1,14	932	526
3	1,71	398	225	3	1,71	414	234
4	2,28	224	126	4	2,28	233	132
5	2,85	143	81	5	2,85	149	84

Pad System





Carlotta de Bevilacqua
2014

- Modular system with direct emission and indirect with LED high efficiency.
- UGR <19
- Ultra thin profile
- Edge Backlighting Technology
- Available in two colors: warm white (3000K), neutral white (4000K) - CRI = 85 (typ.)
- Installation with suspension.
- Single mounting, in continuous line by angle (90°), free composition.
- Non dimmable, dimmable electronic power supply Dali.
- Materials: structure in extruded aluminum.
- Suspension cables in steel with quick adjustment.
- Complies with EN62471, EN60598-1 and other specific standards.

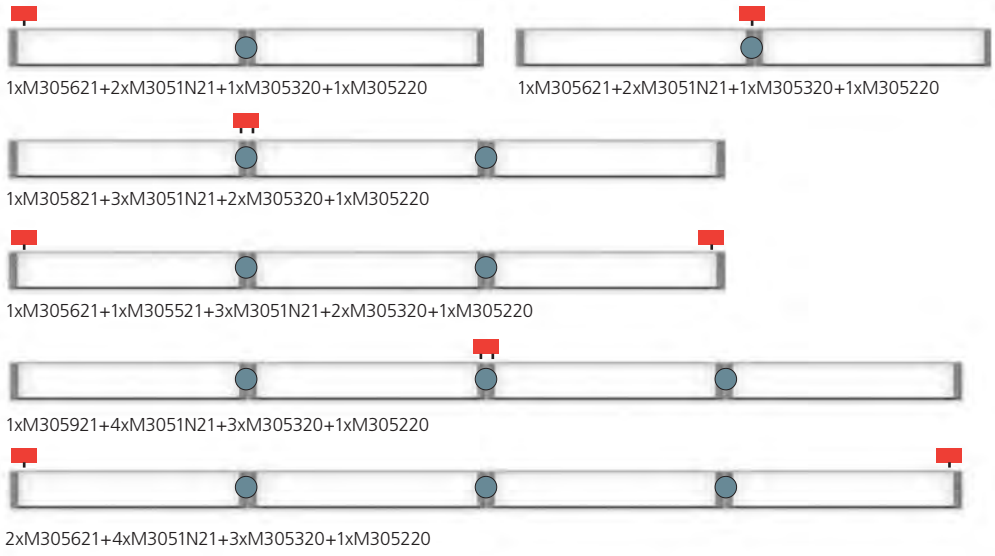

Pad System Configuration



-  Kit driver linear connector (1M; 2M)
-  Kit driver linear and angular connector (1M+1M; 1M+2M; 2M+2M)
-  Linear connector
-  Angular connector

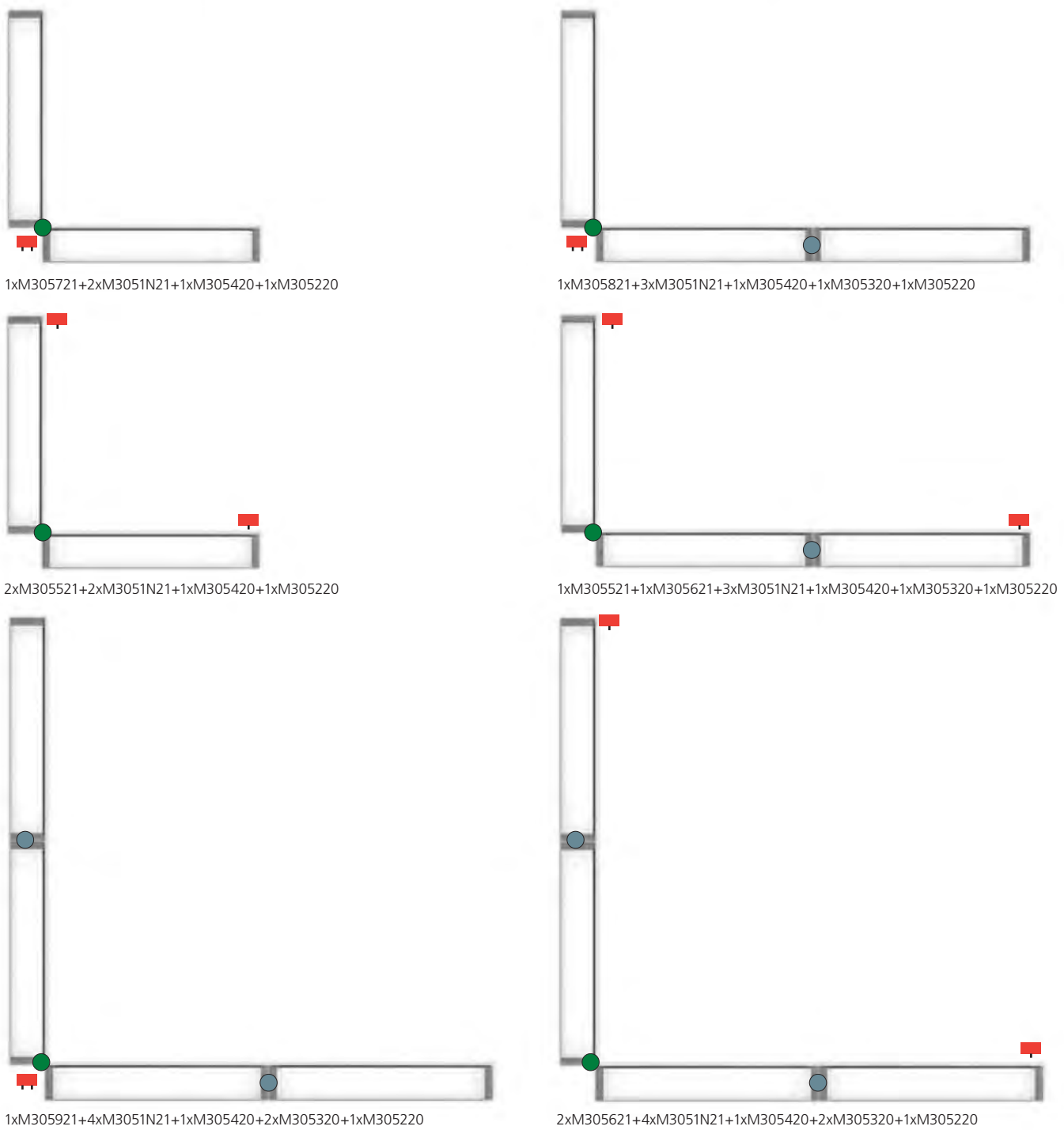







Pad System

White
○

Gloss anodised
●

W	Flux	CCT	Color	Code
36 W	2688 lm	3000 K	●	M3051W61
			○	M3051W21
	3125 lm	4000 K	●	M3051N61
			○	M3051N21



UGR<19

36 W

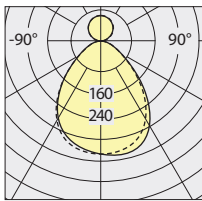

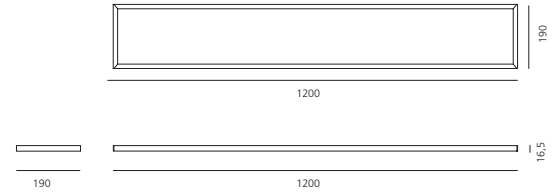

cd/klm
 - - - C0 - C180
 - - - C90 - C270

IP20



Accessories

	Color	Code
 End cap	● ○	M305260 M305220
 L-shaped connector	● ○	M305360 M305320
 90° shaped connector	● ○	M305460 M305420

Accessories

	Code
Kit driver linear connector 1M Occupies 1 Dali destination.	M305521
Kit driver linear connector 2M Occupies 1 Dali destination.	M305621
Kit driver linear and angular connector 1M+1M Occupies 1 Dali destination.	M305721
Kit driver linear and angular connector 1M+2M Occupies 2 Dali destination.	M305821
Kit driver linear and angular connector 2M+2M Occupies 2 Dali destination.	M305921

Pad System Stand-alone

White
○

Gloss anodised
●

				Dali-SwitchDim
W	Flux	CCT	Color	Code
48 W	3873 lm	3000 K	●	M3050W61
			○	M3050W21
	3873 lm	4000 K	●	M3050N61
			○	M3050N21

UGR<19
220/240Vac 50/60Hz electronic ballast included.

48 W

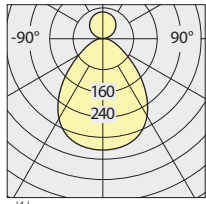

--- C0 - C180
..... C90 - C270



IP20 ☹

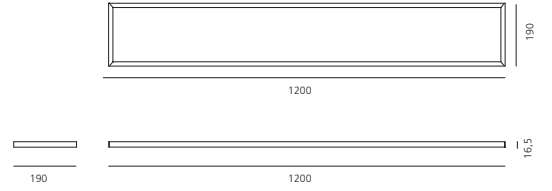

scale 1:1

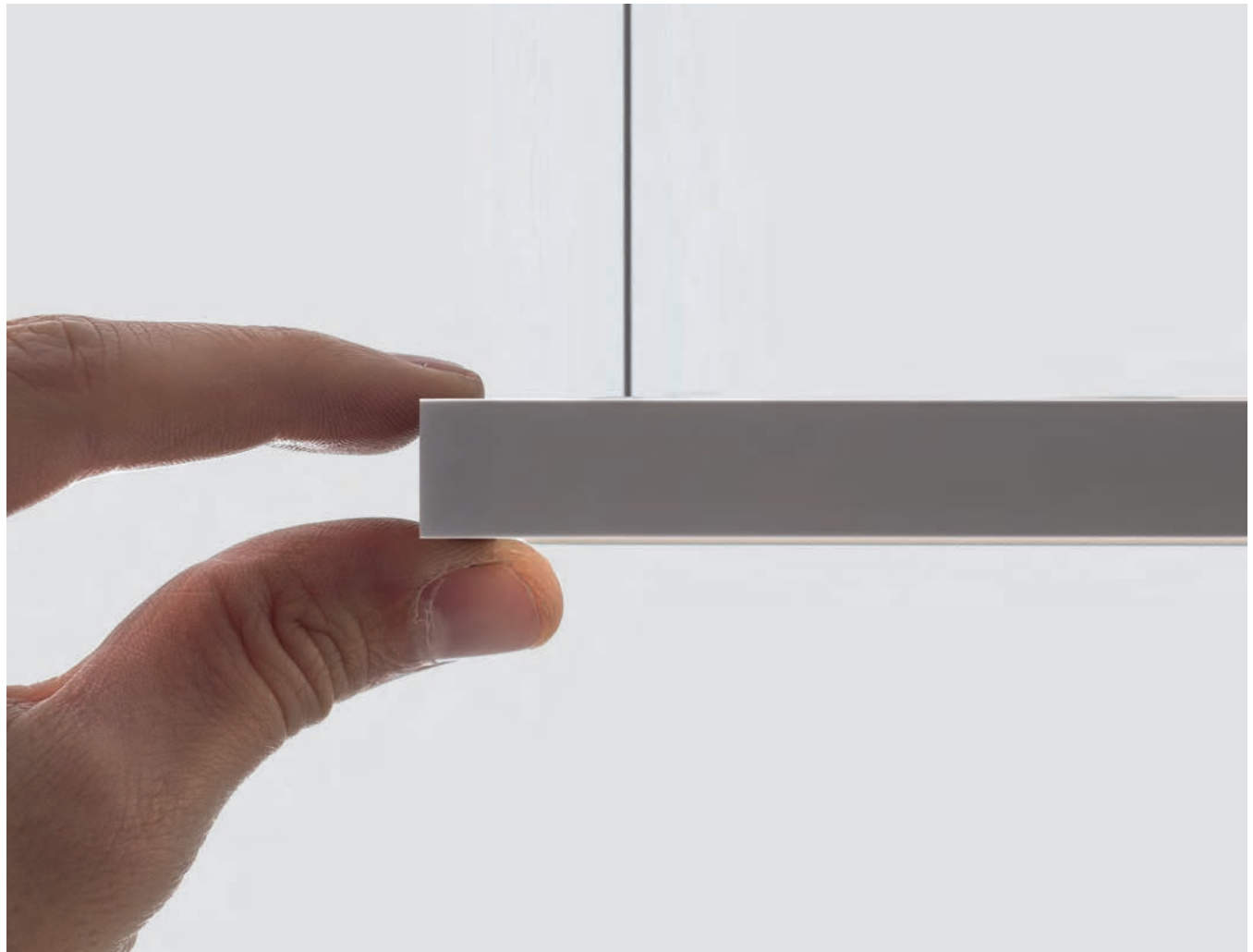



- Modular system with direct emission and indirect with LED high efficiency.
- Available in two colours: warm white (3000K), neutral white (4000K) - CRI = 85 (typ.)
- Installation with suspension.
- Single mounting, in continuous line by angle (90°), free composition
- Dimmable electronic power supply Dali.
- Materials: structure in extruded aluminum anodised matte, top screen with anti-dust polycarbonate, staples in 6 different tones.
- Quick adjustment steel suspension cables.
- Complies with EN62471, EN60598-1 and other specific standards.



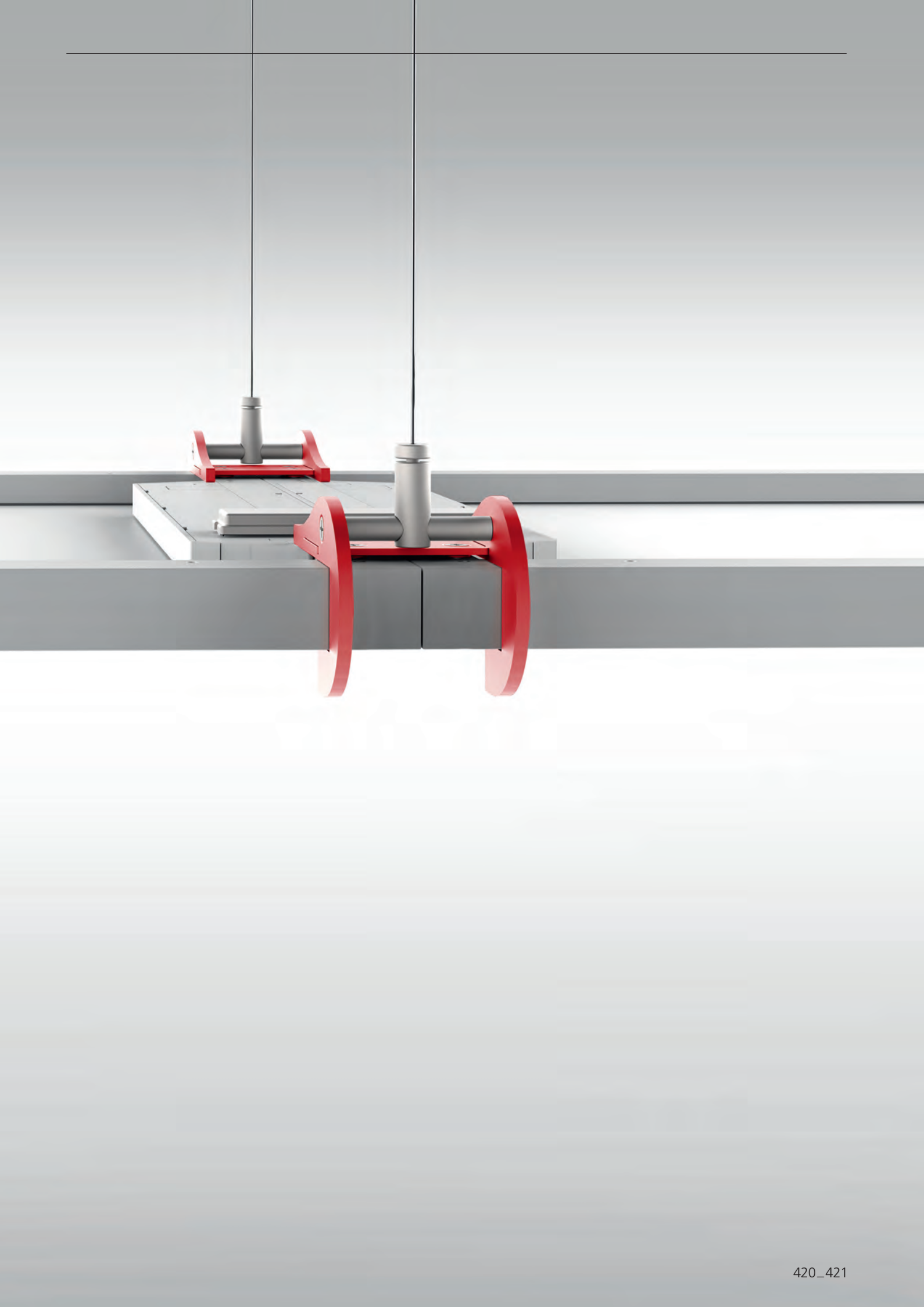

Grafa System

System Modules

Module
1200x300
single



Module
1200x300
modular



Module
600x600
single



Module
600x600
modular linear



Module
600x600
modular angular

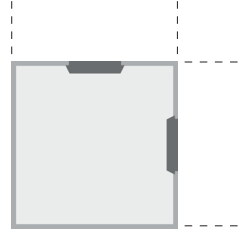

Suspended Accessories

Single Clip



Angular Brackets

Double Clip



Mixed Modules Brackets

Angular Clip



Suspended Brackets

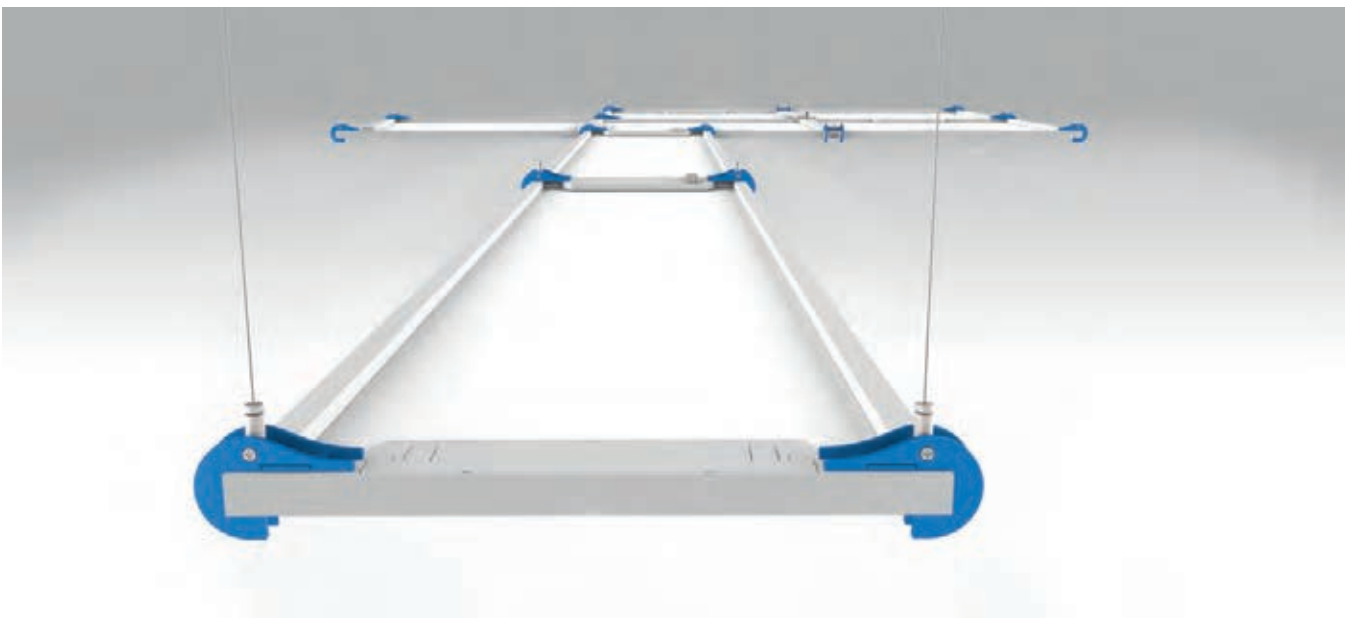

Grafa System

Driver Links

Kit driver 1X - end links
2 possible positions A-B

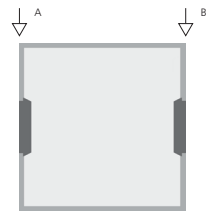

Kit driver 2X - central links
3 possible positions A-B-C

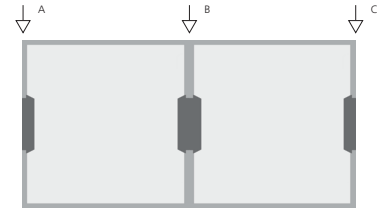

Kit 3X central links
2 possible positions A-B

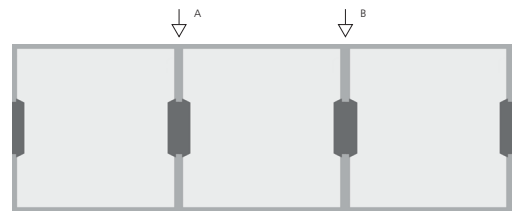

Kit 4X central links
one possible position A

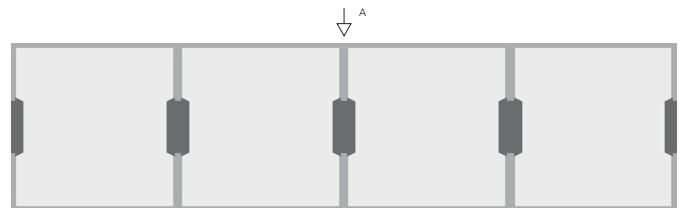

Driver Positions

Kit driver 1X - end links
2 possible positions A-B



Kit driver 2X - central links
3 possible positions A-B-C

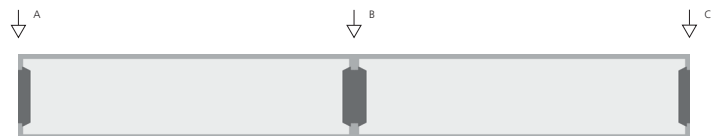

Kit 3X central links
2 possible positions A-B



Kit 4X central links
one possible position A

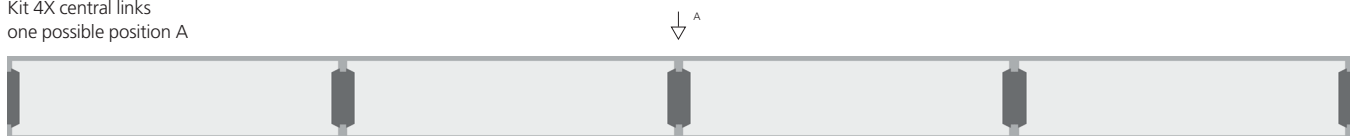





Example of a complex configuration:

Modules

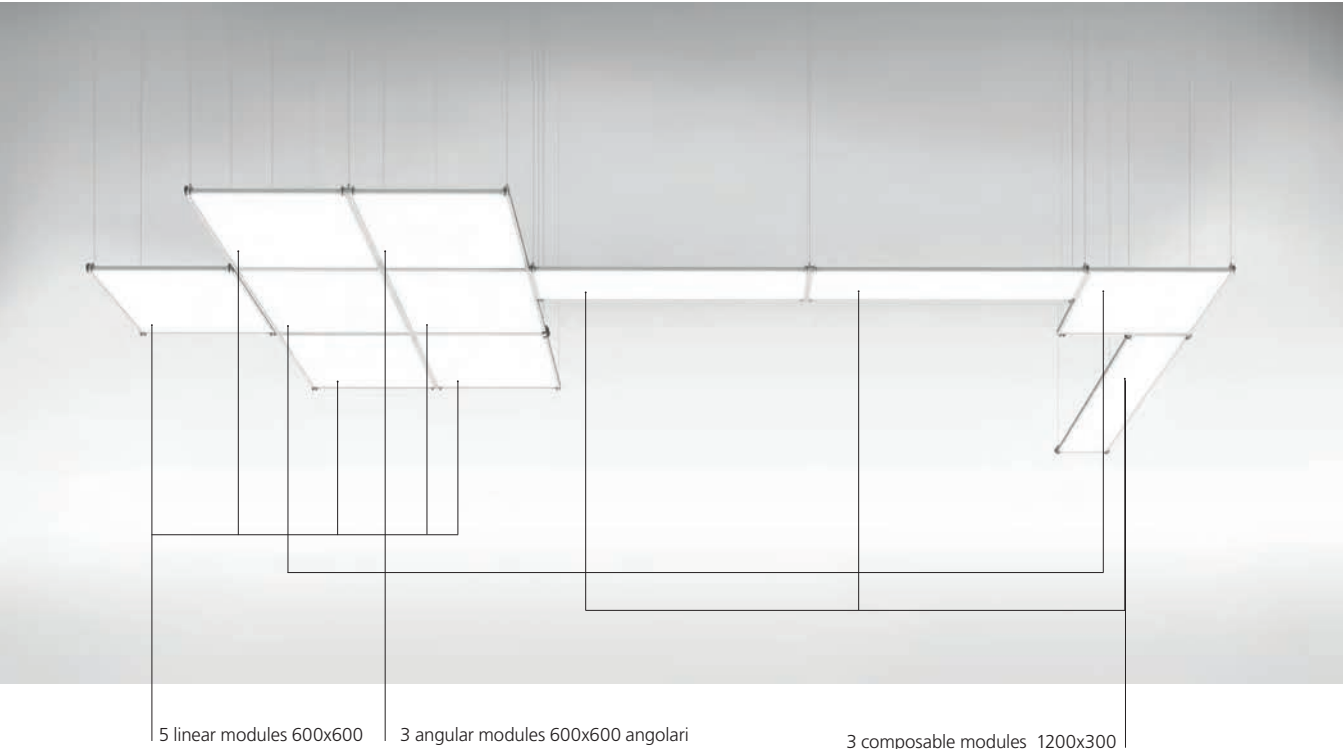

Power supplies

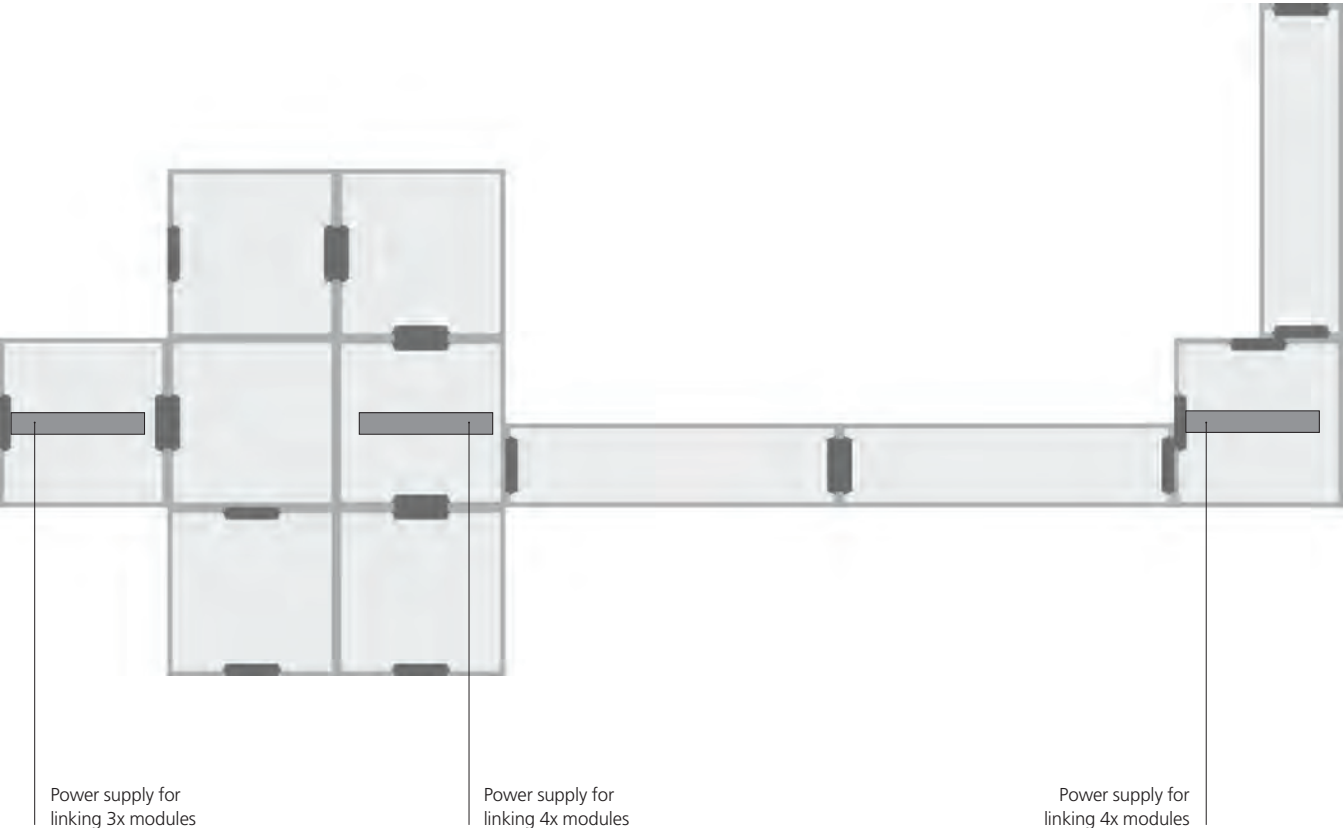

Grafa System

Example of a complex configuration:

Clips

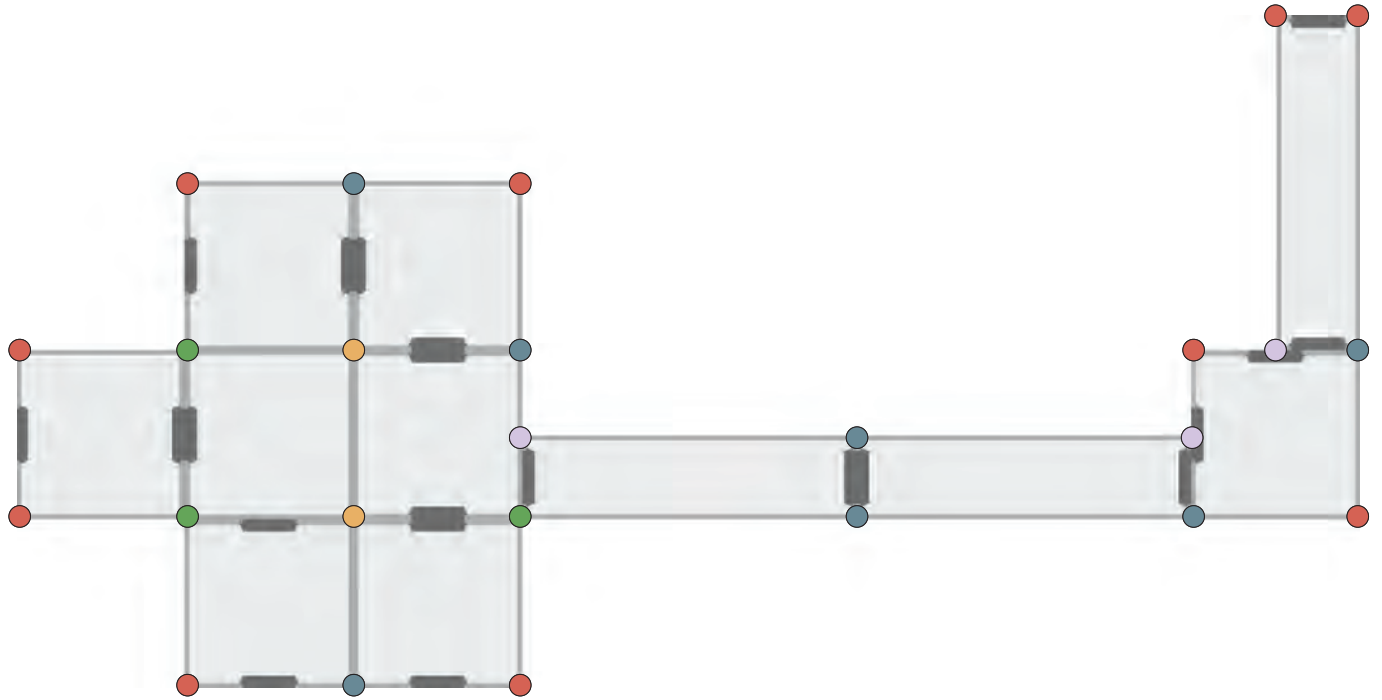

- clip 1 module
- clip 2 module
- clip 3 module
- clip 4 module
- clip linking modules 1200/600

Suspension

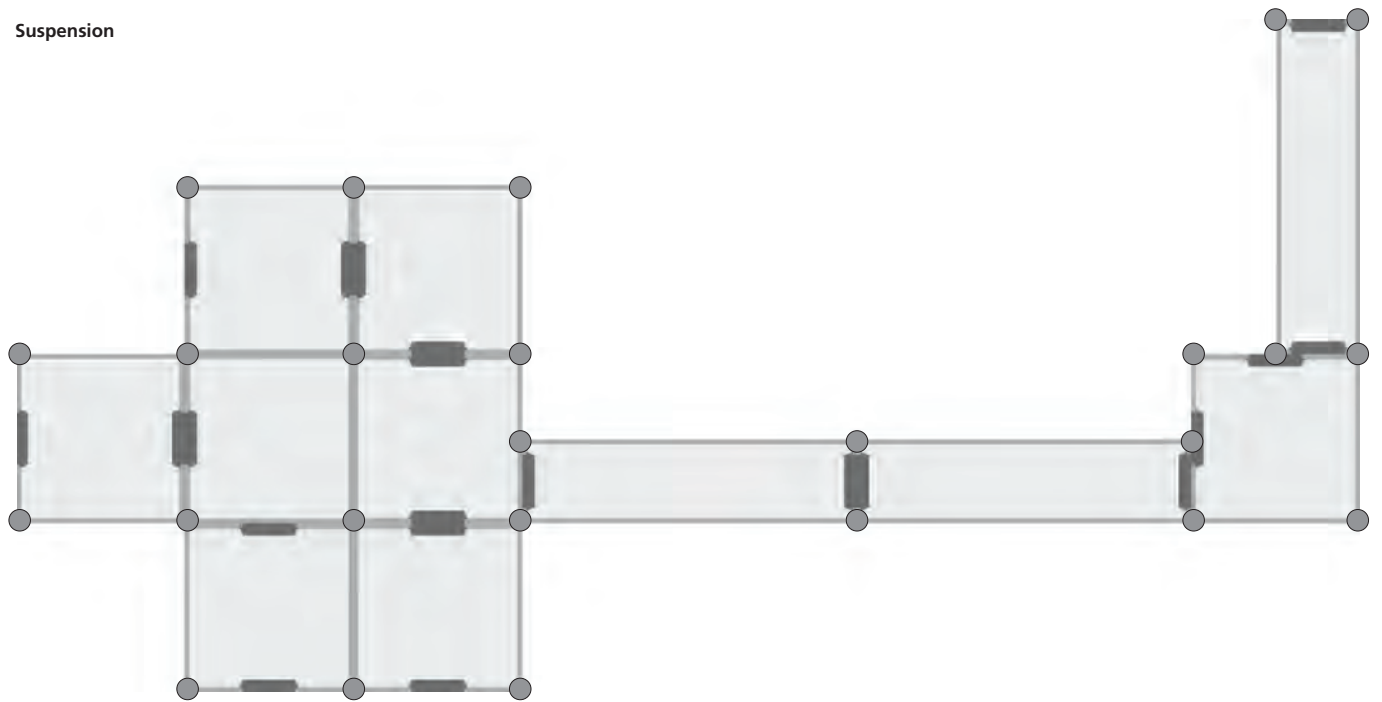

- Points of cable positioning

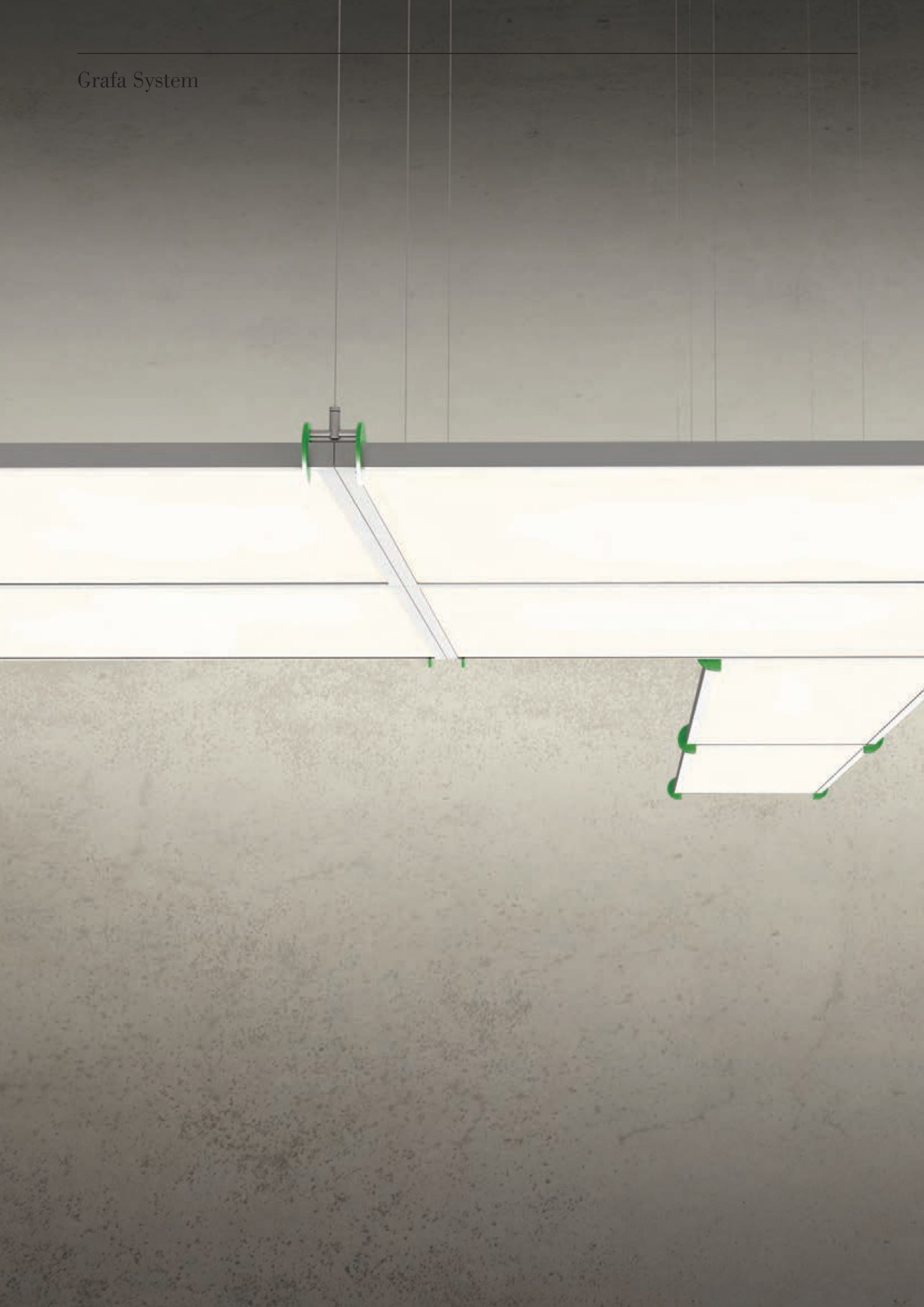

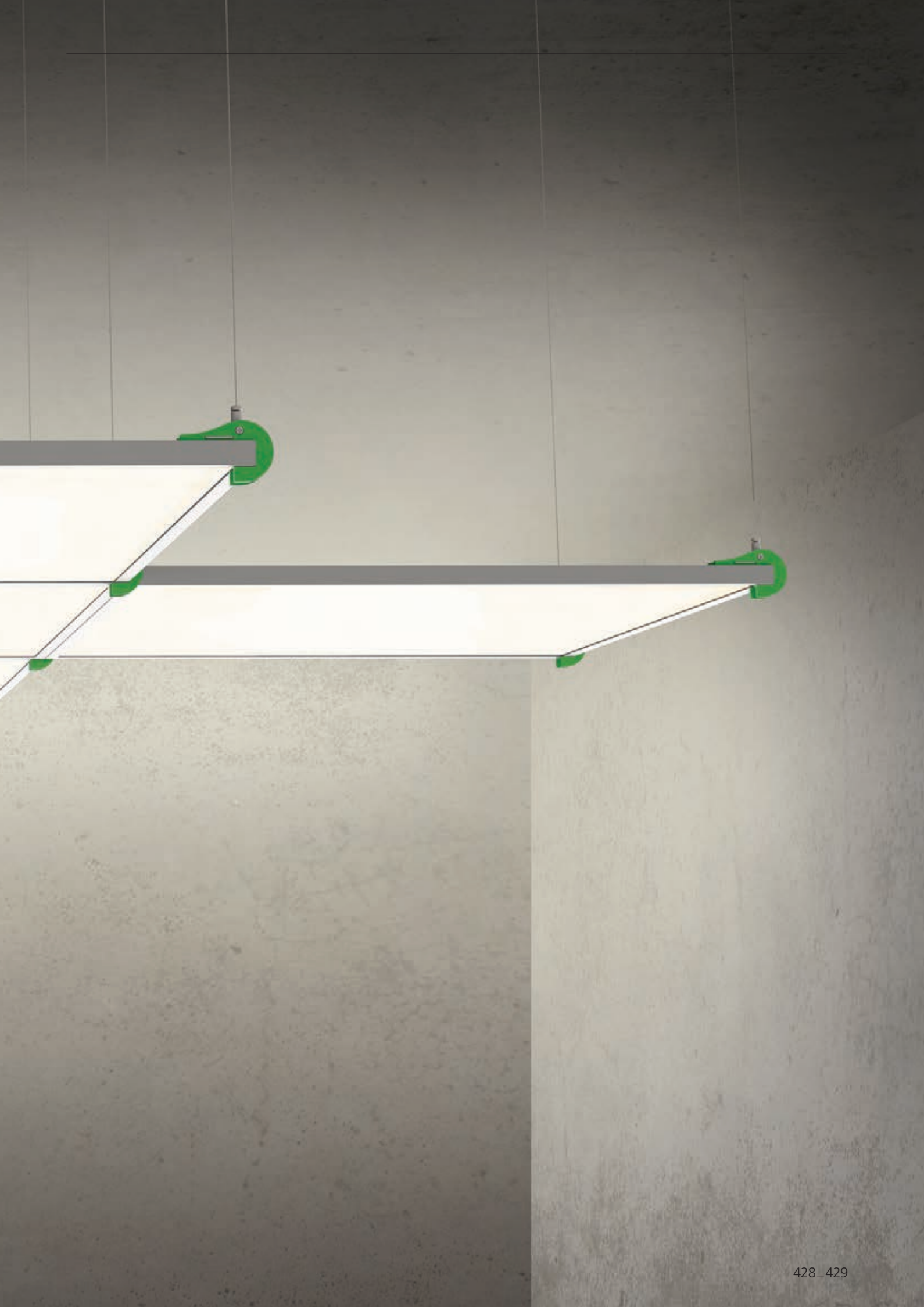

Grafa System

Structural Module 600x600

Cables	W	Weight	Flux	CCT	Code
linear	36 W	4,00 kg	3334 lm	3000 K	M3003W61
			3577 lm	4000 K	M3003N61
angular			3334 lm	3000 K	M3004W61
			3577 lm	4000 K	M3004N61

Driver SELV supplied separately.

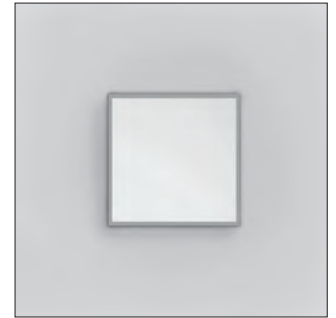

IP20 ☹

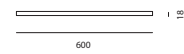
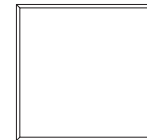

Structural Module 1200x300

Cables	W	Weight	Flux	CCT	Code
linear	36 W	4,00 kg	3334 lm	3000 K	M3001W61
			3577 lm	4000 K	M3001N61

Driver SELV supplied separately.







IP20 ☹



Grafa System

	LED		luminaire		36 W	3000 K		4000 K					
Power	30 W	30 W	36 W	36 W		H	Ø	EMax	EM	H	Ø	EMax	EM
Flux	3789 lm	4055 lm	3334 lm	3577 lm		m	m	lux	lux	m	m	lux	lux
CCT	3000 K	4000 K	3000 K	4000 K		1	1,88	1040	415	1	1,93	1116	445
CRI	=80 (min)					2	3,75	260	104	2	3,85	279	111
Color tolerance	MacAdam 4SDCM					3	5,63	116	46	3	5,78	124	49
UGR	19	19			4	7,50	65	26	4	7,71	70	28	
Efficiency	88%	88%	88%	88%	5	9,38	42	17	5	9,64	45	18	
Efficacy	126 lm/W	135 lm/W	93 lm/W	99 lm/W	cd/klm								

Clips		Color	Code
	Clips singular module	○	M301020
		●	M301030
		●	M301050
		●	M301000
		●	M301010
		●	M301040
	Linking Clips 2 modules	○	M301120
		●	M301130
		●	M301150
		●	M301100
		●	M301110
		●	M301140
	Linking Clips 3 modules	○	M301220
		●	M301230
		●	M301250
		●	M301200
		●	M301210
		●	M301240
	Linking Clips 4 modules	○	M301320
		●	M301330
		●	M301350
		●	M301300
		●	M301310
		●	M301340
	Linking Clips modules 1200x300 with 600x600	○	M301420
		●	M301430
		●	M301450
		●	M301400
		●	M301410
		●	M301440

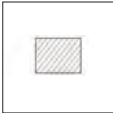
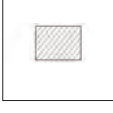
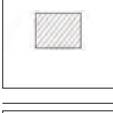
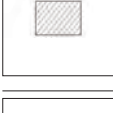
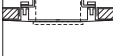
Driver		Dimmable Dali
	Ceiling plate form x 1 + 1 power supply cord Occupies 1 Dali destination.	End M300591
	Ceiling plate x 2 modules 1 power supply cord 1 cable connection 1 cover for electrical connection Occupies 1 Dali destination.	End and Central M300691
	Ceiling plate x 3 modules 2 power supply cord 1 cable connection 1 cover for electrical connection Occupies 1 Dali destination.	Central M300791
	Ceiling plate x 4 modules 2 power supply cord 2 cable connection 2 cover for electrical connection Occupies 1 Dali destination.	Central M300891
	Recessed kit (except x driver module 600x600 SA)	M301500

Grafa Stand Alone





Grafa Stand Alone

Structural module 600x600 Stand-Alone

W	Weight	Flux	CCT
36 W	4,00 kg	3334 lm 3577 lm	3000 K 4000 K

Dali-SwitchDim

Code
M3002W61 M3002N61

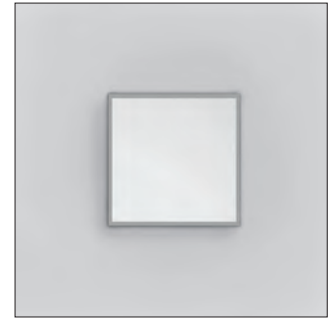

IP20 ☹

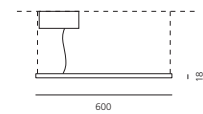
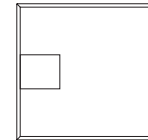

220/240Vac 50/60Hz electronic ballast included.
Occupies 1 Dali destination.

Structural module 1200x300 Stand-Alone

W	Weight	Flux	CCT
36 W	4,00 kg	3573 lm 3823 lm	3000 K 4000 K

Dali-SwitchDim

Code
M3000W61 M3000N61

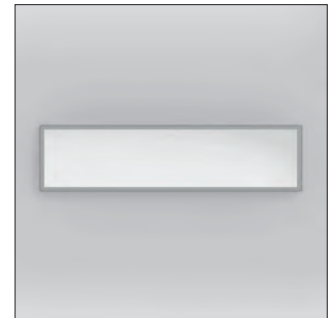

IP20 ☹

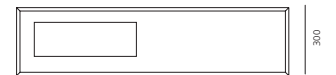

220/240Vac 50/60Hz electronic ballast included.
Occupies 1 Dali destination.

Grafa Stand Alone

Power	30 W	30 W	36 W	36 W
Flux	3789 lm	4055 lm	3334 lm	3577 lm
CCT	3000 K	4000 K	3000 K	4000 K
CRI	=80 (min)			
Color tolerance	MacAdam 4SDCM			
UGR	19	19		
Efficiency	88%	88%	88%	88%
Efficacy	126 lm/W	135 lm/W	93 lm/W	99 lm/W

LED

luminaire

36 W

3000 K

4000 K

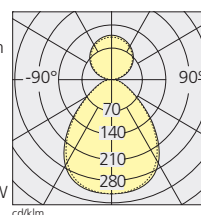

H	Ø	EMax	EM	H	Ø	EMax	EM
m	m	lux	lux	m	m	lux	lux
1	1,88	1106	437	1	1,88	1183	467
2	3,77	276	109	2	3,77	296	117
3	5,65	123	49	3	5,65	131	52
4	7,54	69	27	4	7,54	74	29
5	9,42	44	17	5	9,42	47	19

Grafa Stand-Alone

Clips		Color	Code
	Clips singular module	○	M301020
		●	M301030
		●	M301050
		●	M301000
		●	M301010
		●	M301040

Linking Clips		Color	Code
	Linking Clips 4 modules	○	M301620
		●	M301630
		●	M301650
		●	M301600
		●	M301610
		●	M301640

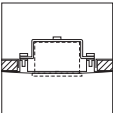
Driver	Links	Dimmable Dali Code
	Recessed kit x driver module 600x600 SA	M301500
	Recessed kit x driver module 1200x300 SA	M300900

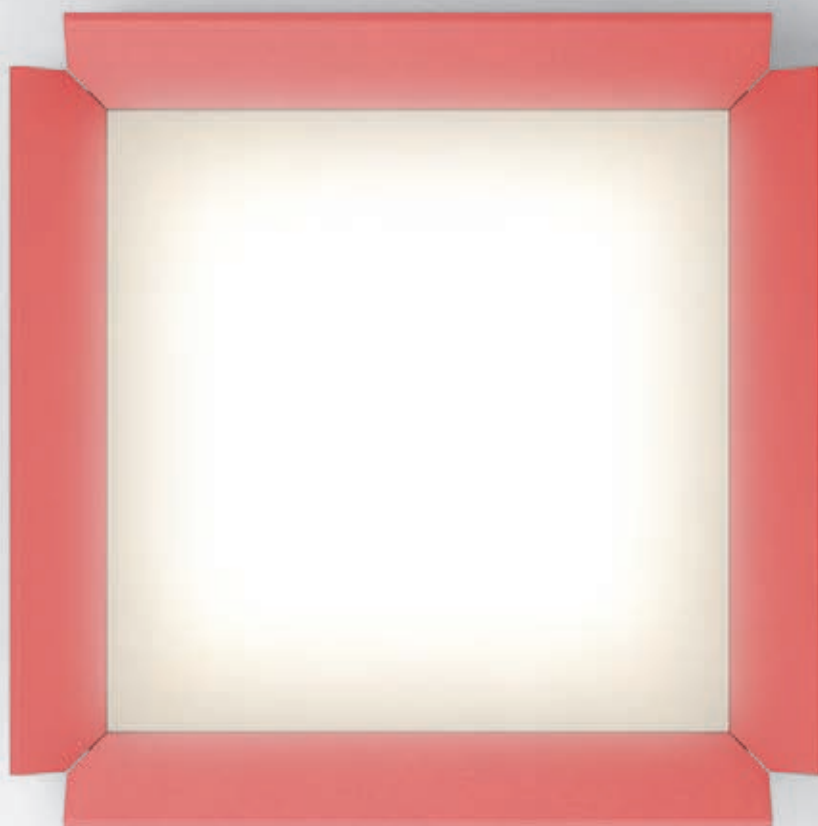



Gradian



- A system of direct-emission panels with two mounting options – ceiling or wall – in individual or multiple configurations.
- High-efficiency LED Edge Backlighting technology.
- The outer frame consists of a set of protruding wings that collect the emitted light, thus ensuring maximum visual comfort with limited contrast between the appliance and its background.
- Extruded aluminium frame available in 6 colours: white, grey, anthracite grey, red, blue and green.
- Complies with the EN12464 norm, UGR<19.

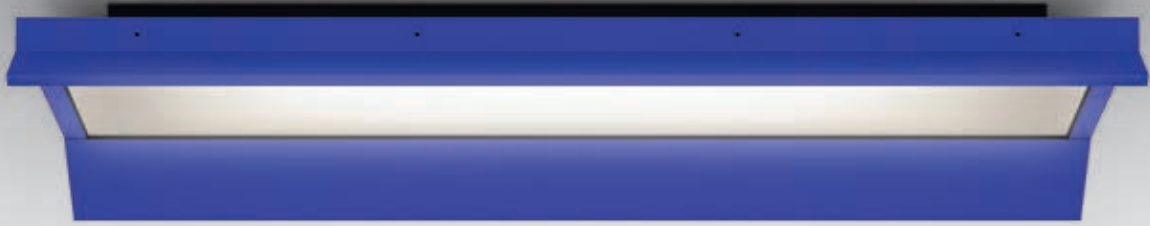

Gradian

White Grey Red Blue

Gradian 600X600

Dimmable 1:10V

W	Weight	Beam	Flux	CCT	Color	Code
35 W	14 kg	86°	3310 lm	3000 K	<input type="radio"/>	M3200W21
					<input type="radio"/>	M3200W61
					<input type="radio"/>	M3200W41
					<input type="radio"/>	M3200W31
		86°	3517 lm	4000 K	<input type="radio"/>	M3200N21
					<input type="radio"/>	M3200N61
					<input type="radio"/>	M3200N41
					<input type="radio"/>	M3200N31



IP20

220/240Vac 50/60Hz electronic ballast included.

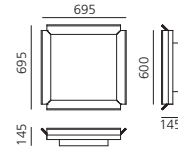

Gradian 1200X600

Dimmable 1:10V

W	Weight	Beam	Flux	CCT	Color	Code
35 W	28 kg	86°	6619 lm	3000 K	<input type="radio"/>	M3201W21
					<input type="radio"/>	M3201W61
					<input type="radio"/>	M3201W41
					<input type="radio"/>	M3201W31
		86°	7034 lm	4000 K	<input type="radio"/>	M3201N21
					<input type="radio"/>	M3201N61
					<input type="radio"/>	M3201N41
					<input type="radio"/>	M3201N31



IP20

220/240Vac 50/60Hz electronic ballast included.

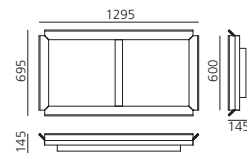

Gradian 1200X1200

Dimmable 1:10V

W	Weight	Beam	Flux	CCT	Color	Code
35 W	56 kg	86°	13238 lm	3000 K	<input type="radio"/>	M3202W21
					<input type="radio"/>	M3202W61
					<input type="radio"/>	M3202W41
					<input type="radio"/>	M3202W31
		86°	14068 lm	4000 K	<input type="radio"/>	M3202N21
					<input type="radio"/>	M3202N61
					<input type="radio"/>	M3202N41
					<input type="radio"/>	M3202N31



IP20

220/240Vac 50/60Hz electronic ballast included.

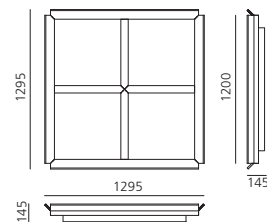

White ○ Grey ● Red ● Blue ●

Gradian 1200X300

Dimmable 1:10V

IP20

W	Weight	Beam	Flux	CCT	Color	Code
35 W	13,5 kg	86°	3310 lm	3000 K	○	M3203W21
					●	M3203W61
					●	M3203W41
					●	M3203W31
		86°	3517 lm	4000 K	○	M3203N21
					●	M3203N61
					●	M3203N41
					●	M3203N31

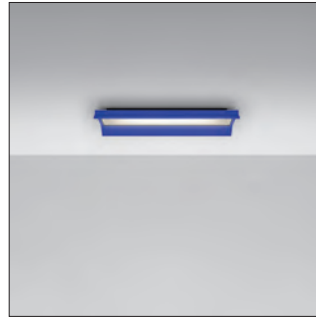

220/240Vac 50/60Hz electronic ballast included.

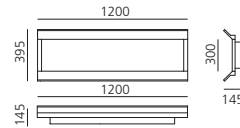

Gradian 2400X300

Dimmable 1:10V

IP20

W	Weight	Beam	Flux	CCT	Color	Code
70 W	27 kg	86°	6619 lm	3000 K	○	M3204W21
					●	M3204W61
					●	M3204W41
					●	M3204W31
		86°	7034 lm	4000 K	○	M3204N21
					●	M3204N61
					●	M3204N41
					●	M3204N31



220/240Vac 50/60Hz electronic ballast included.

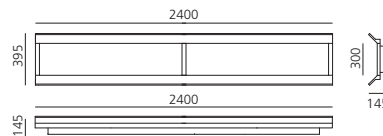

Gradian 600X600

LED luminaire

	32 W	32 W	35 W	35 W
Power	32 W	32 W	35 W	35 W
Flux	4136 lm	4396 lm	3310 lm	3517 lm
CCT	3000 K	4000 K	3000 K	4000 K
CRI	=80 (min.)			
Color tolerance	MacAdam 4SDCM			
Service life	L70(10K)>50000h			
Beam			86°	86°
Efficiency			80%	80%
Efficacy	129 lm/W	137 lm/W	94 lm/W	100 lm/W

35 W 3000 K α=86° 4000 K α=86°

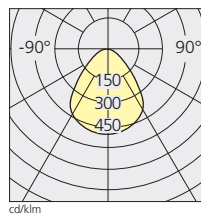

H m	Ø m	EMax lux	EM lux	H m	Ø m	EMax lux	EM lux
1	1,88	1595	658	1	1,88	1695	699
2	3,77	399	164	2	3,77	424	175
3	5,65	177	73	3	5,65	188	78
4	7,54	100	41	4	7,54	106	44
5	9,32	64	26	5	9,32	68	28

Gradian 1200X300

LED luminaire

	64 W	64 W	70 W	70 W
Power	64 W	64 W	70 W	70 W
Flux	4136 lm	4396 lm	6619 lm	7034 lm
CCT	3000 K	4000 K	3000 K	4000 K
CRI	=80 (min.)			
Color tolerance	MacAdam 4SDCM			
Service life	L70(10K)>50000h			
Beam			86°	86°
Efficiency			80%	80%
Efficacy	129 lm/W	137 lm/W	94 lm/W	100 lm/W

35 W 3000 K α=86° 4000 K α=86°

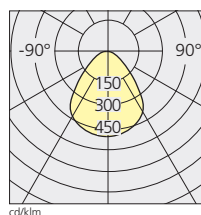

H m	Ø m	EMax lux	EM lux	H m	Ø m	EMax lux	EM lux
1	1,88	3190	1315	1	1,88	3390	1398
2	3,77	798	329	2	3,77	848	349
3	5,65	354	146	3	5,65	377	155
4	7,54	199	82	4	7,54	212	87
5	9,42	128	53	5	9,32	136	56

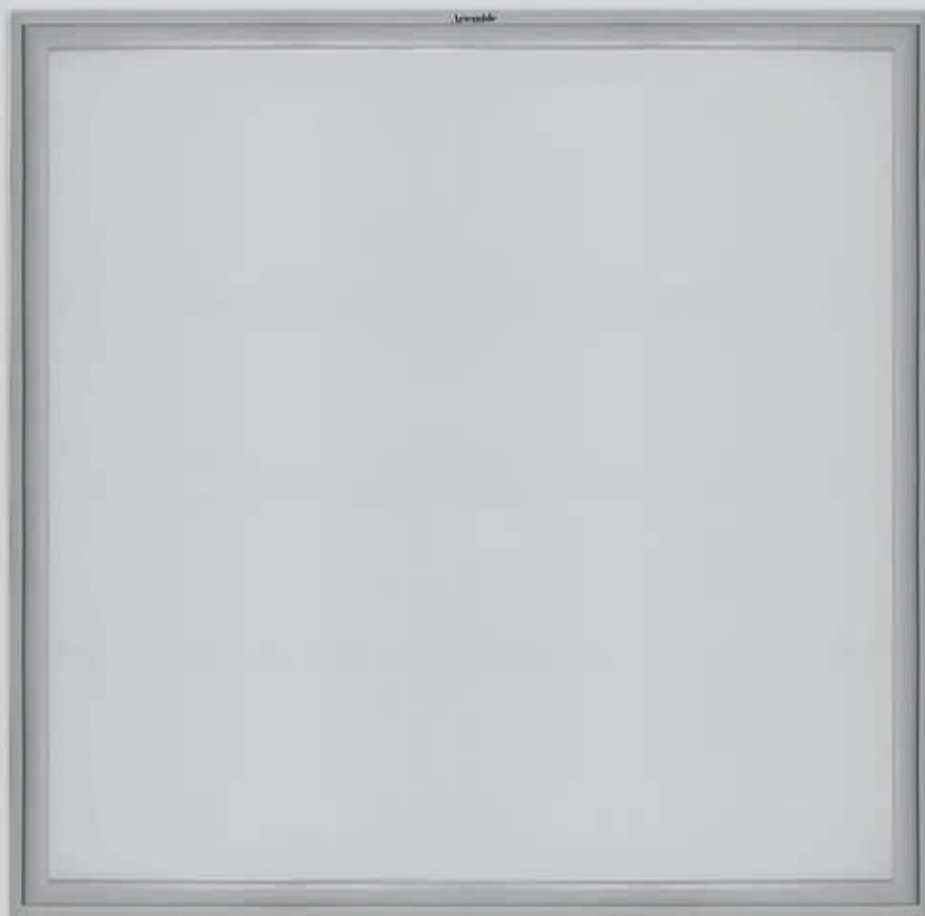

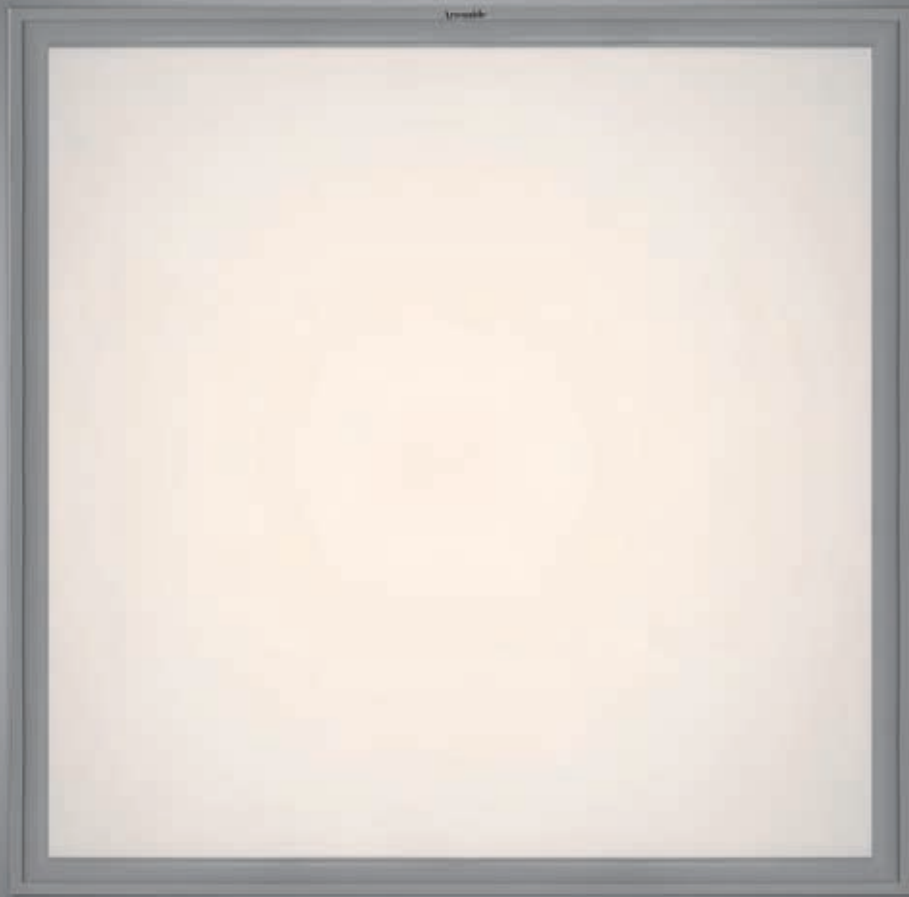



- Uglare is 600x600 and 625x625 recessed ceiling light, suited to illuminate working areas with video-terminals.
- Its strong steel and aluminium mechanical construction and high performance (over 100lm/W for the 4000K version), as well as the possibility to adjust the luminous flow, make this appliance ideal to illuminate work areas that require minimum incidence in terms of actual and perceived volumes of lighting systems.

Uglare19

Glossy white
○

600x600

W	Weight	Flux	CCT	Color	Code
35 W	3,90 kg	3309 lm	3000 K	○	M032500
		3517 lm	4000 K	○	M032600

220/240Vac 50/60Hz electronic ballast included.

625x625

W	Weight	Flux	CCT	Color	Code
35 W	3,90 kg	3309 lm	3000 K	○	M032700
		3517 lm	4000 K	○	M032800

220/240Vac 50/60Hz electronic ballast included.



IP40 Ⓢ IK10 650°

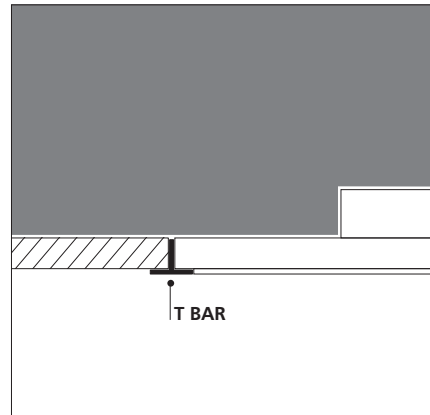
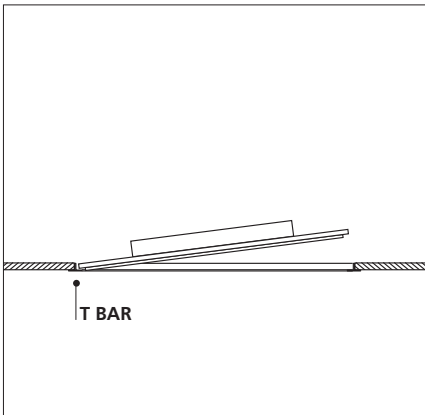
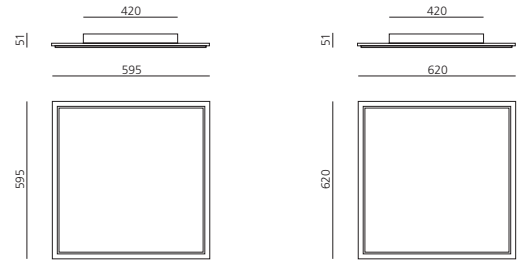

Installation with luminaire incorporated into the 600/625 modular ceiling structure.

UGLARE 19

LED

luminaire

35 W

Power	32W	32 W	35W	35 W
Flux	3361 lm	4136 lm	3309 lm	3517 lm
CCT	3000 K	4000 K	3000 K	4000 K
CRI	≈80 (typ.)			
Color tolerance	MacAdam 4SDCM			
Service life	L70(10K) > 50000h			
Beam			C0-C180	C0-C180
			87°	87°
			C90-C270	C90-C270
			87°	87°
UGR	<19	<19	<19	<19
Efficiency			80%	80%
Efficacy	129 lm/W	137 lm/W	94 lm/W	100 lm/W

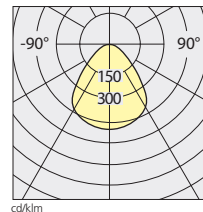

Chocolate terra LED

- Luminous flux distribution: Version 1 desk – 800x1600mm: Total flux produced consists of 35% direct emission and 65% indirect emission.
- Version 2 desk – 1600x1600mm: Total flux produced consists of 50% direct emission and 50% indirect emission.
- Available in warm white (3000K) and neutral white (4000K). CRI (indirect)= 80 (min). CRI (direct)=80 (typ).
- Two options of light management: dimmable with manual independent control of direct and indirect emission, or Interactive DALI system offering automatic control of illumination on the working plane. A single button allows you to set the desired light with Interactive DALI option.
- 2 colours: brown and white.
- Materials: head and stem in polished aluminium, base in polished aluminium, optics in metallized plastic, diffuser in clear polycarbonate.
- Compliant with standard EN60598-1 and other specific regulations.

Chocolate terra Fluo

- Floor lamp with direct-indirect lighting using 4x24 W or 6x24 W T16 and 2x55w TC-LEL light source.
- Optical unit and pole made of painted aluminum.
- Painted steel base.
- 2 colours: mocha and white.
- Optics made of transparent polycarbonate fitted with a prismoptic type diffuser.
- Light output ratio: 77% (TC-LEL version) and 67% (T16).
- Light distribution: 32% direct and 68% indirect (TC-LEL version), 34% direct and 66% indirect (T16).
- 4 levels of electronic light management depending on the version: electronic ballast with power switch, dimming control with manual light intensity adjustment, simple motion sensor with automatic on/off switching based on presence and light level, and interactive-dali system combining a movement detector and a daylight sensor for auto-regulation in relation to people presence and variations in daylight.
- Polycarbonate dust protection screen to be ordered separately.
- Complies with standard EN60598-1 and other specific standards.



Chocolate terra LED



The aluminium profile works as heat sink to dissipate heat.

Driver and components are located in the central compartment.

The 4 LEDs located in each corner are protected by an integral anti-dust screen.



The innovative optic system, specifically made with 108 micro-reflectors, allows a dazzle-free, controlled and concentrated light emission for single workspaces (800x1600mm, 1-desk version) or double workspaces (1600x1600mm, 2-desks version).

Chocolate terra LED 1-desk



Chocolate terra LED 2-desks





Chocolate terra LED

Brown ● White ○

LED 1 desk

W	Weight	Flux	CCT	Color
30 W	14 kg	1614 lm	3000 K	●
+ 51 W		+3772 lm		○
		1727 lm	4000 K	●
		+4036 lm		○

Dimmable

Code
M036211
M036221
M036311
M036321

Interactive Dali

Code
M036216
M036226
M036316
M036326



IP20 ☹

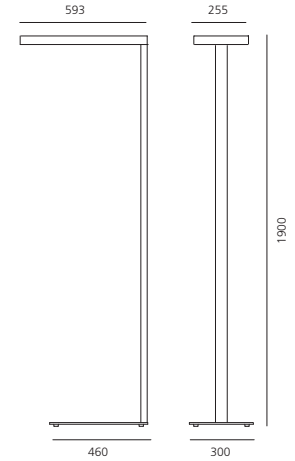

Chocolate terra 1 desk

LED direct

luminaire direct

Power	26 W	26 W	30 W	30 W
Flux	2510 lm	2686 lm	1614 lm	1727 lm
CCT	3000 K	4000 K	3000 K	4000 K
CRI	>80 (min.)		>80 (min.)	
Color tolerance	MacAdam 4SDCM			
Service life	L70(6K) > 36000h			
Efficiency			64%	64%
Efficacy	96 lm/W	103 lm/W	54 lm/W	58 lm/W

30 W

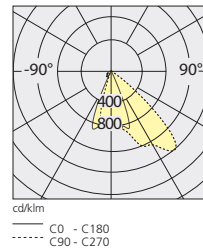

LED indirect

luminaire indirect

Power	44 W	44 W	51 W	51 W
Flux	3902 lm	4175 lm	3772 lm	4036 lm
CCT	3000 K	4000 K	3000 K	4000 K
CRI	>80 (min.)		>80 (min.)	
Color tolerance	MacAdam 3SDCM			
Service life	L70(6K) > 36000h			
Efficiency			96%	96%
Efficacy	89 lm/W	95 lm/W	74 lm/W	79 lm/W

51 W

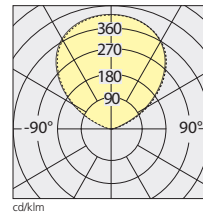

Direct emission

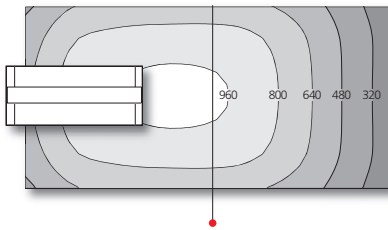

Indirect emission

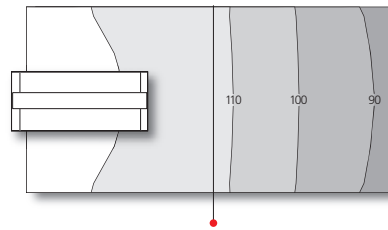

Double emission

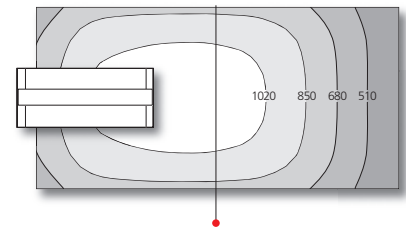

• UGR < 19 transversely to a table

Chocolate terra LED

Brown ● White ○

LED 2 desks

W	Weight	Flux	CCT	Color	Code	Code
45W	14 kg	2984 lm	3000 K	●	M036411	M036416
+50W		+ 3680 lm		○	M036421	M036426
		3193 lm	4000 K	●	M036511	M036516
		+ 3938 lm		○	M036521	M036526

Dimmable

Interactive Dali



IP20 ☹

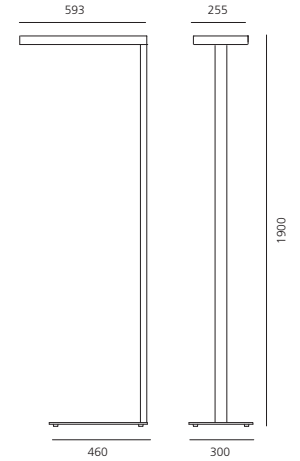

Chocolate terra 2 desks

Power
Flux
CCT
CRI
Color tolerance
Service life
Efficiency
Efficacy

LED direct	luminaire direct		
38 W	38 W	45 W	45 W
4070 lm	4355 lm	2984 lm	3193 lm
3000 K	4000 K	3000 K	4000 K
>80 (min.)			
MacAdam 4SDCM			
L70(6K) > 36000h			
		73%	73%
107 lm/W	115 lm/W	66 lm/W	71 lm/W

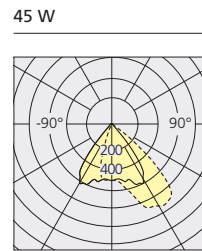

Power
Flux
CCT
CRI
Color tolerance
Service life
Efficiency
Efficacy

LED indirect	luminaire indirect		
43 W	43 W	50 W	50 W
3915 lm	4189 lm	3680 lm	3938 lm
3000 K	4000 K	3000 K	4000 K
>80 (min.)			
MacAdam 3SDCM			
L70(6K) > 36000h			
		94%	94%
91 lm/W	97 lm/W	74 lm/W	79 lm/W

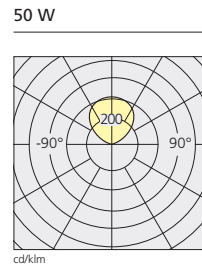

Direct emission

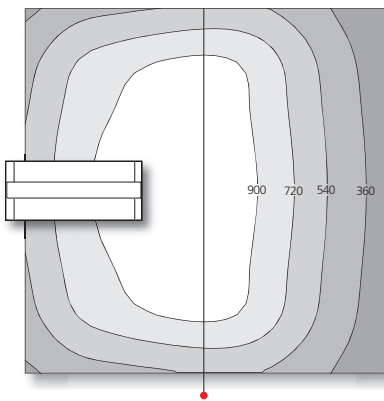

Indirect emission

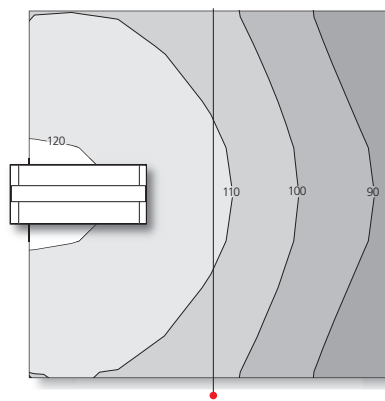

Double emission

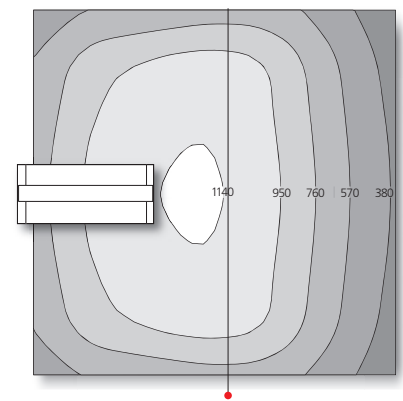

• UGR < 19 transversely to a table



Chocolate terra fluo

● Mocha ○ White

T16 (G5)

W	Weight	Flux	Color
4x24W	13,70Kg	7000 lm	● ○
6x24W	14,00Kg	10500 lm	● ○

Non dimmable

Code
M163910
M163920
M164110
M164120

Dimmable

Code
M163911
M163921
M164111
M164121



IP20 ☺ 850°

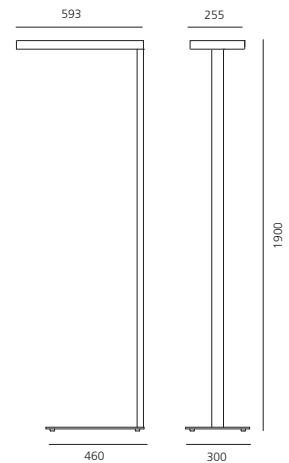

W	Weight	Flux	Color
4x24W	13,70Kg	7000 lm	● ○
6x24W	14,00Kg	10500 lm	● ○

Interactive-Dali

Code
M163916
M163926
M164116
M164126

Motion detector

Code
M163919
M163929
M164119
M164129

T16

4x24W Efficiency 67%
6x24W Efficiency 66%

4x24W 7000 lm

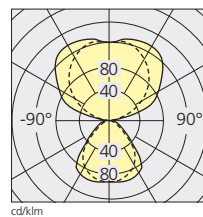

6x24W 10500 lm

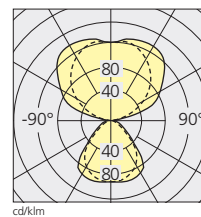

Accessories



Polycarbonate dust protection screen (set of 2).

Code
M164200



Interactive-Dali remote control.

M104900

Isolux

Calculation parameters to issue isolux curve diagrams: Office with one work station.
Length x width x height 5,00x5,00x2,70m.
Reflectance factors ceiling/walls/floor 70/50/20%.
Working plan 1,60x0,80x0,75m.
Maintenance factor 0,90WF.

Chocolate floor T16

T16 (G5) 4x24W.
Em (desk) 382lux.

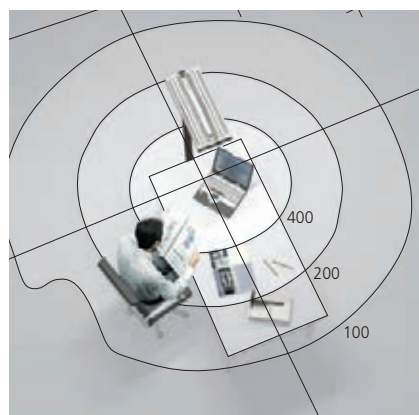

1m 0m 1m 2m

T16 (G5) 6x24W.
Em (desk) 606lux.

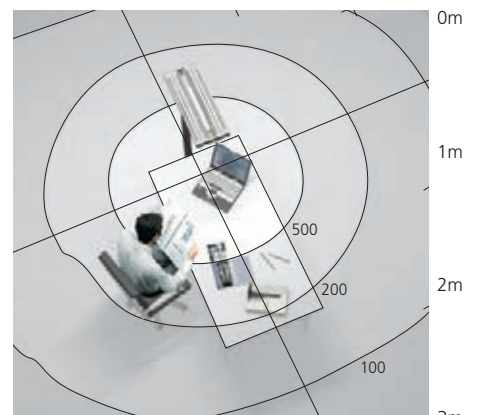

1m 0m 1m 2m



Chocolate floor TC-LEL has been certified according to the Swiss top-quality Minergie® standard.

● Mocha ○ White

TC-LEL (2G11)

W	Weight	Flux	Color
2x55 W	13,70Kg	9600 lm	● ○

Non dimmable

Code
M163810
M163820

Dimmable

Code
M163811
M163821

Interactive-Dali

Color	Code
●	M163816
○	M163826



IP20 ⊕ 850°

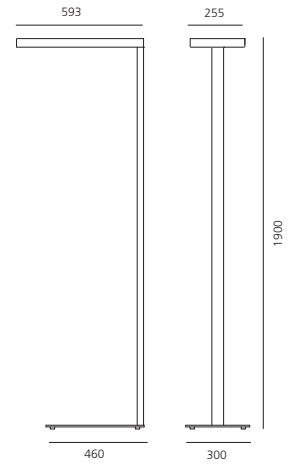

TC-LEL

Efficiency 77%

2x55W 9600 lm

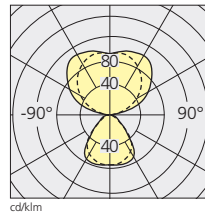

Accessories



Polycarbonate dust protection screen (set of 2).

Code M164200



Interactive-Dali remote control.

M104900

Chocolate floor TC-LEL

TC-LEL (2G11) 2x55W.
Em (desk) 501lux.

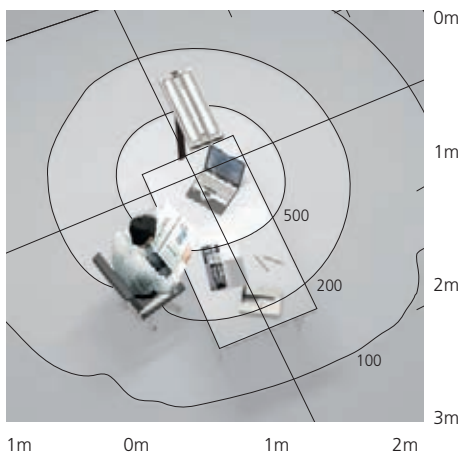

Chocolate sospensione

a-g Licht
2009

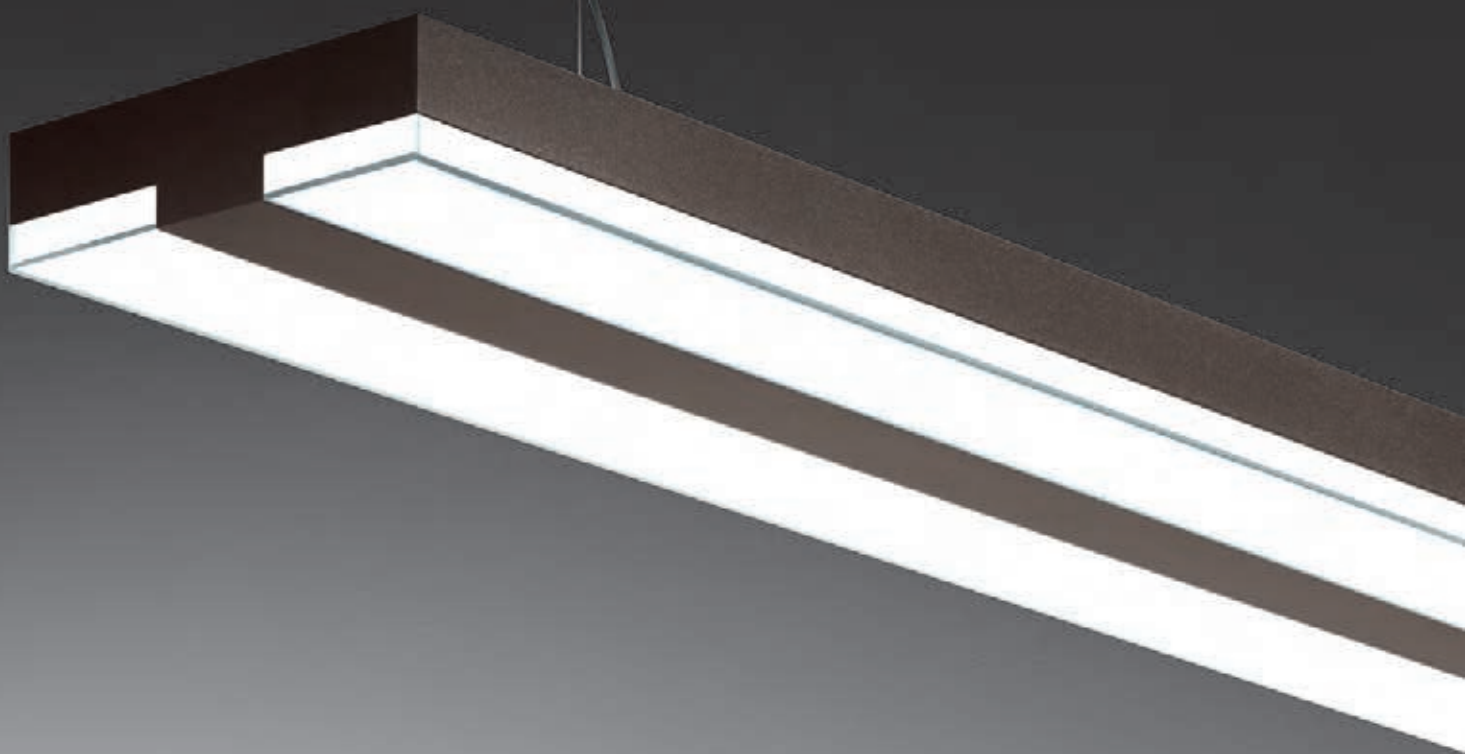

- Single pendant light with direct-indirect lighting using Led and 2x28 W and 2x54 W T16 fluorescent lamps.
- Aluminium body.
- 2 colours: mocha and white.
- Optics made of transparent polycarbonate fitted with a prismoptic diffuser.
- Electronic control gear, or Dali-SwitchDim dimmable electronic control gear. Emergency lighting on request.
- Polycarbonate dust protection cover.
- Quick adjustment steel suspension cables.
- Complies with standard EN60598-1 and other specific standards.

Chocolate suspensione

Mocha ● White ○

LED				
W	Weight	Flux	CCT	Color
63 W	4,6Kg	3868 lm	3000 K	●
		4136 lm	4000 K	○

Non dimmable	
Code	
M113610	
M113620	
M113710	
M113720	

Dali dimmable	
Code	
M113611	
M113621	
M113711	
M113721	



220/240Vac 50/60Hz electronic ballast included.

IP20 850°

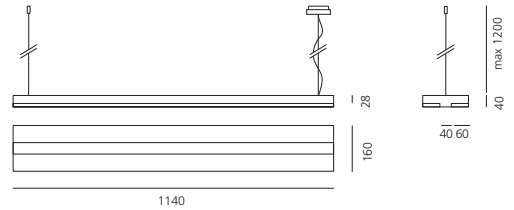

	LED		luminaire	
	55 W	55 W	63 W	63 W
Power	8230 lm	8800 lm	3868 lm	4136 lm
Flux	3000 K	4000 K	3000 K	4000 K
CCT	=80 (min.)			
CRI	MacAdam 4SDCM			
Color tolerance	L70(6K) > 50000h			
Service life			47%	47%
Beam	150 lm/W	160 lm/W	61 lm/W	66 lm/W
Efficiency				
Efficacy				

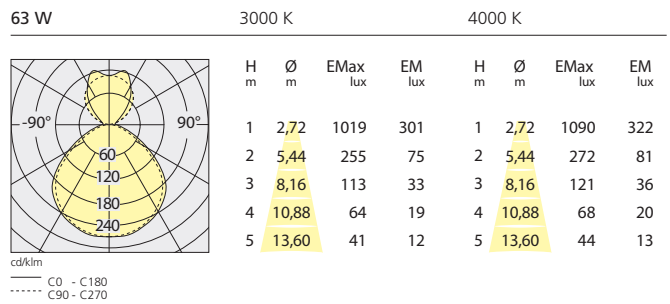

T16 (G5)				
W	EC	Weight	Flux	Color
2x28 W	1	1,9Kg	5200 lm	●
			8900 lm	○

Non dimmable	
Code	
M164710	
M164720	
M164810	
M164820	

Dali-SwitchDim	
Code	
M164811	
M164821	

220/240Vac 50/60Hz electronic ballast included.

T16		
Efficiency		
64%	2x54 W	4450 lm
	2x28 W	2600 lm

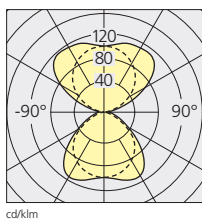

Chocolate parete

a-g Licht
2008



- Wall lamp with direct-indirect lighting using LED or 2x24 W and 3x24 W T16 fluorescent light source.
- Painted aluminum body.
- 2 colours: mocha and white.
- Optics made of transparent polycarbonate fitted with a prismoptic type diffuser.
- Electronic control gear
- Polycarbonate dust protection screen.
- Complies with standard EN60598-1 and other specific standards.

Chocolate parete

Mocha ● White ○

LED L 585

Non dimmable

W	Weight	Flux	CCT	Color
16 W	1,9Kg	1210 lm	3000 K	●
				○
			4000 K	●
				○

Code
M112410
M112420
M112510
M112520

220/240Vac 50/60Hz electronic ballast included.

LED L 1145

Non dimmable

W	Weight	Flux	CCT	Color
31 W	3,7Kg	2262 lm	3000 K	●
				○
		2420 lm	4000 K	●
				○

Code
M112610
M112620
M112710
M112720

220/240Vac 50/60Hz electronic ballast included.



IP20

850°

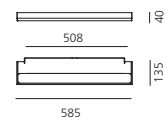
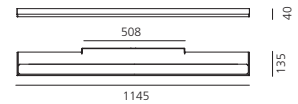

L 585

LED luminaire

	14 W	14 W	16 W	16 W
Power	14 W	14 W	16 W	16 W
Flux	2200 lm	2200 lm	1210 lm	1210 lm
CCT	3000 K	4000 K	3000 K	4000 K
CRI	=80 (min.)			
Color tolerance	MacAdam 3SDCM			
Service life	L70(6K) > 50000h			
Beam				
Efficiency			55%	55%
Efficacy	157 lm/W	157 lm/W	76 lm/W	78 lm/W

16 W

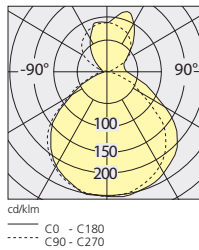

LED luminaire

	28 W	28 W	31 W	31 W
Power	28 W	28 W	31 W	31 W
Flux	4140 lm	4400 lm	2262 lm	2420 lm
CCT	3000 K	4000 K	3000 K	4000 K
CRI	=80 (min.)			
Color tolerance	MacAdam 4SDCM			
Service life	L70(6K) > 50000h			
Beam				
Efficiency			55%	55%
Efficacy	148 lm/W	157 lm/W	73 lm/W	78 lm/W

31 W

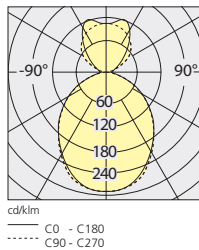

3000 K

4000 K

	H m	Ø m	EMax lux	EM lux	H m	Ø m	EMax lux	EM lux
1	2,23	636	210	1	2,23	681	224	
2	4,45	159	52	2	4,45	170	56	
3	6,68	71	23	3	6,68	76	25	
4	8,91	40	13	4	8,91	43	14	
5	11,13	25	8	5	11,13	27	9	

T16 (G5)

Non dimmable

W	Weight	Flux	Color
2x24 W	1,9Kg	3500 lm	●
			○
3x24W	1,9Kg	5250 lm	●
			○

Code
M164510
M164520
M164610
M164620

Polycarbonate dust protection screen included.



IP20

850°

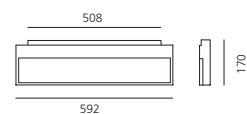

T16

2x24W

3500 lm

3x24W

5250 lm

Efficiency 60%

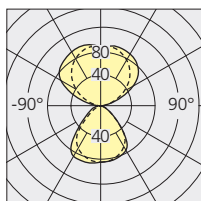
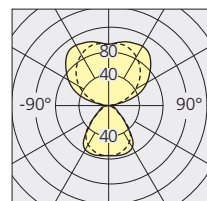

Esprit

Giovanni Giacobone
Massimo Roj
2007





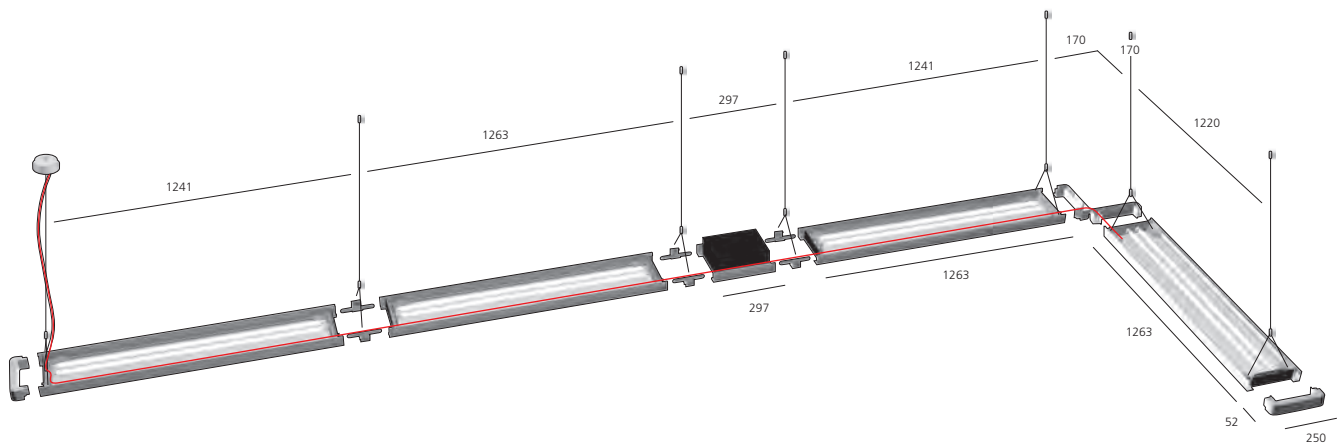

- Pendant system with indirect and direct-indirect lighting using 2x54w t16 fluorescent lamps.
- Available as a single pendant light or as a modular system.
- The structure consists of an aluminium frame with a metallic grey paint finish and a central optical element.
- End caps in die-cast aluminium.
- Indirect lighting version equipped with an opaque screen with an exclusive black crystal lacquered finish.
- Light output ratio: 59% (indirect lighting version) and 89% (direct-indirect lighting version).
- Light distribution: 85% indirect and 15% direct.
- Electronic ballast, or dali-switchdim dimmable electronic ballast, and emergency lighting.
- Intermodule mechanical connection by linear or 90° connectors.
- Quick adjustment steel suspension cables.
- Mini modules for the installation of auxiliary services: accent lighting, video, sound, smoke detectors, etc.
- Complies with standard EN60598-1 and other specific standards.

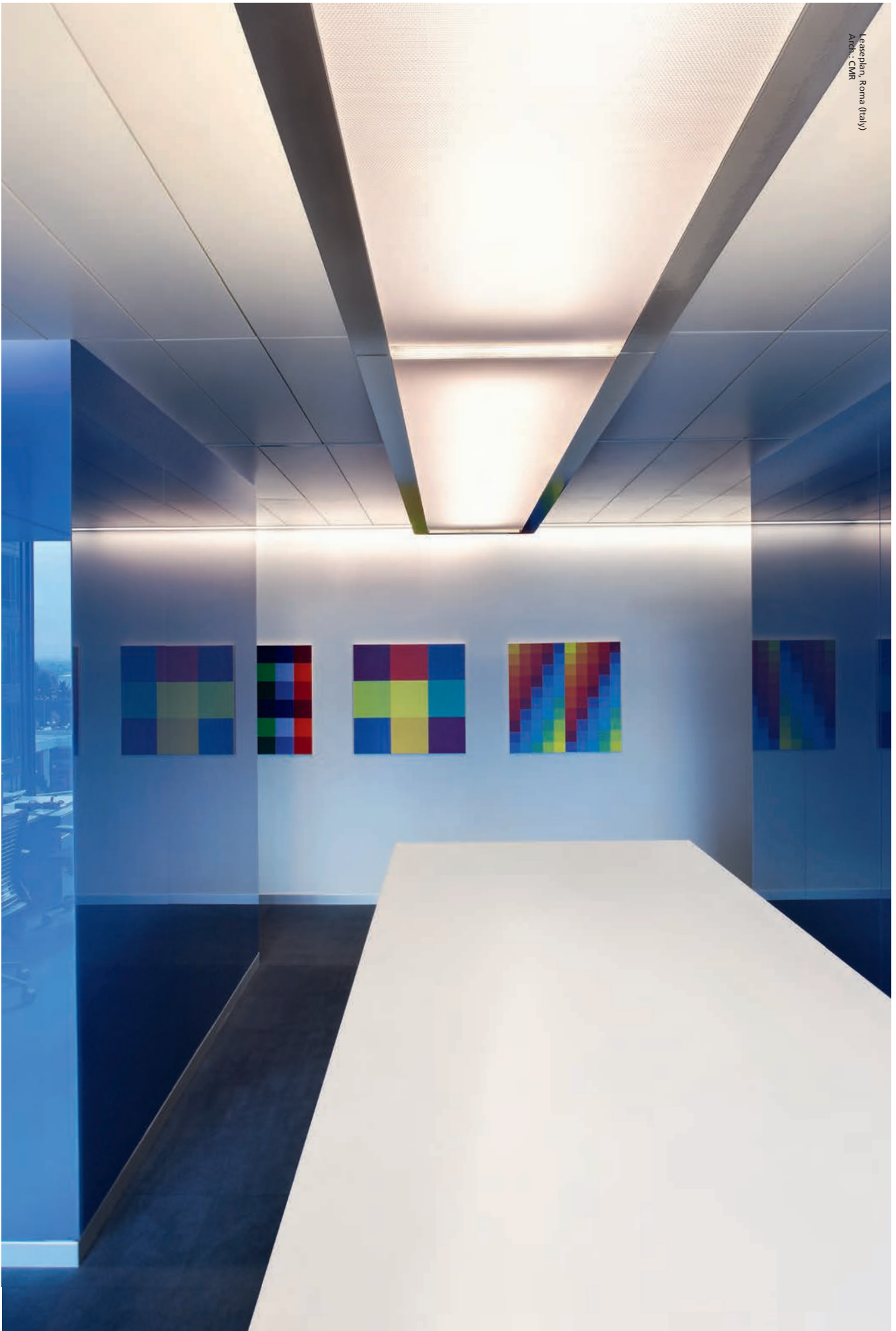

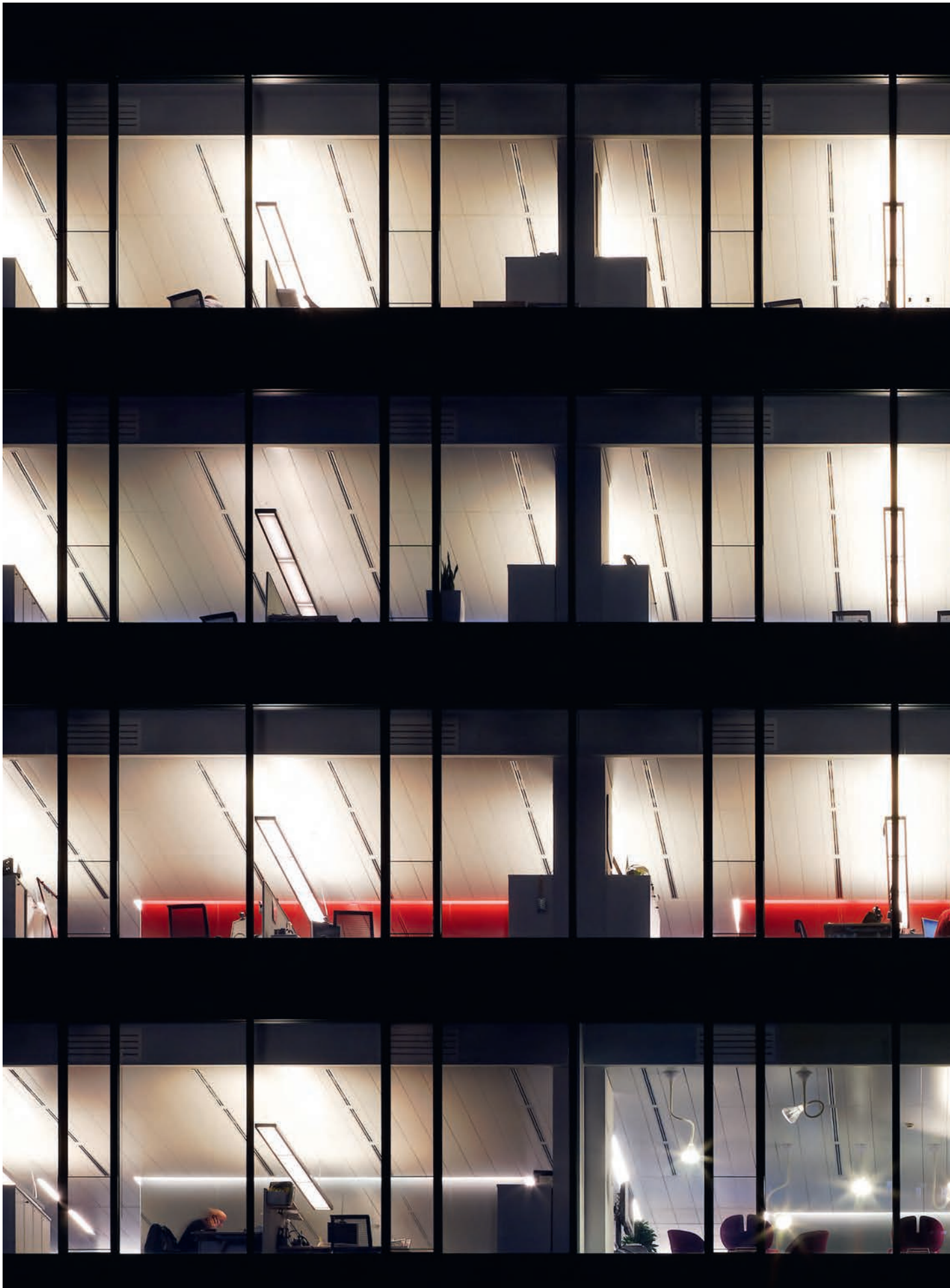





T16 (G5) indirect emission

W	Weight	Flux	Color
2x54 W	5,7 kg	8900 lm	●
2x28 W	5,7 kg	5200 lm	●

Non dimmable

Code
M155000

Dali dimmable

Code
M155001
M155001

220/240Vac 50/60Hz electronic ballast included.

+ emergency 1h

Color	Code
●	M155007



T16 (G5) dual emission

W	Weight	Flux	Color
2x28 W	5,7 kg	8900 lm	●
2x54 W	5,7 kg	5200 lm	●

Non dimmable

Code
M155100

Dali dimmable

Code
M155101
M155101

IP20 ☉

850°

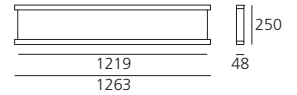

220/240Vac 50/60Hz electronic ballast included.

+ emergency 1h

Color	Code
●	M155107

T16

Efficiency 89%	2x54 W	8900 lm
	2x28 W	5200 lm

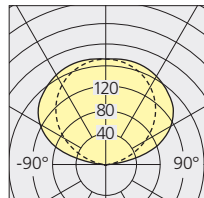

cd/klm

T16

Efficiency 89%	2x54 W	8900 lm
	2x28 W	5200 lm

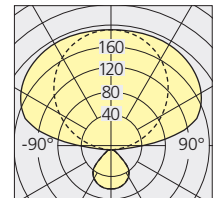

cd/klm

Components



Downlighter module
QR-CBC51 (GU5,3) 1xmax50 W / 12V.
Integral electronic transformer.
Dimmable by trailing edge external dimmers.
297x250x100mm.



Unwired module for auxiliary service.
297x250x48mm.



Unwired module for auxiliary service.
297x250x100mm.



End cap (set of 2).
250x52x48mm.

Code
M155600

M156000

M156100

M156200

Components



Linear connector.



L-shaped connector.
296x296x48mm.



Steel suspension cable.
1200mm.



Suspension cable with power supply.
Ceiling plate - Ø100mm. 1200mm.
3-pole (3x1,5mm²)
5-pole (5x1,5mm²)

Code
M156300

M156400

M108320

M156600
M156700

Esprit suspension

Metal grey
●

T16 (G5) indirect emission

W	Weight	Flux	Color
2x54 W	5,7 kg	8900 lm	●
2x28 W	5,7 kg	5200 lm	●

Non dimmable

Code
M154500

Dali dimmable

Code
M154501
M154501

220/240Vac 50/60Hz electronic ballast included.



T16 (G5) dual emission

W	Weight	Flux	Color
2x28 W	5,7 kg	8900 lm	●
2x54 W	5,7 kg	5200 lm	●

Non dimmable

Code
M154600

Dali dimmable

Code
M154601
M154601

220/240Vac 50/60Hz electronic ballast included.

IP20 ⊕

850°

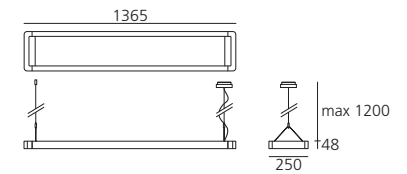

T16

Efficiency 89%

2x54 W
2x28 W

8900 lm
5200 lm

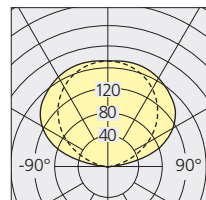

cd/klm

T16

Efficiency 89%

2x54 W
2x28 W

8900 lm
5200 lm

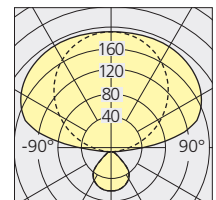

cd/klm



Surf System

Neil Poulton
1998





Surf System

Surf System suspension

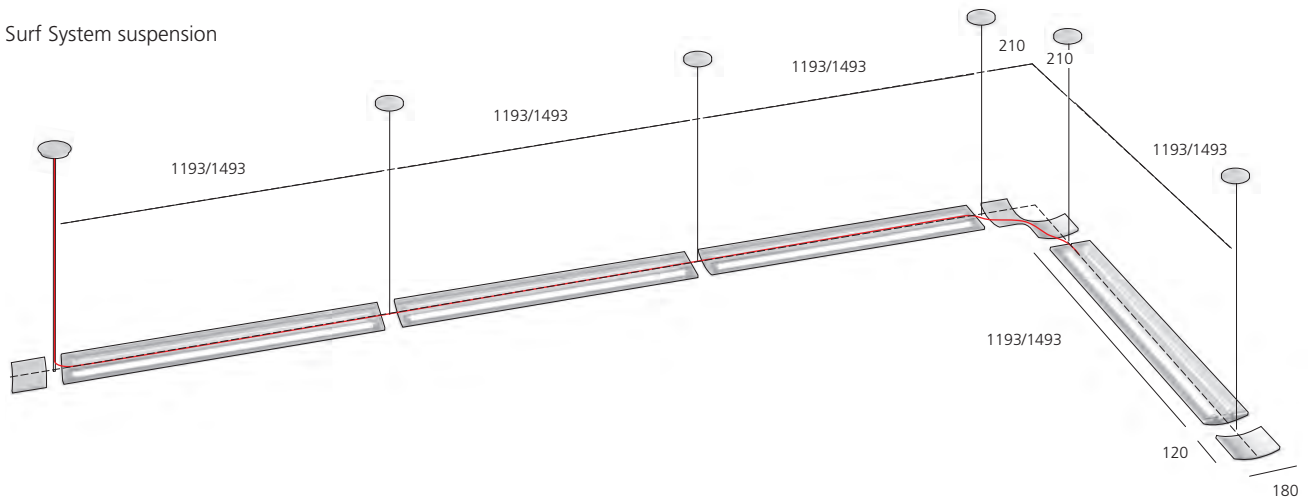

Surf System wall

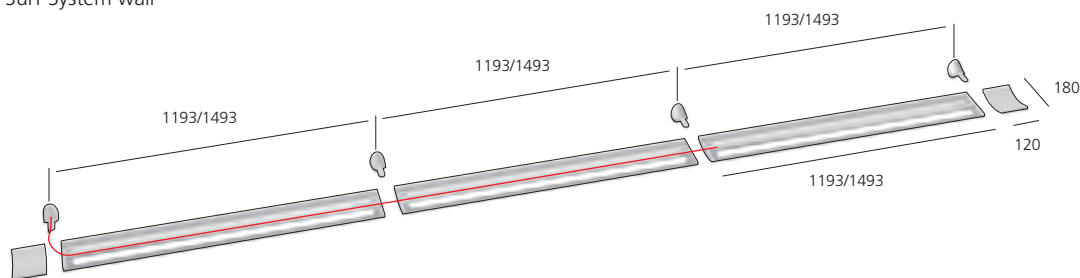

Surf System LED

- High-performing LED modular system with indirect emission.
- Available in warm white (3000 K) and neutral white (4000 K) – CRI=80 (typ).
- Ceiling-mounted or suspended.
- Single installation, in line or angled (L-shaped / 90°, 2-ways, 3-ways, 4-ways).
- Non-dimmable electronic power supply, DALI dimmable or interactive DALI system, combining presence detector and daylight sensor.
- Materials: white or grey painted extruded aluminium body, extruded polycarbonate dust-protective screen.
- ‘Quick’-adjustable steel suspension cables.
- Compliant to standard EN62471, EN60598-1 and other specific regulations.

Surf System Fluo

- Modular system for indirect lighting using 2x14 W to 2x80 W T16 fluorescent lamps.
- Extruded aluminium body with a white or grey paint finish.
- Can be installed as a pendant light (surf system suspension) or wall light (surf system wall).
- Continuous linear mounting or with 90° connectors, 3 and 4 ways connectors.
- Light output ratio: 72%.
- Electronic ballast, or dali-switchdim dimmable electronic ballast, or interactive-dali system combining a movement detector and a daylight sensor for auto-regulation in relation to people presence and variations in daylight. Emergency lighting as an optional extra.
- Dust protection cover made of extruded polycarbonate.
- Quick adjustment steel suspension cables.
- Complies with standard EN60598-1 and other specific standards.



LED

W	Length	Weight	Flux	CCT	Color
65 W	1193 mm	5,10 kg	6305 lm	3000 K	○
			6635 lm	4000 K	●

non dimmable

Code
M095120
M095190
M095220
M095290

Dali dimmable

Code
M095121
M095191
M095221
M095291

220/240Vac 50/60Hz electronic ballast included.

Surf System

LED

luminaire

65 W

Power	58 W	58 W	65 W	65 W
Flux	7460 lm	7850 lm	6305 lm	6635 lm
CCT	3000 K	4000 K	3000 K	4000 K
CRI	=80 (typ.)			
Color tolerance	MacAdam 4SDCM			
Service life	L70(6K) > 50000h			
Efficiency			85%	85%
Efficacy	130 lm/W	135 lm/W	98 lm/W	103 lm/W

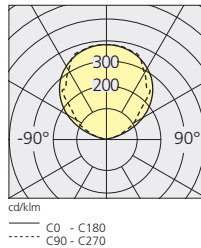

T16 (G5)

	Length	Weight	Flux		Color
2x14 W	593 mm	2,50 kg	2400 lm		○
2x28 W	1193 mm	3,60 kg	3200 lm		○
2x35 W	1493 mm	4,50 kg	6600 lm		○
2x54 W	1193 mm	3,60 kg	8900 lm		○
2x80 W	1493 mm	4,50 kg	12300 lm		○

Non dimmable

Code
M091520
M091590
M090020
M090090
M090120
M090190
M094520
M094590
M094620
M094690

Dali-SwitchDim

Code
M094720
M094790
M094820
M094890
M094925
M094995
M091125
M091195

Interactive-Dali

Code
M094926
M094996

220/240Vac 50/60Hz electronic ballast included.
Surf module 2x80W is equipped with 2 power supplies and therefore it occupies 2 DALI addresses.

T16 (G5)

	Length	Weight	Flux	Color
2x24 W	1193 mm	3,60 kg	2500 lm	○
2x28 W	1773 mm	5,60 kg	3200 lm	○
2x35 W	2073 mm	6,50 kg	6600 lm	○

+ emergency 1h

Code
M097620
M097690
M091220
M091290
M091320
M091390

220/240Vac 50/60Hz electronic ballast included.

T16

Efficiency 72%

2x14 W	2400 lm
2x28 W	3200 lm
2x35 W	6600 lm
2x54 W	8900 lm
2x80 W	12300 lm

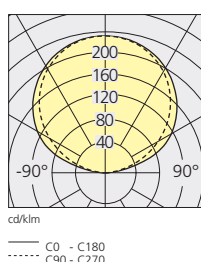

White
○
Grey
●







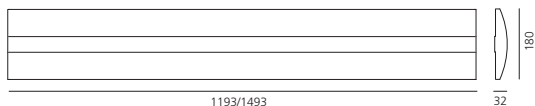



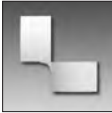

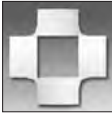
IP20 ☉

960°



Accessories

	Color	Code
 End cap 120x180 mm 0,70 kg	○ ●	M090220 M090290
 L-shaped connector 300x300 mm 1,50 kg	○ ●	M090320 M090390
 3-way connector 421x300 mm 2,30 kg	○ ●	M090420 M090490
 4-way connector 421x421 mm 3,00 kg	○ ●	M090520 M090590
 Steel suspension cable ceiling plate ø100 mm	○ ●	M090620 M090690
 3 core suspension cable (3x1,5 mm ²) ceiling plate ø100 mm L 1100 mm	○ ●	M090720 M090790
 5 core suspension cable (3x1,5 mm ² + 2x0,5 mm ²) ceiling plate ø100 mm L 1100 mm	○ ●	M091820 M091890
 Wall fixing without power supply 55x90 mm protusion 50 mm	○ ●	M090820 M090890
 Wall fixing with power supply (3x1,5 mm ²) 55x90 mm protusion 50 mm	○ ●	M090920 M090990
 Interactive-Dali remote control		M104900
 Interactive-Dali kit ø86mm, white, recessed. Can be connected to a max. 11 Dali dimnable units (slave modules). Operated through an Interactive-Dali remote control or optional.		M074030
 Recessed motion sensor for Interactive-Dali system.	○ ●	M074130

○ ø72

○ ø64





Surf wall

Neil Poulton
1998

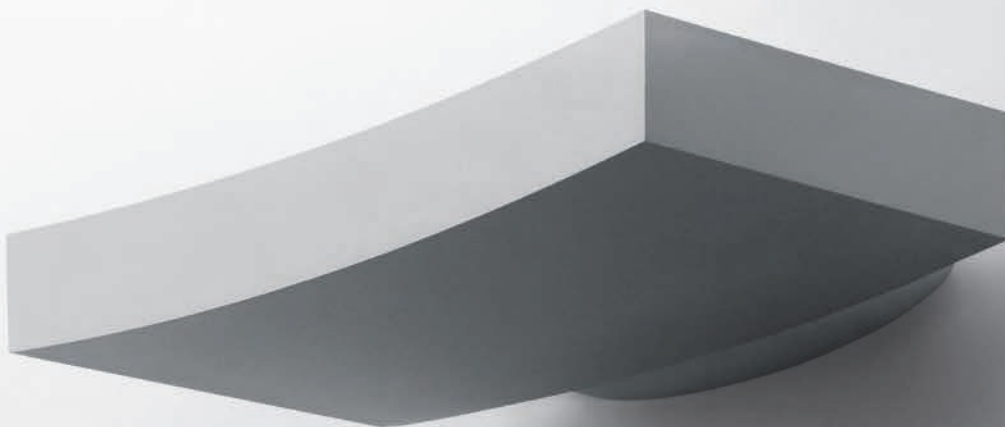

- High-performing LED wall-mounted light fitting.
- More than 3,400 lm flux installed.
- High efficiency: more than 70 lumen per watt.
- Available in warm white (3000K) and neutral white (4000K) – CRI=80 (typ).
- Materials: body in white or grey painted aluminium.
- Non-dimmable electronic power supply or dimmable Dali-SwitchDim options.
- Compliant to standard EN62471, EN60598-1 and other specific regulations.
- A range of wall lamps with indirect lighting, using 300 W halogen, 150 W metal-halide and 1x18 W, 2x36 W and 2x55 W TC-LEL fluorescent lamps.
- Aluminium body with white or grey paint finish.
- 3 size options: 174x300mm, 290x460mm and 290x600mm.
- Electronic ballast.
- Protective glass (for halogen and metal-halide versions) or polycarbonate dust-protection screen (for 2x36-55W TC-LEL versions).
- Complies with standard EN60598-1 and other specific standards.



Surf wall

White Grey

Surf wall 300

LED

W	Weight	Flux	CCT	Color
35 W	1,40 kg	2930 lm	3000 K	<input type="radio"/>
		3078 lm	4000 K	<input checked="" type="radio"/>

non dimmable

Code
M060120
M060190
M060220
M060290

Dali-SwitchDim

Code
M060121
M060191
M060221
M060291



220/240Vac 50/60Hz electronic ballast included.

LED

luminaire

37W

Power	31 W	31 W	35 W	35 W
Flux	3433 lm	3605 lm	2930 lm	3078 lm
CCT	3000 K	4000 K	3000 K	4000 K
CRI	=80 (typ.)			
Color tolerance	MacAdam 3SDCM			
Service life	L70(6K) > 50000h			
Efficiency			85%	85%
Efficacy	110 lm/W	116 lm/W	80 lm/W	84 lm/W

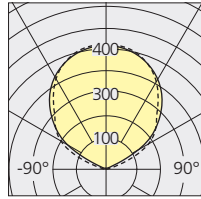

cd/klm
 — C0 - C180
 - - - C90 - C270

IP20 ☹

960°

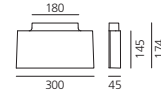

QT-DE12 (R7s)

W	Weight	Flux	Color
max 300 W	1,00 kg	5000 lm	<input type="radio"/>
			<input checked="" type="radio"/>

Code
M060955
M060966

QT-DE12

Efficiency 64% 300 W 5000 lm

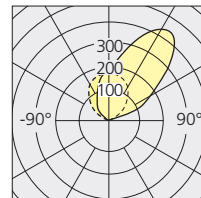

cd/klm
 — C0 - C180
 - - - C90 - C270

TC-LEL (2G11)

W	Weight	Flux	Color
18 W	1,00 kg	1200 lm	<input type="radio"/>
			<input checked="" type="radio"/>

Code
M066355
M066366

TC-LEL (2G11)

Efficiency 63% 18 W 1200 lm

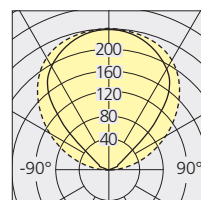

cd/klm
 — C0 - C180
 - - - C90 - C270

Surf wall

White Grey

Surf wall 460

TC-LEL (2G11)

W	Weight	Flux	Color	Code
2x36 W	1,40 kg	5800 lm	<input type="radio"/>	M061520
			<input checked="" type="radio"/>	M061590

220/240Vac 50/60Hz electronic ballast included.

TC-LEL

Efficiency 56% 36 W 5800 lm

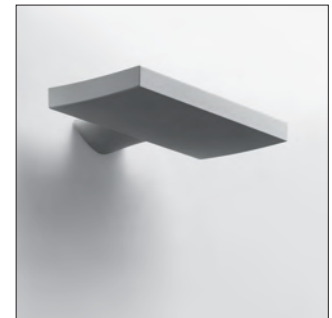
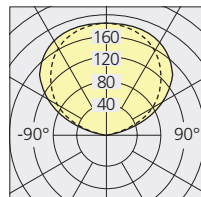

IP20

960°

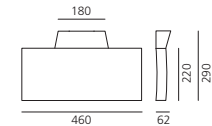

HIT-DE-CE-h45 (RX7s)

W	Weight	Flux	Color	Code
150 W	3,80 kg	11250 lm	<input type="radio"/>	M066220
			<input checked="" type="radio"/>	M066290

HIT-DE-CE-h45

Efficiency 61% 150 W 11250 lm

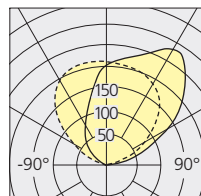

Surf wall 600

TC-LEL (2G11)

W	Weight	Flux	Color	Code
2x55 W	1,80 kg	4800 lm	<input type="radio"/>	M060720
			<input checked="" type="radio"/>	M060790

220/240Vac 50/60Hz electronic ballast included.

TC-LEL

Efficiency 53% 55 W 4800 lm

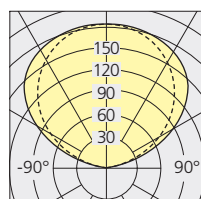

IP20

960°

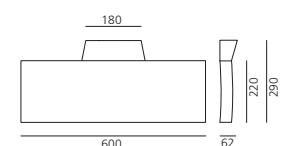

Kalifa terra

Ernesto Gismondi
2005

- A range of floor lamps with direct-indirect lighting using 55w and 80w TC-LEL fluorescent lamps.
- Optical unit and pole in extruded aluminium with a white or grey paint finish.
- Steel base.
- 3 versions: comfort, dark light and prismoptic.
- 4mm thick screen-printed tempered glass comfort diffuser: light distribution: 87% indirect and 13% direct.
- Aluminium dark light optic: light output ratio 62%. light distribution: 73% indirect and 27% direct.
- Polycarbonate prismoptic diffuser: light output ratio of up to 71%. light distribution: 76% indirect and 24% direct (kalifa floor prismoptic iii).
- 4 levels of electronic light management: electronic ballast with twin switch (50%/100%), dimming control with manual light intensity adjustment, simple motion sensor with automatic on/off switching based on presence and light level, and interactive-dali system combining a movement detector and a daylight sensor for auto-regulation in relation to people presence and variations in daylight.
- Polycarbonate dust-protection screen as an optional extra.
- Complies with standard EN60598-1 and other specific standards.



Kalifa terra comfort

White Grey

TC-LEL (2G11)

W	Weight	Stand	Flux	Color
4x55 W	15 kg	middle	19200 lm	<input type="radio"/>
	15 kg	lateral	19200 lm	<input type="radio"/>

Non dimmable

Code
M168020
M168090
M167820
M167890

Dimmable

Code
M168021
M168091
M167821
M167891

Interactive Dali

Code
M168026
M168096
M167826
M167896

Presence detector

Code
M168029
M168099
M167829
M167899

Stand	Flux	Color
middle	19200 lm	<input type="radio"/>
lateral	19200 lm	<input type="radio"/>



IP20

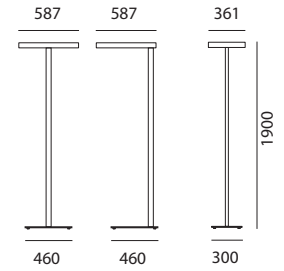

UGR<19
L<3000 cd/m² @65°

4x55 W / 19200 lm Efficiency 68% α=82°

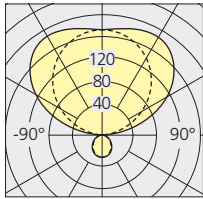

Cd/Klm
--- C0 - C180
..... C90 - C270

Components



Polycarbonate dust-protection screen for Kalifa floor comfort and dark light

Code
M168200



Interactive-Dali remote control

M104900

Isolux

Calculation parameters to issue isolux diagrams:
Office with one work station.
Length x width x height 5,00x5,00x2,70m.
Reflectance factors ceiling/walls/floor: 70/50/20%.
Working plane 1,60x0,80x0,75m.
Maintenance factor 0,90WF.

Kalifa terra comfort

TC-LEL (2G11) 4x55W.
Em (desk) 372lux.

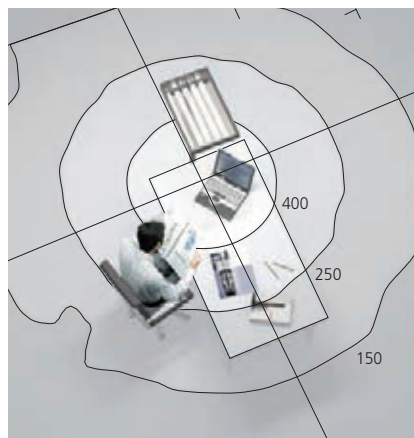

1m 0m 1m 2m

Kalifa terra controlled emission

White Grey

TC-LEL (2G11)

W	Weight	Stand	Flux	Color
4x55 W	15 kg	middle	19200 lm	<input type="radio"/>
	15 kg	lateral	19200 lm	<input type="radio"/>

Stand	Flux	Color
middle	19200 lm	<input type="radio"/>
lateral	19200 lm	<input type="radio"/>

Non dimmable

Code
M168520
M168590
M168620
M168690

Dimmerabile

Code
M168521
M168591
M168621
M168691

Interactive Dali

Code
M168526
M168596
M168626
M168696

Presence detector

Code
M168529
M168599
M168629
M168699



IP20

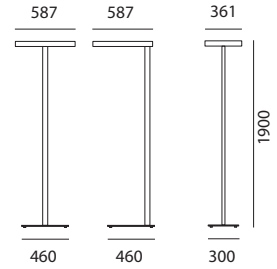

UGR<19
L<3000 cd/m² @65°

4x55 W /19200 lm Efficiency 62% α=94°

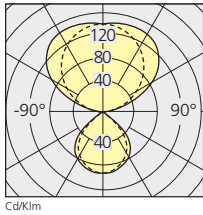

H m	Ø m	EMax lux	EM lux
1	2,16	1807	285
2	4,32	452	71
3	6,48	201	32
4	8,64	113	18
5	10,80	72	11

— C0 - C180
- - - C90 - C270

Components



Polycarbonate dust-protection screen for Kalifa floor comfort and dark light

Code
M168200



Interactive-Dali remote control

M104900

Isolux

Calculation parameters to issue isolux diagrams:
Office with one work station.
Length x width x height 5,00x5,00x2,70m.
Reflectance factors ceiling/walls/floor: 70/50/20%.
Working plane 1,60x0,80x0,75m.
Maintenance factor 0,90WF.

Kalifa terra controlled emission

TC-LEL (2G11) 4x55W.
Em (desk) 927lux.

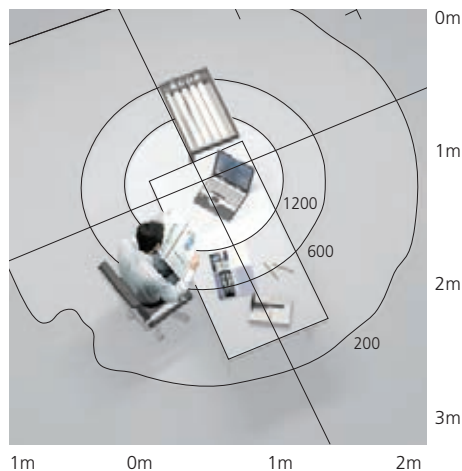





CB Richard Ellis, Frankfurt/Main (Germany)
Photo: Fabian Aureli Hüb

Kalifa terra prismoptic I

White Grey

TC-LEL (2G11)

W	Weight	Stand	Flux	Color
4x55 W	14 kg	lateral	19200 lm	<input type="radio"/> <input type="radio"/>

Non dimmable

Code
M168420
M168490

Dimmable

Code
M168421
M168491

Interactive Dali

Color	Code
<input type="radio"/>	M168426
<input type="radio"/>	M168496

Presence detector

Code
M168429
M168499



UGR<19
L<3000 cd/m² @65°

4x55 W /19200 lm Efficiency 70% α=86°

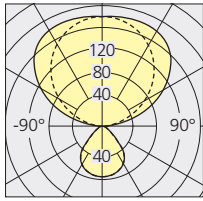

H _m	Ø _m	E _{Max} lux	E _M lux
1	1,88	1444	281
2	3,76	361	70
3	5,63	160	31
4	7,51	90	18
5	9,39	58	11

— C0 - C180
- - - C90 - C270

IP20

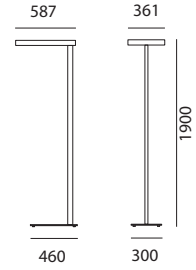

Components



Interactive-Dali
remote control

Code
M104900

Kalifa terra prismoptic I
TC-LEL (2G11) 4x55W.
Em (desk) 854 lux.

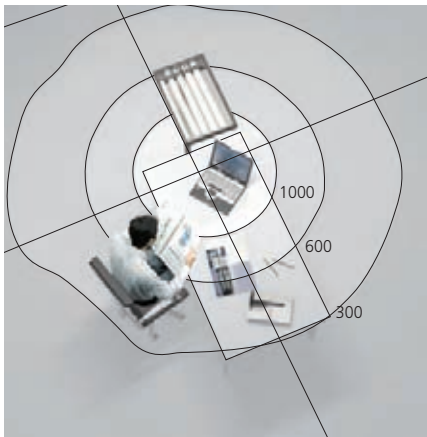

Isolux

Calculation parameters to issue isolux diagrams:
Office with one work station.
Length x width x height 5,00x5,00x2,70m.
Reflectance factors ceiling/walls/floor: 70/50/20%.
Working plane 1,60x0,80x0,75m.
Maintenance factor 0,90WF.

Kalifa terra prismoptic II

White Grey

TC-LEL (2G11)

W	Weight	Stand	Flux	Color
4x55 W	14 kg	middle	19200 lm	<input type="radio"/>
	14 kg	lateral	19200 lm	<input type="radio"/>

Non dimmable

Code
M168720
M168790
M168820
M168890

Dimmable

Code
M168721
M168791
M168821
M168891

Interactive Dali

Code
M168726
M168796
M168826
M168896

Presence detector

Code
M168729
M168799
M168829
M168899



IP20 ☉

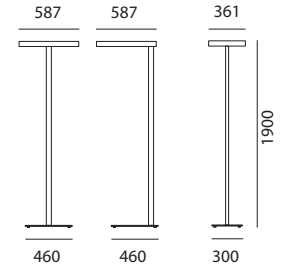

UGR<19
L<3000 cd/m² @65°

4x55 W /19200 lm

Efficiency 72% α=104°

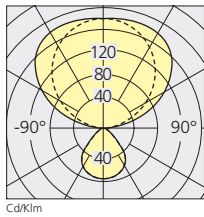

H m	Ø m	EMax lux	EM lux
1	2,55	1496	176
2	5,10	374	44
3	7,65	166	20
4	10,20	93	11
5	12,75	60	7

— C0 - C180
- - - C90 - C270

Components



Interactive-Dali
remote control

Code
M104900

Kalifa terra prismoptic II

TC-LEL (2G11) 4x55W.
Em (desk) 933lux.



Isolux

Calculation parameters to issue isolux diagrams:
Office with one work station.
Length x width x height 5,00x5,00x2,70m.
Reflectance factors ceiling/walls/floor: 70/50/20%.
Working plane 1,60x0,80x0,75m.
Maintenance factor 0,90WF.

1m 0m 1m 2m

Kalifa terra prismoptic III

White Grey

TC-LEL (2G11)

W	Weight	Stand	Flux	Color
2x80 W	13,5 kg	lateral	6000 lm	<input type="radio"/> <input checked="" type="radio"/>

Non dimmable

Code
M168920
M168990

Dimmable

Code
M168921
M168991

Interactive Dali

Color	Code
<input type="radio"/>	M168926
<input checked="" type="radio"/>	M168996



IP20 960°

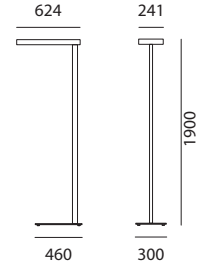

UGR<19
L<3000 cd/m² @65°

2x80 W /6000 lm Efficiency 70% α=104°

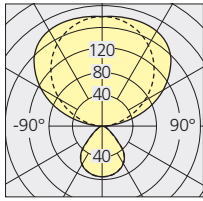

H _m	Ø _m	E _{Max} lux	E _M lux
1	2,55	836	99
2	5,10	209	25
3	7,65	93	11
4	10,20	52	6
5	12,75	33	4

Cd/Klm
— C0 - C180
- - - C90 - C270

Components



Interactive-Dali
remote control

Code
M104900

Kalifa terra prismoptic III
TC-LEL (2G11) 2x80W.
Em (desk) 542lux.

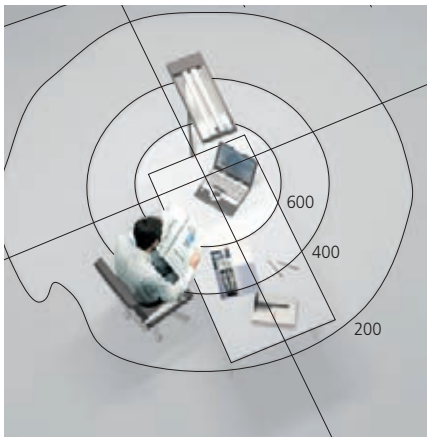

1m 0m 1m 2m

Isolux

Calculation parameters to issue isolux diagrams:
Office with one work station.
Length x width x height 5,00x5,00x2,70m.
Reflectance factors ceiling/walls/floor: 70/50/20%.
Working plane 1,60x0,80x0,75m.
Maintenance factor 0,90WF.



Kalifa II sospensione

Ernesto Gismondi
2009

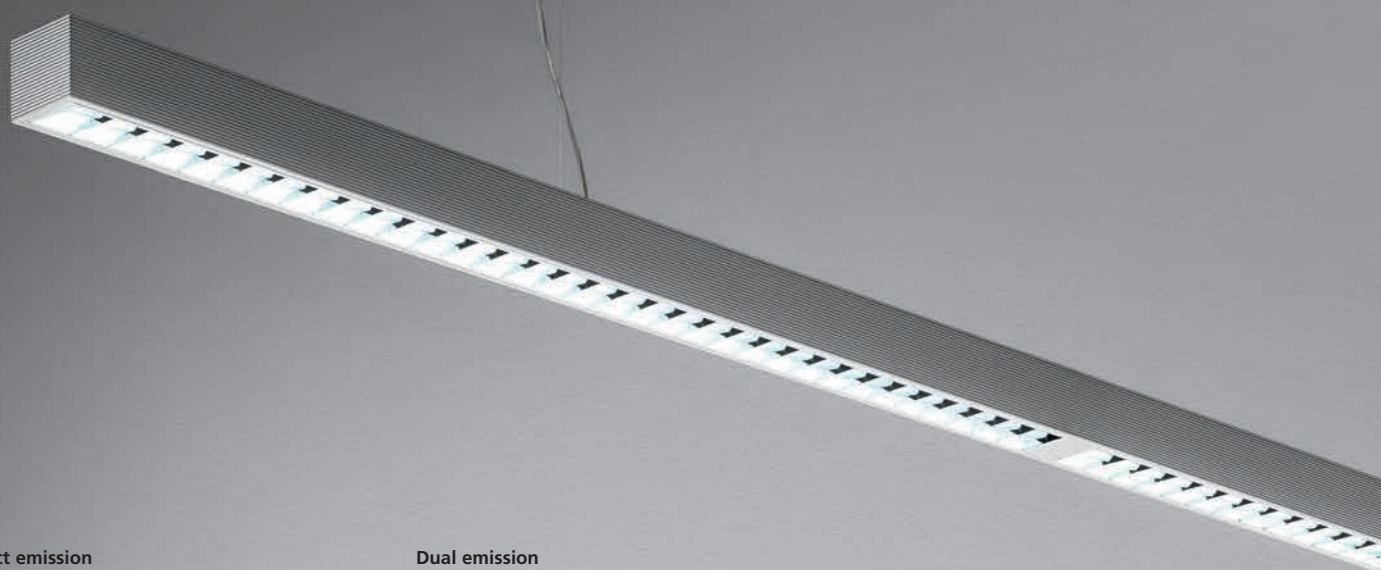

Direct emission

- Single pendant light with direct lighting using 28 W and 54 W T16 fluorescent light source.
- Extruded aluminium body with a white or grey paint finish, available in lengths of 1188mm (1xT16) and 2400mm (2xT16).
- Super pure aluminium dark light optics.
- Light output ratio: 82%.
- Dark light emission is in compliance with EN12464-1 standard, with average luminance levels lower than the 1000cd/m² limit for an observation angle of 65° or above with respect to the vertical axis.
- Electronic control gear, or Dali-SwitchDim dimmable electronic control gear. Emergency lighting on request.
- Quick adjustment steel suspension cables.
- Complies with standard EN60598-1 and other specific standards.

Dual emission

- Single pendant light with direct-indirect lighting using 28 W and 54 W T16 fluorescent light source.
- Extruded aluminium body with a white or grey paint finish, available in lengths of 1640mm and 2900mm.
- Super pure aluminium dark light optics.
- Light output ratio: 92%. light distribution: 30% indirect and 70% direct.
- Dark light emission is in compliance with EN12464-1 standard, with average luminance levels lower than the 1000cd/m² limit for an observation angle of 65° or above with respect to the vertical axis.
- Electronic control gear, or Dali-SwitchDim dimmable electronic control gear. Emergency lighting on request.
- Quick adjustment steel suspension cables.
- Complies with standard EN60598-1 and other specific standards.







Kalifa II sospensione direct emission

White Grey

Kalifa II - 1200

T16 (G5)

Non dimmable

Dali-SwitchDim

W	Flux	Length	Weight	Color	Code	Code
1x28 W	2600 lm	1200 mm	5,10 kg	○	M166720	M166721
				●	M166790	M166791
1x54 W	4450 lm	1200 mm	5,10 kg	○	M166920	M166921
				●	M166990	M166991

220/240Vac 50/60Hz electronic ballast included.

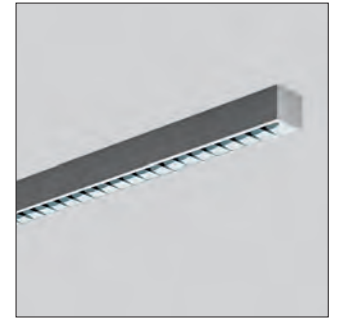

UGR<19
L<3000 cd/m² @65°

1x28 W /2600 lm

Efficiency 82% α=86°

1x54 W/4450 lm

Efficiency 82% α=86°

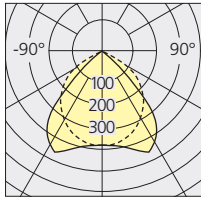

H m	Ø m	EMax lux	EM lux
1	1,86	967	226
2	3,72	242	57
3	5,58	107	25
4	7,43	60	14
5	9,29	39	9

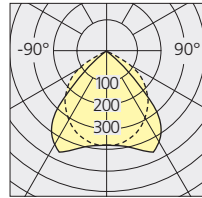

H m	Ø m	EMax lux	EM lux
1	1,86	1655	387
2	3,72	414	97
3	5,58	184	43
4	7,43	103	24
5	9,29	66	15

Cd/Klm
- - - C0 - C180
- - - C90 - C270

Cd/Klm
- - - C0 - C180
- - - C90 - C270

IP20

960°

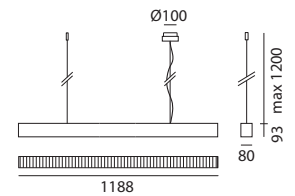

Kalifa II - 2400

T16 (G5)

Non dimmable

Dali-SwitchDim

W	Flux	Length	Weight	Color	Code	Code
2x28 W	5200 lm	2400 mm	8,90 kg	○	M166820	M167021
				●	M166890	M167091
2x54 W	8900 lm	2400 mm	8,90 kg	○	M167020	M167021
				●	M167090	M167091

220/240Vac 50/60Hz electronic ballast included.

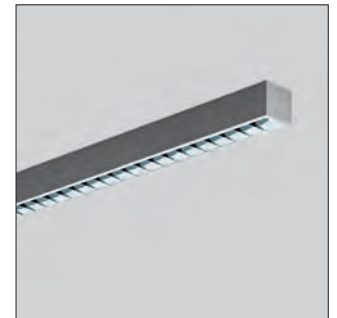

IP20

960°

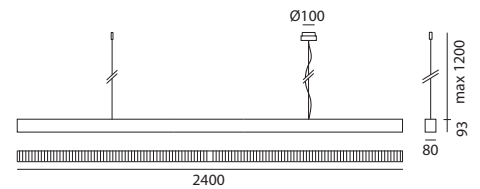

UGR<19
L<3000 cd/m² @65°

2x54 W/8900 lm

Efficiency 82% α=86°

2x28 W/5200 lm

Efficiency 82% α=86°

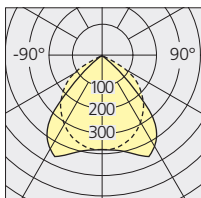

H m	Ø m	EMax lux	EM lux
1	1,86	3310	774
2	3,72	827	194
3	5,58	368	86
4	7,43	207	48
5	9,29	132	31

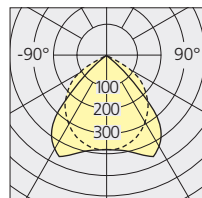

H m	Ø m	EMax lux	EM lux
1	1,86	1934	452
2	3,72	483	113
3	5,58	215	50
4	7,43	121	28
5	9,29	77	18

Cd/Klm
- - - C0 - C180
- - - C90 - C270

Cd/Klm
- - - C0 - C180
- - - C90 - C270

Kalifa II sospensione dual emission

White Grey

Kalifa II - 1640

T16 (G5)

Non dimmable

Dali-SwitchDim

W	Flux	Length	Weight	Color
2x24 W	3500 lm	1640 mm	4,80 kg	<input type="radio"/>
				<input checked="" type="radio"/>
2x14 W	2400 lm	1640 mm	4,80 kg	<input type="radio"/>
				<input checked="" type="radio"/>

Code
M167120
M167190

Code
M167121
M167191
M167121
M167191

220/240Vac 50/60Hz electronic ballast included.



IP20 960°

UGR<19
L<3000 cd/m² @65°

2x24 W/3500 lm Efficiency 92% α=86°

2x14 W/2400 lm Efficiency 92% α=86°

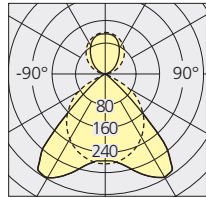

H m	Ø m	EMax lux	EM lux
1	1,88	928	248
2	3,76	232	62
3	5,63	103	28
4	7,51	58	16
5	9,39	37	10

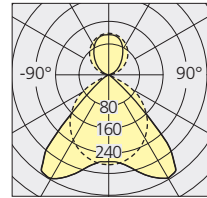

H m	Ø m	EMax lux	EM lux
1	1,88	635	170
2	3,76	159	43
3	5,63	71	19
4	7,51	40	11
5	9,39	25	7

--- C0 - C180
- - - C90 - C270

--- C0 - C180
- - - C90 - C270

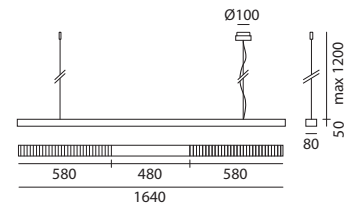

Kalifa II - 2900

T16 (G5)

Non dimmable

Dali-SwitchDim

W	Flux	Length	Weight	Color
2x54 W	8900 lm	2900 mm	8,40 kg	<input type="radio"/>
				<input checked="" type="radio"/>
2x28 W	5200 lm	2900 mm	8,40 kg	<input type="radio"/>
				<input checked="" type="radio"/>

Code
M167220
M167290

Code
M167221
M167291
M167221
M167291

220/240Vac 50/60Hz electronic ballast included.

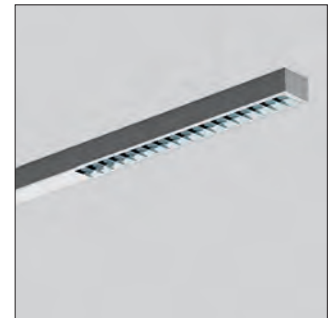

IP20 960°

UGR<19
L<3000 cd/m² @65°

2x54 W/8900 lm Efficiency 92% α=86°

2x28 W/5200 lm Efficiency 92% α=86°

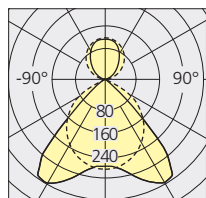

H m	Ø m	EMax lux	EM lux
1	1,88	2359	632
2	3,76	590	158
3	5,63	262	70
4	7,51	147	39
5	9,39	94	25

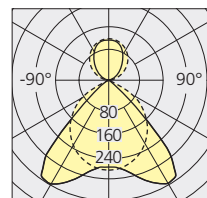

H m	Ø m	EMax lux	EM lux
1	1,86	1934	452
2	3,72	483	113
3	5,58	215	50
4	7,43	121	28
5	9,29	77	18

--- C0 - C180
- - - C90 - C270

--- C0 - C180
- - - C90 - C270

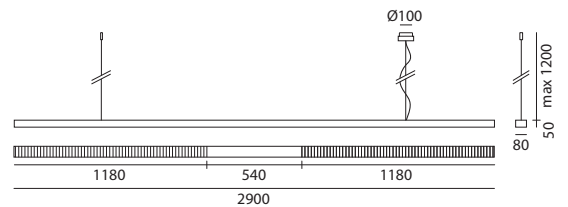

Kalifa II soffitto

Ernesto Gismondi
2009

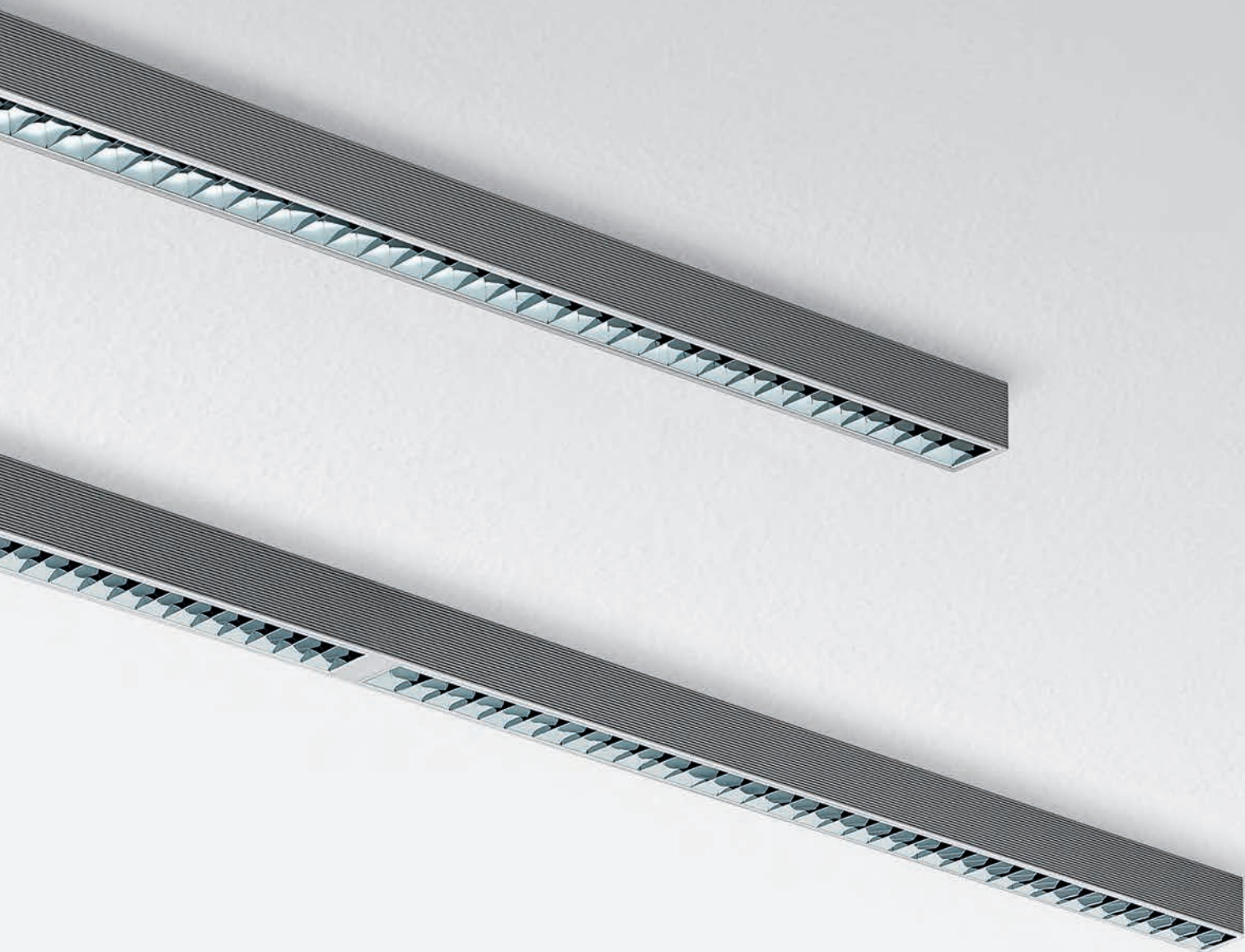

- Single ceiling light using 28 W and 54 W T16 fluorescent light source.
- Extruded aluminium body with a white or grey paint finish, available in lengths of 1188mm (1xT16) and 2400mm (2xT16).
- Super pure aluminium dark light optics.
- Light output ratio: 82%.
- Dark light emission is in compliance with EN12464-1 standard, with average luminance levels lower than the 1000cd/m² limit for an observation angle of 65° or above with respect to the vertical axis.
- Electronic control gear, or Dali-switchDim dimmable electronic control gear. Emergency lighting on request.
- Complies with standard EN60598-1 and other specific standards.

Kalifa II soffitto

White Grey

Kalifa II - 1200

T16 (G5)

Non dimmable

Dali-SwitchDim

W	Flux	Length	Weight	Color
1x28 W	2600 lm	1200 mm	5,10 kg	<input type="radio"/>
				<input checked="" type="radio"/>
1x54 W	4450 lm	1200 mm	5,10 kg	<input type="radio"/>
				<input checked="" type="radio"/>

Code
M181320
M181390
M181520
M181590

Code
M181321
M181391
M181521
M181591

220/240Vac 50/60Hz electronic ballast included.



IP20

960°

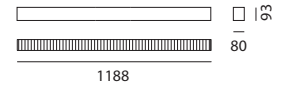

Kalifa II - 2400

T16 (G5)

Non dimmable

Dali-SwitchDim

W	Flux	Length	Weight	Color
2x54 W	8900 lm	2400 mm	8,90 kg	<input type="radio"/>
				<input checked="" type="radio"/>
2x28 W	5200 lm	2400 mm	8,90 kg	<input type="radio"/>
				<input checked="" type="radio"/>

Code
M181420
M181490
M181620
M181690

Code
M181621
M181691
M181621
M181691

220/240Vac 50/60Hz electronic ballast included.



IP20

960°

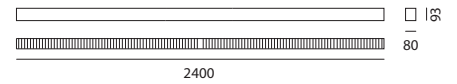

UGR<19 L<3000 cd/m² @65°

2x28 W/5200 lm

Efficiency 82%

α=86°

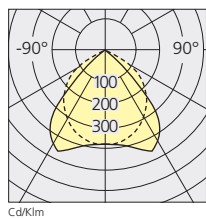

H m	Ø m	EMax lux	EM lux
1	1,86	1934	452
2	3,72	483	113
3	5,58	215	50
4	7,43	121	28
5	9,29	77	18

2x54 W/8900 lm

Efficiency 82%

α=86°

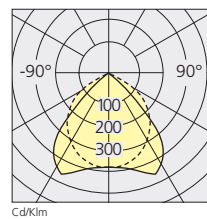

H m	Ø m	EMax lux	EM lux
1	1,86	3310	774
2	3,72	827	194
3	5,58	368	86
4	7,43	207	48
5	9,29	132	31

— C0 - C180
..... C90 - C270

— C0 - C180
..... C90 - C270

Kalifa parete

Ernesto Gismondi
2005



- A range of wall lamps with direct-indirect lighting using 1x24 W and 1x80 W T16, and 2x55w TC-LEL fluorescent lamps.
- Extruded aluminium body with white or grey paint finish, and 4mm thick screen-printed tempered glass.
- 3 size options: 100x587mm, 100x1487mm and 211x587mm.
- Light distribution: 82% indirect and 18% direct (TC-LEL version), 86% indirect and 14% direct (T16).
- Electronic control gear.
- Optional emergency lighting.
- Polycarbonate dust-protection screen.
- Complies with standard EN60598-1 and other specific standards.

Kalifa parete

White Grey

TC-LEL (2G11)

W	Weight	Flux	Color
2x55 W	3,20 kg	9600 lm	<input type="radio"/>
			<input checked="" type="radio"/>

Non dimmable

Code
M024320
M024390

+ emergency 1h

Code
M024327
M024397

220/240Vac 50/60Hz electronic ballast included.

TC-LEL

Efficiency 38%	2x55 W	9600 lm
----------------	--------	---------

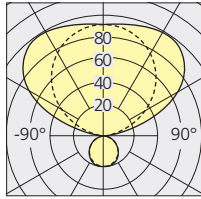

IP20 ⊕

850°

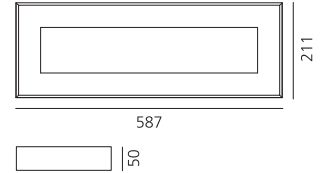

T16 (G5)

W	Length	Weight	Flux	Color
24 W	587 mm	1,90 kg	1750 lm	<input type="radio"/>
				<input checked="" type="radio"/>
80 W	1487 mm	3,70 kg	6150 lm	<input type="radio"/>
				<input checked="" type="radio"/>

Non dimmable

Code
M024120
M024190
M024220
M024290

T16 (G5)

Efficiency 30%	24 W	1750 lm
	80 W	6150 lm

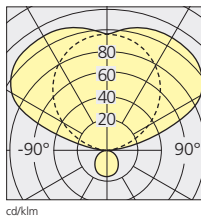

IP20 ⊕

850°

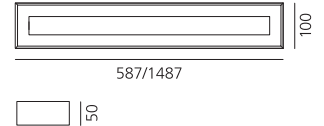



Innovatio spa, Kilometro Rosso Science & Technology Park, Bergamo (Italy),
Arch.: Giovanni Rizzi Architetto



Talo System

Neil Poulton
2007

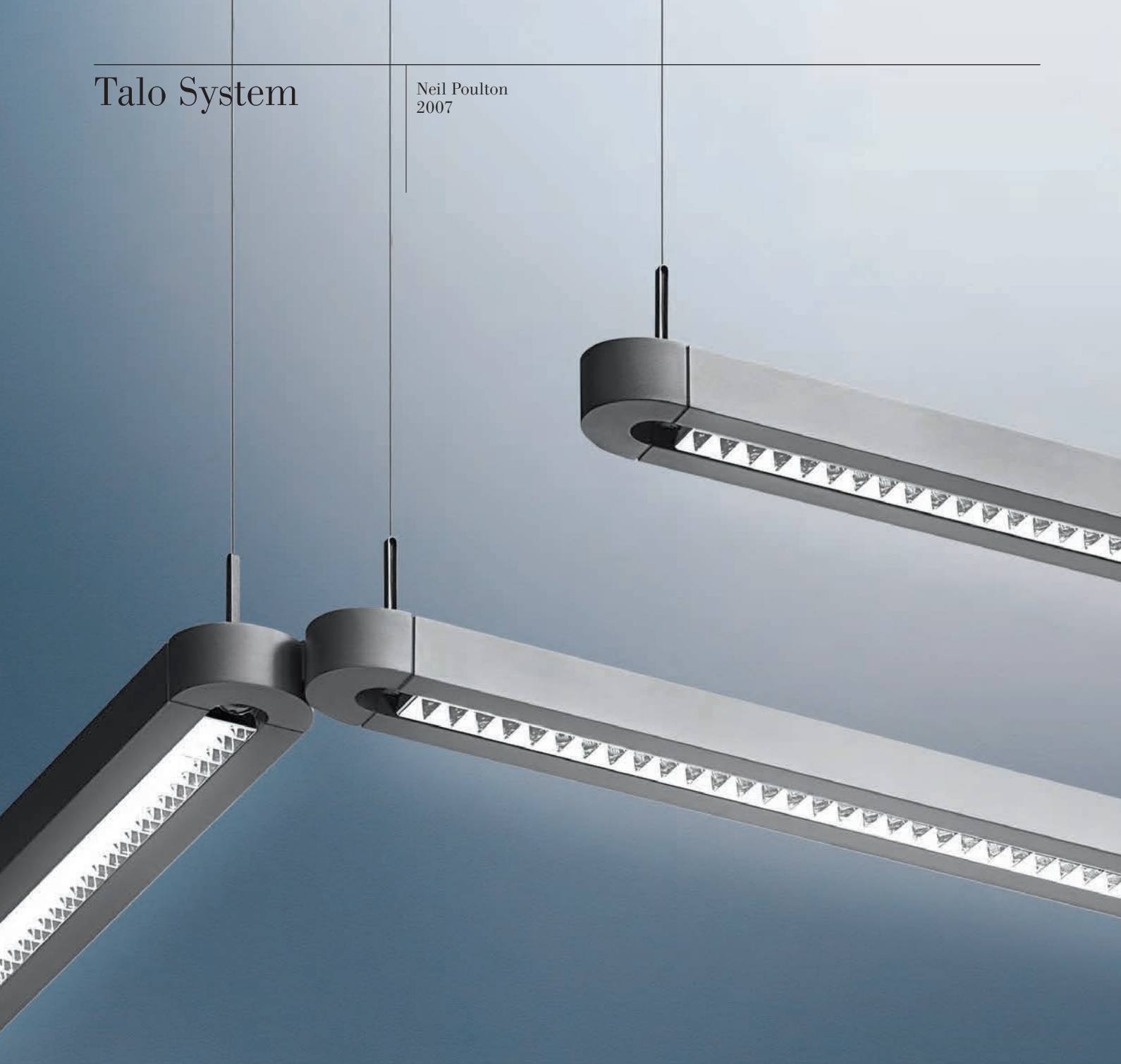



Talo System

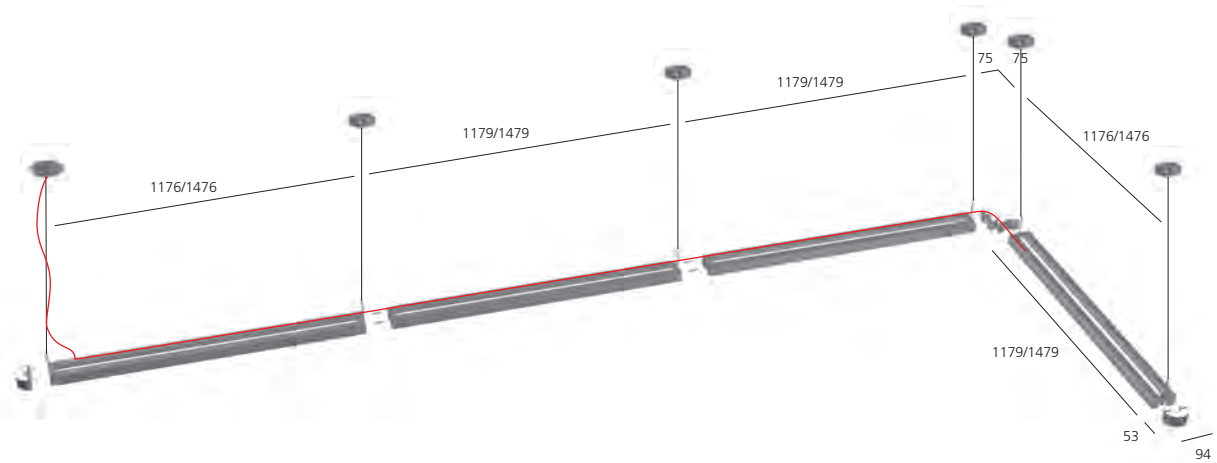

- Direct-indirect pendant system using 1x54 W, 1x80 W and 2x54 W T16 fluorescent lamps.
- Available as a single pendant light or as a modular system.
- Extruded aluminium body with a white or grey paint finish.
- End caps in die-cast aluminium.
- Dark light emission is in compliance with EN12464-1 standard, with average luminance levels lower than the 1000 cd/m² limit for an observation angle of 65° or above with respect to the vertical axis.
- Light output ratio: 62%.
- Light distribution: 50% indirect and 50% direct.
- Electronic ballast or dali-switchdim dimmable electronic ballast.
- The system comprises of power supply units with ceiling plate and power supply cable, and continuity modules.
- Intermodule mechanical connection by linear or 90° connectors.
- Electrical connection via quick connectors.
- Quick adjustment steel suspension cables.
- Complies with standard EN60598-1 and other specific standards.



Talo System suspension

○ White ● Grey

Talo System 1200 - 1500

T16 (G5)

Non dimmable

Dali-SwitchDim

W	Length	Weight	Flux	Color
1x54 W	1258 mm	4,20 kg	4450 lm	○
				●
1x80 W	1585 mm	4,80 kg	6150 lm	○
				●

Code
M135810
M135820
M135910
M135920

Code
M135811
M135821
M135911
M135921



IP20 ⊕

960°

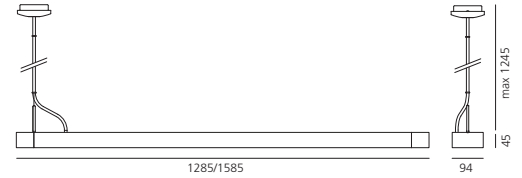

220/240Vac 50/60Hz electronic ballast included.

Talo System 2400

T16 (G5)

Non dimmable

Dali-SwitchDim

W	Length	Weight	Flux	Color
2x54 W	2486 mm	7,90 kg	8900 lm	○
				●
2x28 W	2486 mm	8,10 kg	5200 lm	○
				●

Code
M135310
M135320

Code
M135311
M135321
M135311
M135321



IP20 ⊕

960°

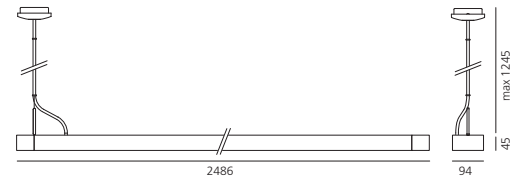

220/240Vac 50/60Hz electronic ballast included.

UGR<19

L<3000 cd/m² @65°

1x54 W /4450 lm

Efficiency 70% α=88°

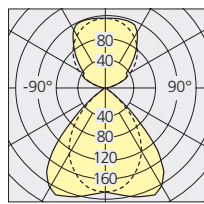

H m	Ø m	EMax lux	EM lux
1	1,95	781	162
2	3,90	195	41
3	5,86	87	18
4	7,81	49	10
5	9,76	31	6

— C0 - C180
- - - C90 - C270

1x80 W /6150 lm

Efficiency 70% α=86°

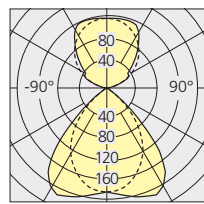

H m	Ø m	EMax lux	EM lux
1	1,89	1065	234
2	3,78	266	58
3	5,67	118	26
4	7,57	67	15
5	9,46	43	9

— C0 - C180
- - - C90 - C270

2x28W /5200 lm

Efficiency 70% α=88°

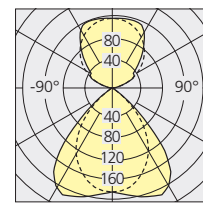

H m	Ø m	EMax lux	EM lux
1	1,95	1562	324
2	3,90	390	81
3	5,86	174	36
4	7,81	98	20
5	9,76	62	13

— C0 - C180
- - - C90 - C270

2x54 W /8900 lm

Efficiency 70% α=88°

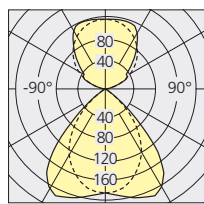

H m	Ø m	EMax lux	EM lux
1	1,95	1562	324
2	3,90	390	81
3	5,86	174	36
4	7,81	98	20
5	9,76	62	13

— C0 - C180
- - - C90 - C270

Talo System

○ White ● Grey

Talo System feeder module

T16 (G5)

W	Length	Weight	Flux	Color
1x54 W	1179 mm	4,00 kg	5200 lm	○
				●
1x80 W	1479 mm	4,60 kg	6150 lm	○
				●

220/240Vac 50/60Hz electronic ballast included.

Non dimmable

Code
M135410
M135420
M135610
M135620

Dali-SwitchDim

Code
M135411
M135421
M135611
M135621

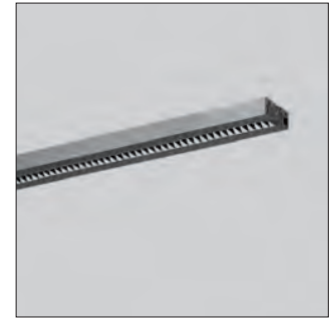

IP20

960°

Talo System continuity module

T16 (G5)

W	Length	Weight	Flux	Color
1x54 W	1179 mm	4,00 kg	5200 lm	○
				●
1x80 W	1479 mm	4,60 kg	6150 lm	○
				●

220/240Vac 50/60Hz electronic ballast included.

Non dimmable

Code
M135510
M135520
M135710
M135720

Dali-SwitchDim

Code
M135511
M135521
M135711
M135721

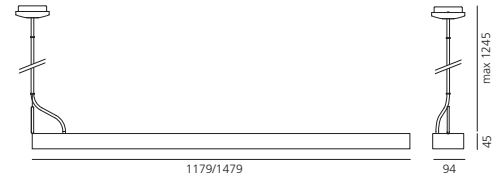

UGR<19
L<3000 cd/m² @65°

1x54 W /4450 lm

Efficiency 70% α=88°

1x80 W /6150 lm

Efficiency 70% α=86°

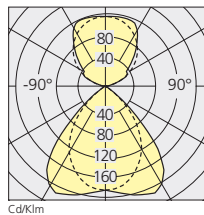

H m	Ø m	EMax lux	EM lux
1	1,95	781	162
2	3,90	195	41
3	5,86	87	18
4	7,81	49	10
5	9,76	31	6

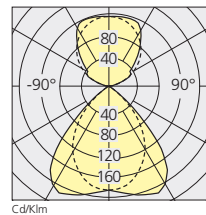



H m	Ø m	EMax lux	EM lux
1	1,89	1065	234
2	3,78	266	58
3	5,67	118	26
4	7,57	67	15
5	9,46	43	9

— C0 - C180
- - - C90 - C270

— C0 - C180
- - - C90 - C270

Components

	Color	code
 End caps (set of 2). 53x94x45 mm	○ ●	M136410 M136420
 90° connector. 120x120x45 mm	○ ●	M136510 M136520
 Steel suspension cable Ceiling plate ø100 mm 1400 mm	○ ●	M136610 M136620

Nota Bene System

2007

- Pendant system with direct-indirect lighting using 28 W and 54 W T16 fluorescent lamps.
- Available as a single pendant light or as a modular system.
- Steel body with a white or grey paint finish, available in lengths of 1234mm and 2416mm.
- Dark light optic made from super pure aluminium.
- Dark light emission is in compliance with EN12464-1 standard, with average luminance levels lower than the 1000 cd/m² limit for an observation angle of 65° or above with respect to the vertical axis.
- Light output ratio: 91% (1xT16) and 87% (2xT16).
- Light distribution: 65% indirect and 35% direct (1xT16), 63% indirect and 37% direct (2xT16).
- Electronic ballast or Dali-SwitchDim dimmable electronic ballast.
- The system consists of power supply units with ceiling plate and power supply cable, and continuity modules.
- Intermodule mechanical connection by linear or 90° connectors.
- Electrical connection via quick connectors.
- Quick adjustment steel suspension cables.
- Complies with standard EN60598-1 and other specific standards.











Nota Bene suspension

White  Grey 

Nota Bene 1200 darklight

T16 (G5)

W	Length	Weight	Flux	Color
1x28 W	1234 mm	4,10 kg	2600 lm	
				
2x28 W	1234 mm	4,20 kg	5200 lm	
				
1x54 W	1234 mm	4,10 kg	4450 lm	
				
2x54 W	1234 mm	4,20 kg	8900 lm	
				

Non dimmable

Code
M106620
M106690
M106720
M106790
M107020
M107090
M107120
M107190

Dali-SwitchDim

Code
M107121
M107191
M107121
M107191



220/240Vac 50/60Hz electronic ballast included.





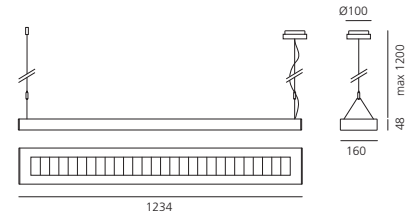



IP20 

850°



Nota Bene 2400 darklight

T16 (G5)

W	Length	Weight	Flux	Color
2x28 W	2416 mm	7,90 kg	5200 lm	
				
4x28 W	2416 mm	8,10 kg	10400 lm	
				
2x54 W	2416 mm	7,90 kg	8900 lm	
				
4x54 W	2416 mm	8,10 kg	17800 lm	
				

Non dimmable

Code
M106820
M106890
M106920
M106990
M107220
M107290
M107320
M107390

Dali-SwitchDim

Code
M107321
M107391
M107321
M107391



220/240Vac 50/60Hz electronic ballast included.

IP20 

850°

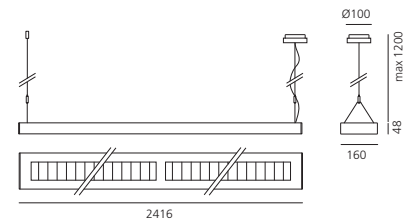

UGR<19

L<3000 cd/m² @65°

28W/2600lm

Efficiency 91% $\alpha=100^\circ$

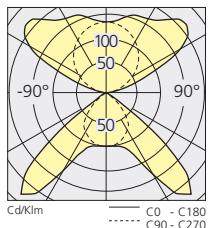

H m	Ø m	EMax lux	EM lux
1	2,41	264	86
2	4,82	66	21
3	7,23	29	10
4	9,64	16	5
5	12,05	11	3

54W/4450lm

Efficiency 91% $\alpha=100^\circ$

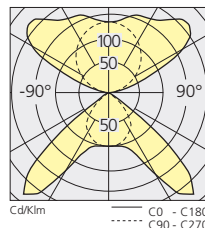

H m	Ø m	EMax lux	EM lux
1	2,41	252	146
2	4,82	113	37
3	7,23	50	16
4	9,64	28	9
5	12,05	18	6

2x28W/5200lm

Efficiency 87% $\alpha=106^\circ$

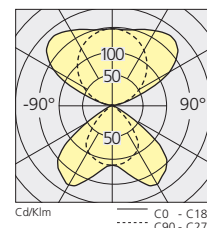

H m	Ø m	EMax lux	EM lux
1	2,64	588	98
2	5,29	147	25
3	7,93	65	11
4	10,58	37	6
5	13,22	24	4

2x54W/8900lm

Efficiency 87% $\alpha=106^\circ$

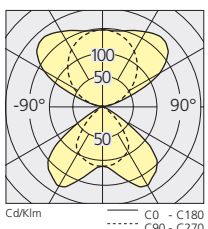

H m	Ø m	EMax lux	EM lux
1	2,64	1007	168
2	5,29	252	42
3	7,93	112	19
4	10,58	63	11
5	13,22	40	7

4x28W/10400lm

Efficiency 87% $\alpha=106^\circ$

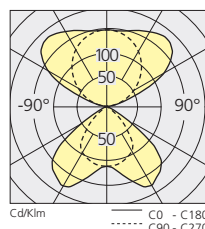

H m	Ø m	EMax lux	EM lux
1	2,64	1176	197
2	5,29	294	49
3	7,93	131	22
4	10,58	74	12
5	13,22	47	8

4x54W/17800lm

Efficiency 87% $\alpha=106^\circ$

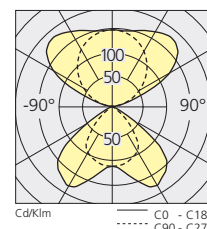

H m	Ø m	EMax lux	EM lux
1	2,64	2013	337
2	5,29	503	84
3	7,93	224	37
4	10,58	126	21
5	13,22	81	13



Nota Bene System

White
○
Grey
●

Power modules dark light

T16 (G5)				
W	Length	Weight	Flux	Color
1x28 W	1234 mm	3,90 kg	2600 lm	○
2x28 W	1234 mm	4,00 kg	5200 lm	○
1x54 W	1234 mm	3,90 kg	4450 lm	○
2x54 W	1234 mm	4,00 kg	8900 lm	○

Non dimmable	
Code	
M108420	○
M108490	●
M108520	○
M108590	●
M107520	○
M107590	●
M107620	○
M107690	●

Dali-SwitchDim	
Code	
M107621	○
M107691	●

+ emergency 1h	
Code	
M107627	○
M107697	●

220/240Vac 50/60Hz electronic ballast included.

Continuity modules dark light

T16 (G5)				
W	Length	Weight	Flux	Color
1x28 W	1234 mm	3,70 kg	2600 lm	○
2x28 W	1234 mm	3,80 kg	5200 lm	○
1x54 W	1234 mm	3,70 kg	4450 lm	○
2x54 W	1234 mm	3,80 kg	8900 lm	○

Non dimmable	
Code	
M108620	○
M108690	●
M108720	○
M108790	●
M107720	○
M107790	●
M107820	○
M107890	●

Dali-SwitchDim	
Code	
M107821	○
M107891	●

+ emergency 1h	
Code	
M107827	○
M107897	●

220/240Vac 50/60Hz electronic ballast included.

UGR<19 L<3000 cd/m² @65°

28W/2600lm	Efficiency 91% α=100°	54W/4450lm	Efficiency 91% α=100°	2x28W/5200lm	Efficiency 87% α=106°																																																																								
	<table border="1"> <thead> <tr> <th>H m</th> <th>Ø m</th> <th>EMax lux</th> <th>EM lux</th> </tr> </thead> <tbody> <tr><td>1</td><td>2,41</td><td>264</td><td>86</td></tr> <tr><td>2</td><td>4,82</td><td>66</td><td>21</td></tr> <tr><td>3</td><td>7,23</td><td>29</td><td>10</td></tr> <tr><td>4</td><td>9,64</td><td>16</td><td>5</td></tr> <tr><td>5</td><td>12,05</td><td>11</td><td>3</td></tr> </tbody> </table>	H m	Ø m	EMax lux	EM lux	1	2,41	264	86	2	4,82	66	21	3	7,23	29	10	4	9,64	16	5	5	12,05	11	3		<table border="1"> <thead> <tr> <th>H m</th> <th>Ø m</th> <th>EMax lux</th> <th>EM lux</th> </tr> </thead> <tbody> <tr><td>1</td><td>2,41</td><td>252</td><td>146</td></tr> <tr><td>2</td><td>4,82</td><td>113</td><td>37</td></tr> <tr><td>3</td><td>7,23</td><td>50</td><td>16</td></tr> <tr><td>4</td><td>9,64</td><td>28</td><td>9</td></tr> <tr><td>5</td><td>12,05</td><td>18</td><td>6</td></tr> </tbody> </table>	H m	Ø m	EMax lux	EM lux	1	2,41	252	146	2	4,82	113	37	3	7,23	50	16	4	9,64	28	9	5	12,05	18	6		<table border="1"> <thead> <tr> <th>H m</th> <th>Ø m</th> <th>EMax lux</th> <th>EM lux</th> </tr> </thead> <tbody> <tr><td>1</td><td>2,64</td><td>588</td><td>98</td></tr> <tr><td>2</td><td>5,29</td><td>147</td><td>25</td></tr> <tr><td>3</td><td>7,93</td><td>65</td><td>11</td></tr> <tr><td>4</td><td>10,58</td><td>37</td><td>6</td></tr> <tr><td>5</td><td>13,22</td><td>24</td><td>4</td></tr> </tbody> </table>	H m	Ø m	EMax lux	EM lux	1	2,64	588	98	2	5,29	147	25	3	7,93	65	11	4	10,58	37	6	5	13,22	24	4
H m	Ø m	EMax lux	EM lux																																																																										
1	2,41	264	86																																																																										
2	4,82	66	21																																																																										
3	7,23	29	10																																																																										
4	9,64	16	5																																																																										
5	12,05	11	3																																																																										
H m	Ø m	EMax lux	EM lux																																																																										
1	2,41	252	146																																																																										
2	4,82	113	37																																																																										
3	7,23	50	16																																																																										
4	9,64	28	9																																																																										
5	12,05	18	6																																																																										
H m	Ø m	EMax lux	EM lux																																																																										
1	2,64	588	98																																																																										
2	5,29	147	25																																																																										
3	7,93	65	11																																																																										
4	10,58	37	6																																																																										
5	13,22	24	4																																																																										
	<table border="1"> <thead> <tr> <th>H m</th> <th>Ø m</th> <th>EMax lux</th> <th>EM lux</th> </tr> </thead> <tbody> <tr><td>1</td><td>2,64</td><td>1007</td><td>168</td></tr> <tr><td>2</td><td>5,29</td><td>252</td><td>42</td></tr> <tr><td>3</td><td>7,93</td><td>112</td><td>19</td></tr> <tr><td>4</td><td>10,58</td><td>63</td><td>11</td></tr> <tr><td>5</td><td>13,22</td><td>40</td><td>7</td></tr> </tbody> </table>	H m	Ø m	EMax lux	EM lux	1	2,64	1007	168	2	5,29	252	42	3	7,93	112	19	4	10,58	63	11	5	13,22	40	7		<table border="1"> <thead> <tr> <th>H m</th> <th>Ø m</th> <th>EMax lux</th> <th>EM lux</th> </tr> </thead> <tbody> <tr><td>1</td><td>2,64</td><td>1176</td><td>197</td></tr> <tr><td>2</td><td>5,29</td><td>294</td><td>49</td></tr> <tr><td>3</td><td>7,93</td><td>131</td><td>22</td></tr> <tr><td>4</td><td>10,58</td><td>74</td><td>12</td></tr> <tr><td>5</td><td>13,22</td><td>47</td><td>8</td></tr> </tbody> </table>	H m	Ø m	EMax lux	EM lux	1	2,64	1176	197	2	5,29	294	49	3	7,93	131	22	4	10,58	74	12	5	13,22	47	8		<table border="1"> <thead> <tr> <th>H m</th> <th>Ø m</th> <th>EMax lux</th> <th>EM lux</th> </tr> </thead> <tbody> <tr><td>1</td><td>2,64</td><td>2013</td><td>337</td></tr> <tr><td>2</td><td>5,29</td><td>503</td><td>84</td></tr> <tr><td>3</td><td>7,93</td><td>224</td><td>37</td></tr> <tr><td>4</td><td>10,58</td><td>126</td><td>21</td></tr> <tr><td>5</td><td>13,22</td><td>81</td><td>13</td></tr> </tbody> </table>	H m	Ø m	EMax lux	EM lux	1	2,64	2013	337	2	5,29	503	84	3	7,93	224	37	4	10,58	126	21	5	13,22	81	13
H m	Ø m	EMax lux	EM lux																																																																										
1	2,64	1007	168																																																																										
2	5,29	252	42																																																																										
3	7,93	112	19																																																																										
4	10,58	63	11																																																																										
5	13,22	40	7																																																																										
H m	Ø m	EMax lux	EM lux																																																																										
1	2,64	1176	197																																																																										
2	5,29	294	49																																																																										
3	7,93	131	22																																																																										
4	10,58	74	12																																																																										
5	13,22	47	8																																																																										
H m	Ø m	EMax lux	EM lux																																																																										
1	2,64	2013	337																																																																										
2	5,29	503	84																																																																										
3	7,93	224	37																																																																										
4	10,58	126	21																																																																										
5	13,22	81	13																																																																										





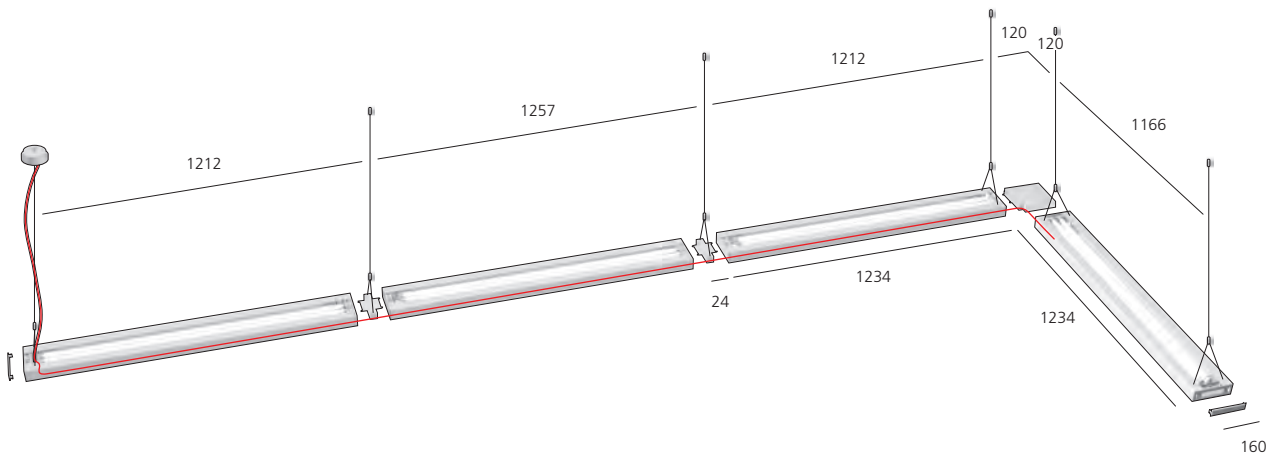
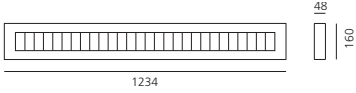

IP20

850°



Components

	Color	code
 Decorative end cover (set of 2) 200x50x3mm	●	M108020
 L-shaped connector 160x160x27mm	○ ●	M108220 M108290
 Linear connector 23x139x27mm	○ ●	M108120 M108190
 Steel suspension cable Ceiling plate \varnothing 100mm l. 1200mm		M108320

Nota Bene ceiling

2007



- Single ceiling lights using 1x54 W or 2x54 W T16 fluorescent light source.
- Two lighting options: dark light and wall washer.
- Steel body with a white or grey paint finish.
- Electronic control gear, with or without dimming (Dali-SwitchDim).
- Lamps can be maintained without removing the luminaire.
- Complies with standard EN60598-1 and other specific standards.

Nota Bene ceiling dark light

- Super pure aluminum dark light optics.
- Dark light emission is in compliance with EN12464-1 standard, with average luminance levels lower than the 1000cd/m² limit for an observation angle of 65° or above with respect to the vertical axis.
- Light output ratio 71%.
- Emergency lighting as an optional extra.

Nota Bene ceiling wall washer

- Asymmetric aluminum reflector.



Nota Bene ceiling

White Grey

Nota Bene 1200 darklight

T16 (G5)

W	Length	Weight	Flux	Color
1x54 W	1234 mm	4,20 kg	4450 lm	<input type="radio"/>
				<input checked="" type="radio"/>

Non dimmable

Code
M109020
M109090

Dali-SwitchDim

Code
M109021
M109091

+ emergency 1h

Color	Code
<input type="radio"/>	M109027
<input checked="" type="radio"/>	M109097



220/240Vac 50/60Hz electronic ballast included.

IP20 850°

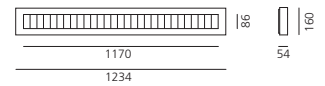

Nota Bene 2400 darklight

T16 (G5)

W	Length	Weight	Flux	Color
2x54 W	2480 mm	7,90 kg	8900 lm	<input type="radio"/>
				<input checked="" type="radio"/>
2x28 W	2480 mm	8,10 kg	5200 lm	<input type="radio"/>
				<input checked="" type="radio"/>

Non dimmable

Code
M109120
M109190

Dali-SwitchDim

Code
M109121
M109191
M109121
M109191



220/240Vac 50/60Hz electronic ballast included.

IP20 850°

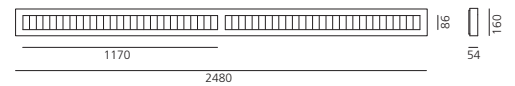

UGR<19 L<3000 cd/m² @65°

54W/4450lm

Efficiency 72% $\alpha=88^\circ$

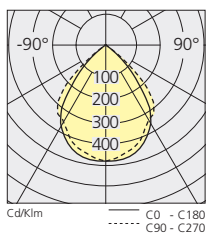

2x28W/5200lm

Efficiency 72% $\alpha=88^\circ$

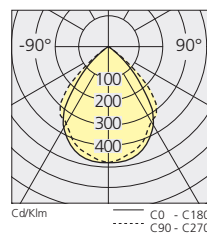

2x54W/4450lm

Efficiency 72% $\alpha=88^\circ$

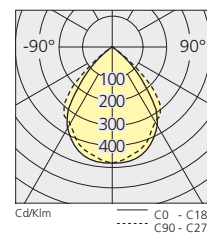

Nota Bene ceiling

White Grey

Nota Bene 1200 Wall Washer T16 (G5)

W	Length	Weight	Flux	Color
1x54 W	1234 mm	4,20 kg	4450 lm	<input type="radio"/>
				<input checked="" type="radio"/>

Non dimmable

Dali-SwitchDim

Code
M109220
M109290

Code
M109221
M109291



220/240Vac 50/60Hz electronic ballast included.

IP20

850°

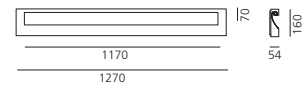

Nota Bene 2400 Wall Washer T16 (G5)

W	Length	Weight	Flux	Color
2x54 W	2480 mm	7,90 kg	8900 lm	<input type="radio"/>
				<input checked="" type="radio"/>
2x28 W	2480 mm	8,10 kg	5200 lm	<input type="radio"/>
				<input checked="" type="radio"/>

Non dimmable

Dali-SwitchDim

Code
M109320
M109390

Code
M109321
M109391
M109321
M109391



220/240Vac 50/60Hz electronic ballast included.

IP20

850°

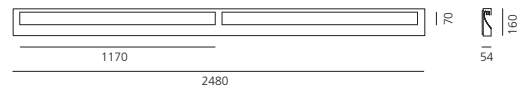

T16

Efficiency 62%

1x54 W	4450 lm
2x28 W	5200 lm
2x54 W	8900 lm

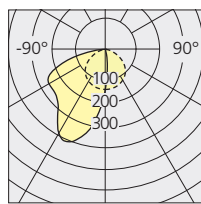

cd/klm

T16 (G5) 54W.
Em (wall) 500lux.

Isolux

Calculation parameters to issue isolux curve diagrams 54W (n luminaires in continuous line):
Length x height 10,00x3,00m.
Reflectance factors ceiling/walls/floor 70/50/20%.
Distance from wall to illuminate 1,00m.
Distance from side wall 1,00m.
Maintenance factor 0,90WF.

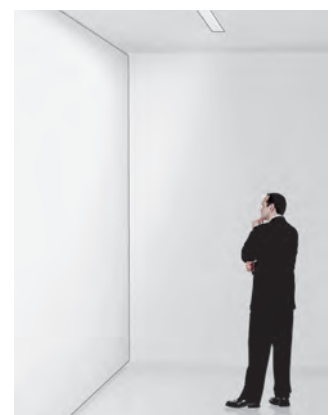

D=H/3



General Lighting	520	Tagora
	554	Ourea 156
	560	Mouette
	568	Twist
	572	Absolu
	576	Kao
	584	Tray
	586	Solar LED
	594	Bolero
	596	Kalifa Recessed
	600	Leb
	604	Starled
	608	Pixel Mesh



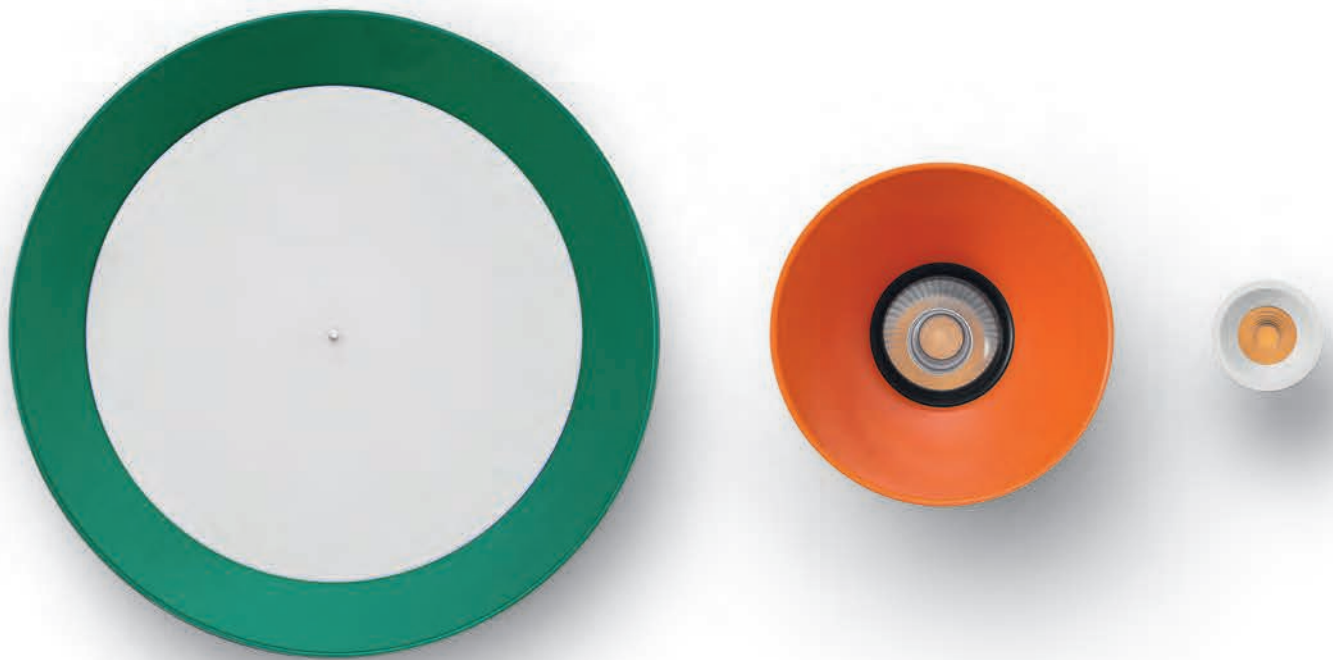

A series of cylindrical luminaires for ceiling-mounted installation, available with different diameters and depths, allowing cluster configurations. Tagora is a versatile family of products, ideal for a wide range of applications. A choice between high performance LED, fluorescent, halogen and metal halide, plus spot or diffused options, gives the Tagora family great flexibility.

Tagora recessed



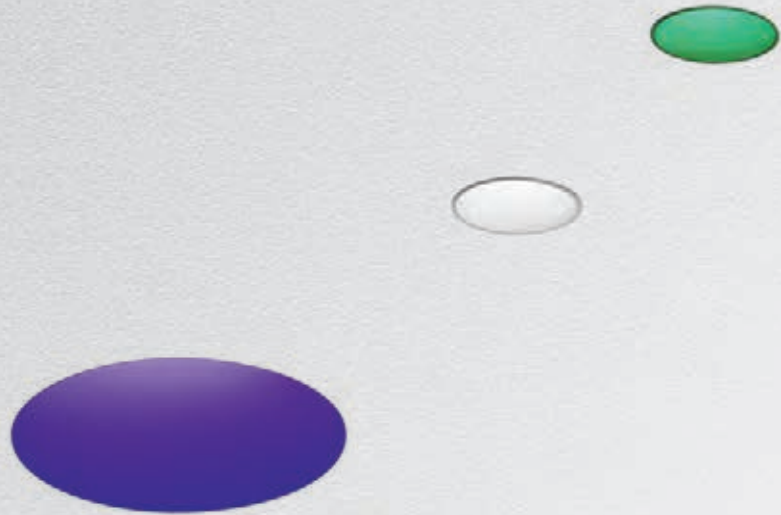

- Series of ceiling mounted luminaires available in 4 diameters (80 mm, 270 mm, 570 mm, 970 mm), using high-output LEDs, Retrofit LEDs, 12V halogen lamps, metal halide and fluorescent sources.
- Consists of a trimless recessed frame fitted into the ceiling and an optical unit with an aluminium body painted in a range of colours.
- Tagora 80 and 270 offer high-output spot light with aluminium optics. 2 beam angles for LED version and 3 for HIT version.
- Tagora 270 LED uses a proprietary system based on a hybrid combined lens and reflector optic. This system helps to create defined narrow beams using high-powered LED modules of large dimensions.

- Tagora 570 and 970 cone with a PMMA diffuser, offering a comfortable diffused light. LED versions use high-output sources.
- Monochromatic LED option with warm white (3000 K) and neutral white (4000 K) tones.
- Integrated electronic power supply, dimmable or non-dimmable options, depending on the version.
- Emergency lighting available on Tagora 570 fluorescent option.
- Only ceiling recessed installation allowed.
- Compliant with standard EN60598-1 and other specific standards.

Tagora recessed 80 LED

Orange White Green Blue

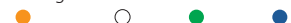

LED

W	Weight	Beam	Flux	CCT	Color	Code
14 W	0,35 kg	20°	655 lm	3000 K	Orange	M249010
					White	M249020
					Green	M249040
			Blue	M249030		
			Orange	M249110		
			White	M249120		
		735 lm	4000 K	Green	M249140	
				Blue	M249130	
				Orange	M249410	
			White	M249420		
			Green	M249440		
			Blue	M249430		
45°	680 lm	3000 K	Orange	M249410		
			White	M249420		
			Green	M249440		
	765 lm	4000 K	Blue	M249430		
			Orange	M249510		
			White	M249520		
Green	M249540					
Blue	M249530					



IP20
(LED GU10)
960°

Ø92

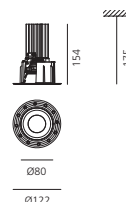

Electronic ballast 350 mA SELV supplied separately.

Driver	Va	Lmm	Wmm	Hmm	n°device	Code
cc 16W 500mA	220-240	156	52	26	1 max	DAI dimmable M077401

LED (GU10)

Weight	Color	Code
220 V 0,35 kg	Orange	M020210
240 V*	White	M020220
	Green	M020240
	Blue	M020230

*Max 81mm (overall)

Tagora 80 LED 20°

LED	luminaire				14 W	3000 K				α=20°				4000 K				α=20°			
Power	10 W	10 W	14 W	14 W		H	Ø	EMax	EM	H	Ø	EMax	EM	H	Ø	EMax	EM				
Flux	940 lm	1055 lm	655 lm	735 lm		m	m	lux	lux	m	m	lux	lux	m	m	lux	lux				
CCT	3000 K	4000 K	3000 K	4000 K		1	0,36	3238	2099	1	0,36	3633	2355	1	0,36	3633	2355				
CRI	=80 (typ.)					2	0,71	809	525	2	0,71	908	589	2	0,71	908	589				
Color tolerance	MacAdam 3SDCM					3	1,07	360	233	3	1,07	404	262	3	1,07	404	262				
Service life	L70(6K) > 50000h				4	1,42	202	131	4	1,42	227	147	4	1,42	227	147					
Beam	20°				5	1,78	130	84	5	1,78	145	94	5	1,78	145	94					
Efficiency	70 %				cd/klm																
Efficacy	92 lm/W	103 lm/W	64 lm/W	72 lm/W																	

Tagora 80 LED 45°

LED	luminaire				14 W	3000 K				α=45°				4000 K				α=45°			
Power	10 W	10 W	14 W	14 W		H	Ø	EMax	EM	H	Ø	EMax	EM	H	Ø	EMax	EM				
Flux	940 lm	1055 lm	680 lm	765 lm		m	m	lux	lux	m	m	lux	lux	m	m	lux	lux				
CCT	3000 K	4000 K	3000 K	4000 K		1	0,82	1370	821	1	0,82	1541	924	1	0,82	1541	924				
CRI	=80 (typ.)					2	1,65	343	205	2	1,65	385	231	2	1,65	385	231				
Color tolerance	MacAdam 3SDCM					3	2,47	152	91	3	2,47	171	103	3	2,47	171	103				
Service life	L70(6K) > 50000h				4	3,29	86	51	4	3,29	96	58	4	3,29	96	58					
Beam	45°				5	4,12	55	33	5	4,12	62	37	5	4,12	62	37					
Efficiency	72 %				cd/klm																
Efficacy	92 lm/W	103 lm/W	66,5 lm/W	74 lm/W																	

Tagora recessed 80 HIT/HALO

Orange ● White ○ Green ● Blue ●

QR-CBC51 (GU5,3)

W	Weight	Color	Code
12 V	0,35 kg	●	M020810
max 35 W		○	M020820
		●	M020840
		●	M020830

retrofit ▶ MASTER LEDspot MR16 (GU5,3) 12V 7 W

220/240Vac 50/60Hz electronic ballast included.

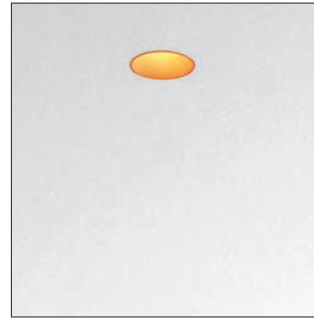

IP20
960°

∅92

HIPAR51-CE-P (GX10)

W	Weight	Color	Code
20 W	1,20 kg	●	M020710
		○	M020720
		●	M020740
		●	M020730

220/240Vac 50/60Hz electronic ballast included.

QR-CBC51 HIT (GU6,5)
HIPAR51

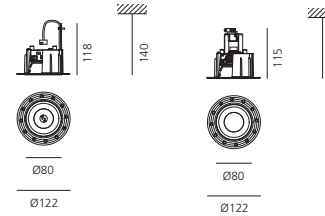

HIT-TC-CE (GU6,5)

W	Weight	Beam	Flux	Color	Code
20 W	1,20 kg	12°	1700 lm	●	M020910SP
				○	M020920SP
				●	M020940SP
				●	M020930SP
		26°	1700 lm	●	M020910MFL
				○	M020920MFL
				●	M020940MFL
				●	M020930MFL
		59°	1700 lm	●	M020910FL
				○	M020920FL
				●	M020940FL
				●	M020930FL

220/240Vac 50/60Hz electronic ballast included.

Driver	10-35 W	230-240V/12V	dimmable	M070211
Power supply for HIT	20 W	230-240V		M071232

20 W/1700 lm

Efficiency 42% α=12°

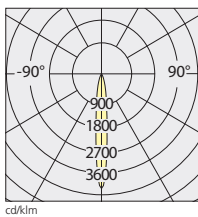

H m	∅ m	EMax lux	EM lux
1	0,20	6959	4401
2	0,39	1740	1100
3	0,59	773	489
4	0,79	435	275
5	0,98	278	176

20 W/1700 lm

Efficiency 42% α=26°

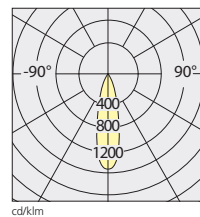

H m	∅ m	EMax lux	EM lux
1	0,47	2568	1619
2	0,93	642	405
3	1,40	285	180
4	1,87	160	101
5	2,34	103	65

20 W/1700 lm

Efficiency 82% α=59°

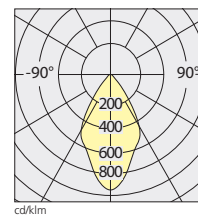

H m	∅ m	EMax lux	EM lux
1	1,13	1563	748
2	2,25	391	187
3	3,38	174	83
4	4,50	98	47
5	5,63	63	30

Tagora recessed 270 LED

Orange White Green Blue



LED

W	Weight	Beam	Flux	CCT	Color
31 W	2,60 kg	16°	1400 lm	3000 K	Orange
					White
					Green
			1480 lm	4000 K	Orange
					White
					Green
		32°	1310 lm	3000 K	Orange
					White
					Green
			1386 lm	4000 K	Orange
					White
					Green

Dali-SwitchDim

Code
M250411
M250421
M250441
M250431
M250511
M250521
M250541
M250531
M250611
M250621
M250641
M250631
M250711
M250721
M250741
M250731



IP20
750°

Ø292

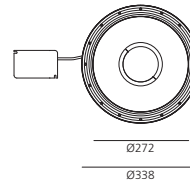
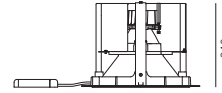

220/240Vac 50/60Hz electronic ballast included. Dimmable Dali-SwitchDim. Supply voltage 220-240V. Insulation class II. SELV. IP20.

Tagora 270 LED 16°

LED	luminaire	
26 W	26 W	31 W 31 W
2950 lm	3110 lm	1400 lm 1480 lm
3000 K	4000 K	3000 K 4000 K
CRI =80 (min.)		
Color tolerance MacAdam 3SDCM		
Service life L70(6K) > 50000h		
Beam		16° 16°
Efficiency		48% 48%
Efficacy	113 lm/W 118 lm/W	45 lm/W 48 lm/W

31 W

3000 K α=16° 4000 K α=16°

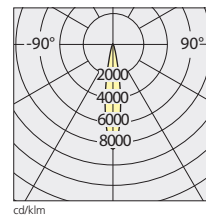

H m	Ø m	EMax lux	EM lux	H m	Ø m	EMax lux	EM lux
1	0,29	12125	7697	1	0,29	12817	8137
2	0,57	3031	1924	2	0,57	3204	2034
3	0,86	1347	855	3	0,86	1424	904
4	1,14	758	481	4	1,14	801	509
5	1,43	485	308	5	1,43	513	325

Tagora 270 LED 32°

LED	luminaire	
26 W	26 W	31 W 31 W
2950 lm	3110 lm	1310 lm 1386 lm
3000 K	4000 K	3000 K 4000 K
CRI =80 (min.)		
Color tolerance MacAdam 3SDCM		
Service life L70(6K) > 50000h		
Beam		32° 32°
Efficiency		44% 44%
Efficacy	113 lm/W 118 lm/W	42 lm/W 48 lm/W

31 W

3000 K α=32° 4000 K α=32°

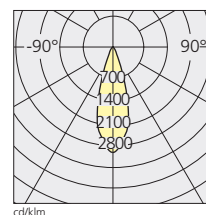

H m	Ø m	EMax lux	EM lux	H m	Ø m	EMax lux	EM lux
1	0,56	4043	2491	1	0,56	4278	2636
2	1,13	1011	623	2	1,13	1069	659
3	1,69	449	277	3	1,69	475	293
4	2,26	253	156	4	2,26	267	165
5	2,82	162	100	5	2,82	171	105



Tagora recessed 270 HIT/Fluo

Orange ● White ○ Green ● Blue ●

HIT-CE (G12)

W	Weight	Beam	Flux	Color	Code
70 W	2,64 kg	42°	6300 lm	●	M021210
				○	M021220
				●	M021240
				●	M021230
				●	M021310
		66°	6600 lm	●	M021320
				●	M021340
				●	M021330
				●	M021340
				●	M021330

220/240Vac 50/60Hz electronic ballast included.



70 W/6300 lm Efficiency 61% α=42°

70 W/6600 lm Efficiency 71% α=66°

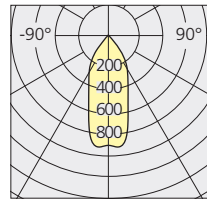

H m	Ø m	EMax lux	EM lux
1	0,75	5863	3527
2	1,50	1466	882
3	2,25	651	392
4	2,99	366	220
5	3,74	235	141

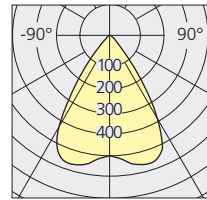

H m	Ø m	EMax lux	EM lux
1	1,35	2553	1294
2	2,70	638	324
3	4,05	284	144
4	5,40	160	81
5	6,75	102	52

IP20
750°

Ø292

TC-TEL / TC-DEL

HIT

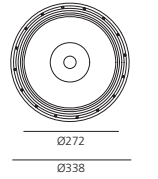
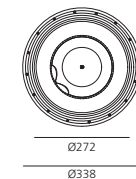
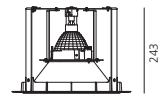
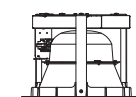

TC-DEL (G24q-3)

non dimmable

Dali-SwitchDim

W	Weight	Beam	Flux	Color	Code
2x26 W	2,38 kg	70°	3600 lm	●	M021110
				○	M021120
				●	M021140
				●	M021130
				●	M021130

220/240Vac 50/60Hz electronic ballast included.

2x26 W/3600 lm Efficiency 46% 70°

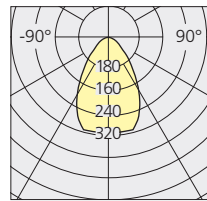

H m	Ø m	EMax lux	EM lux
1	1,37	1091	307
2	2,75	273	77
3	4,12	121	34
4	5,50	68	19
5	6,87	44	12

TC-TEL (GR14q-1)

non dimmable

Dali-SwitchDim

W	Weight	Beam	Flux	Color	Code
2x17 W	2,38 kg	66°	3000 lm	●	M021010
				○	M021020
				●	M021040
				●	M021030
				●	M021030

2x17 W/3000 lm Efficiency 40% 66°

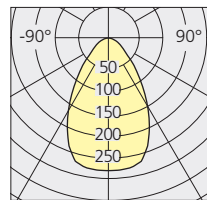

H m	Ø m	EMax lux	EM lux
1	1,31	702	206
2	2,62	176	52
3	3,93	78	23
4	5,24	44	13
5	6,54	28	8

Power supply for HIT 70 W 230-240V M070522

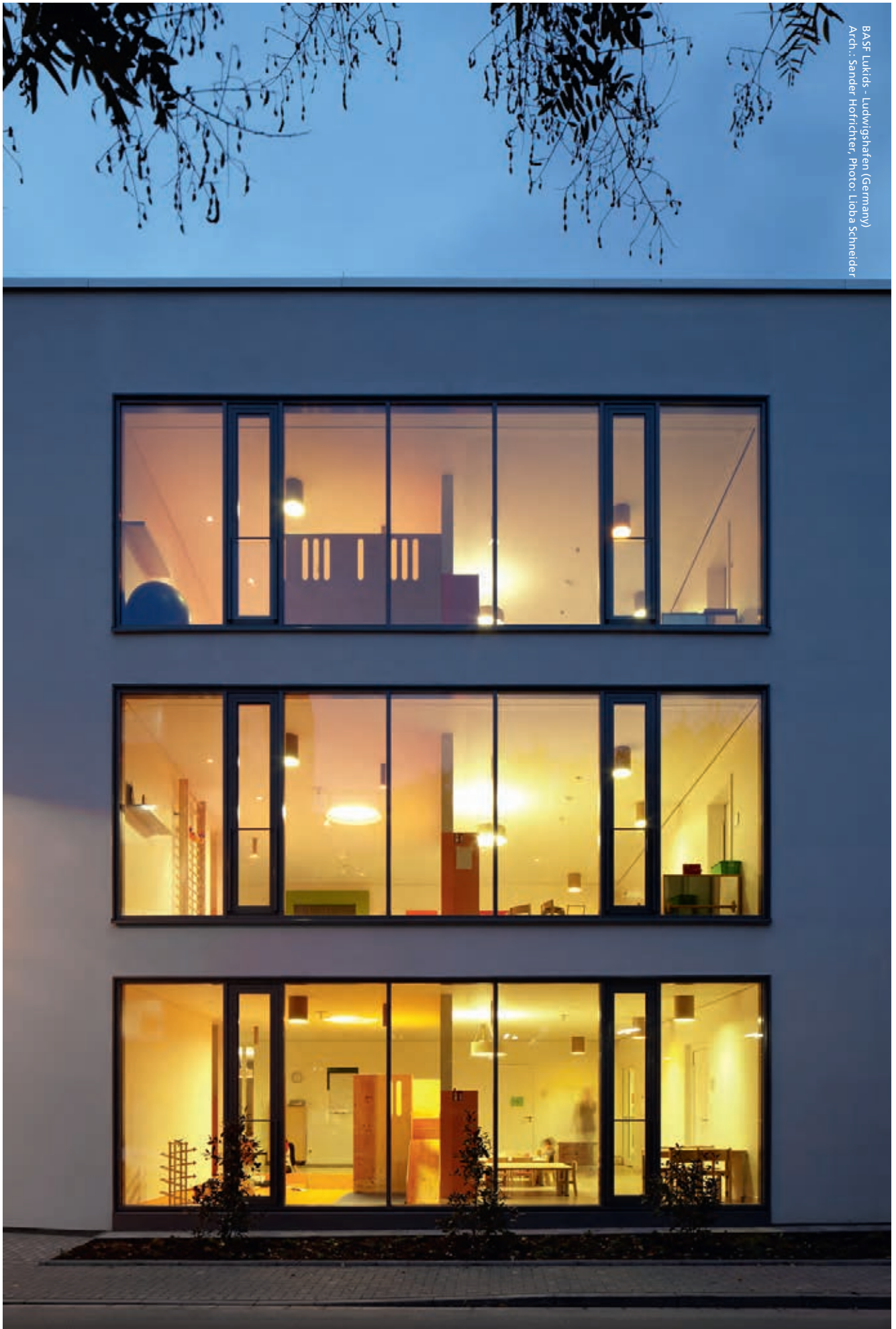

Tagora recessed 570

Orange White Green Blue



IP40 650° ∅606

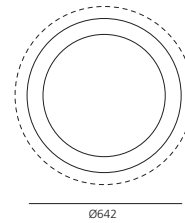
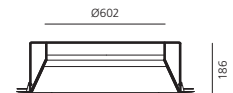

LED						Dali-SwitchDim	
W	Weight	Beam	Flux	CCT	Color	Code	
46 W	5,90 kg	102°	2175 lm	3000 K	●	M250211	
					○	M250221	
					●	M250241	
					●	M250231	
			2316 lm	4000 K	●	M250311	
					○	M250321	
					●	M250341	
					●	M250331	

220/240Vac 50/60Hz electronic ballast included. Dimmable Dali-SwitchDim. Supply voltage 220-240V. Insulation class II. SELV. IP20.

Tagora 570 LED	LED				luminaire				46 W	3000 K	α=102°	4000 K	α=102°				
	Power	Flux	CCT	CRI	Color tolerance	Service life	Beam	Efficiency						Efficacy	H _m	∅ _m	EMax _{lux}
Power	40 W	40 W	46 W	46 W													
Flux	4840 lm	5200 lm	2175 lm	2316 lm													
CCT	3000 K	4000 K	3000 K	4000 K													
CRI	=80 (typ.)																
Color tolerance	MacAdam 4SDCM																
Service life	L70(6K) > 36000h																
Beam			102°	102°													
Efficiency			45%	45%													
Efficacy	121 lm/W	130 lm/W	47 lm/W	50 lm/W													

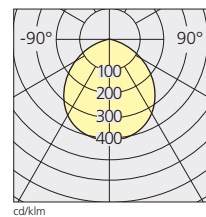

TC-LEL (2G11)					non dimmable		+ emergency 1h		Dali-SwitchDim	
W	Weight	Beam	Flux	Color	Code	Code	Code	Code	Code	Code
4x36 W	5,85 kg	106°	11600 lm	●	M016010	M016017	M016011			
				○	M016020	M016027	M016021			
				●	M016040	M016047	M016041			
				●	M016030	M016037	M016031			

220/240Vac 50/60Hz electronic ballast included.

4x36 W/11600 lm Efficiency 30% 106°

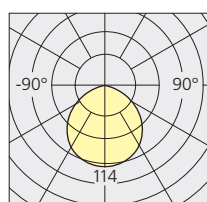

H _m	∅ _m	EMax _{lux}	EM _{lux}
1	2,58	1364	157
2	5,16	341	39
3	7,74	152	17
4	10,31	85	10
5	12,89	55	6

Tagora recessed 970

Orange White Green Blue



IP40 650° \varnothing 1002

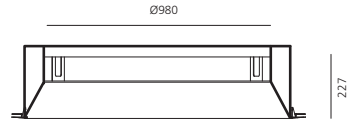

LED						Dali-SwitchDim	
W	Weight	Beam	Flux	CCT	Color	Code	
116 W	22,50 kg	102°	6171 lm	3000 K	●	M250011	
					○	M250021	
					●	M250041	
					●	M250031	
			6630 lm	4000 K	●	M250111	
					○	M250121	
					●	M250141	
					●	M250131	

220/240Vac 50/60Hz electronic ballast included. Dimmable Dali-SwitchDim. Supply voltage 220-240V. Insulation class II. SELV. IP20.

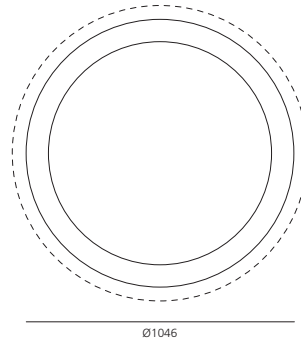

Tagora 970 LED	LED direct		luminaire direct		116 W	3000 K	$\alpha=102^\circ$	4000 K	$\alpha=102^\circ$				
	100 W	100 W	116 W	116 W									
Power	100 W	100 W	116 W	116 W		H	\varnothing	E _{Max}	E _{lux}	H	\varnothing	E _{Max}	E _{lux}
Flux	12100 lm	13000 lm	6171 lm	6630 lm		1	2,79	2091	554	1	2,79	2091	554
CCT	3000 K	4000 K	3000 K	4000 K		2	5,58	523	139	2	5,58	523	139
CRI	=80 (typ.)					3	8,38	232	62	3	8,38	232	62
Color tolerance	MacAdam 4SDCM					4	11,17	131	35	4	11,17	131	35
Service life	L70(6K) > 36000h				5	13,96	84	22	5	13,96	84	22	
Beam			102°	102°									
Efficiency			51%	51%									
Efficacy	121 lm/W	130 lm/W	53 lm/W	57 lm/W									

T16 (G5)					non dimmable		Dali-SwitchDim	
W	Weight	Beam	Flux	Color	Code		Code	
4x24 W	22,00 kg	112°	19400 lm	●	M021510	M021511	M021511	
+				○	M021520	M021521	M021521	
4x39 W				●	M021540	M021541	M021541	
				●	M021530	M021531	M021531	

220/240Vac 50/60Hz electronic ballast included.

4x24W+4x39W/19400 lm Efficiency 43% 112°

	H	\varnothing	E _{Max}	E _{lux}
	m	m	lux	lux
1	2,98		2978	258
2	5,95		745	65
3	8,93		331	29
4	11,91		186	16
5	14,88		119	10

Tagora ceiling



- Series of ceiling mounted luminaires available in 4 diameters (80 mm, 270 mm, 570 mm, 970 mm), using high-output LEDs, Retrofit LEDs, 12V halogen lamps, metal halide and fluorescent sources.
- Aluminium body available in different two-coloured versions: beige/white, grey/white, black/orange, black/vert and black/blue.
- Tagora 80 and 270 offer high-output spot light with aluminium optics. 2 beam angles for LED version and 3 for HIT version.
- Tagora 270 LED uses a proprietary system based on a hybrid combined lens and reflector optic. This system helps to create defined narrow beams using high-powered LED modules of large dimensions.
- Tagora 570 and 970 come with a PMMA diffuser, offering a comfortable diffused light. LED versions use high-output sources.
- Monochromatic LED option with warm white (3000 K) and neutral white (4000 K) tones.
- Integrated electronic power supply, dimmable or non-dimmable options, depending on the version.
- Emergency lighting available on Tagora 570 fluorescent option.
- Only ceiling mounted installation allowed.
- Compliant with standard EN60598-1 and other specific standards.



Tagora ceiling 80 LED

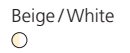
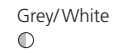
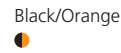

LED

non dimmable

W	Weight	Beam	Flux	CCT	Color	Code
18 W	1,15 kg	20°	655 lm	3000 K		M244610
						M244660
						M244620
						M244640
						M244630
		735 lm	4000 K		M244710	
					M244760	
					M244720	
					M244740	
					M244730	
45°		680 lm	3000 K		M244810	
					M244860	
					M244820	
					M244840	
					M244830	
		765 lm	4000 K		M244910	
					M244960	
					M244920	
					M244940	
					M244930	



IP20 \oplus
960°

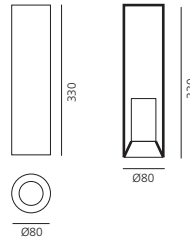

220/240Vac 50/60Hz electronic ballast included.

LED (GU10)

	Weight	Color	Code
220 V	0,98 kg		M018910
240 V*			M018960
			M018920
			M018940
			M018930

Tagora 80 LED 20°

LED	luminaire	14 W	3000 K	$\alpha=20^\circ$	4000 K	$\alpha=20^\circ$			
Power	10 W 10 W 14 W 14 W								
Flux	940 lm 1055 lm 655 lm 735 lm								
CCT	3000 K 4000 K 3000 K 4000 K								
CRI	=80 (typ.)								
Color tolerance	MacAdam 3SDCM								
Service life	L70(6K) > 50000h								
Beam	20° 20°	H	\emptyset	EMax lux	EM lux	H	\emptyset	EMax lux	EM lux
Efficiency	70 % 70 %	1	0,36	3238	2099	1	0,36	3633	2355
Efficacy	92 lm/W 103 lm/W 64 lm/W 72 lm/W	2	0,71	809	525	2	0,71	908	589
		3	1,07	360	233	3	1,07	404	262
		4	1,42	202	131	4	1,42	227	147
		5	1,78	130	84	5	1,78	145	94

Tagora 80 LED 45°

LED	luminaire	14 W	3000 K	$\alpha=45^\circ$	4000 K	$\alpha=45^\circ$			
Power	10 W 10 W 14 W 14 W								
Flux	940 lm 1055 lm 680 lm 765 lm								
CCT	3000 K 4000 K 3000 K 4000 K								
CRI	=80 (typ.)								
Color tolerance	MacAdam 3SDCM								
Service life	L70(6K) > 50000h								
Beam	45° 45°	H	\emptyset	EMax lux	EM lux	H	\emptyset	EMax lux	EM lux
Efficiency	72% 72%	1	0,82	1370	821	1	0,82	1541	924
Efficacy	92 lm/W 103 lm/W 66,5 lm/W 74 lm/W	2	1,65	343	205	2	1,65	385	231
		3	2,47	152	91	3	2,47	171	103
		4	3,29	86	51	4	3,29	96	58
		5	4,12	55	33	5	4,12	62	37

Tagora ceiling 80 HIT/HALO

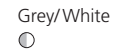
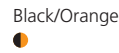

QR-CBC51 (GU5,3)

dimmable*

W	Weight
12 V	1,06 kg
max 35 W	



Code
M018210
M018260
M018220
M018240
M018230

Retrofit ▶ MASTER LEDspot MR16 (GU5,3) 12V 7 W.

220/240Vac 50/60Hz electronic ballast included.
*Leading and trailing edge dimmable.

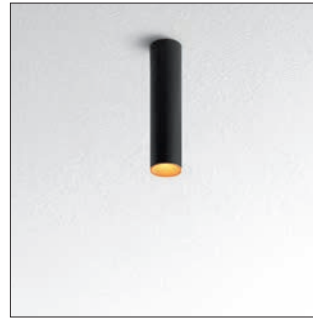

IP20 ⊕
960°

HIPAR51-CE-P (GX10)

W	Weight
20 W	1,15 kg

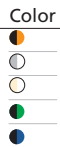

Code
M018310
M018360
M018320
M018340
M018330

220/240Vac 50/60Hz electronic ballast included.

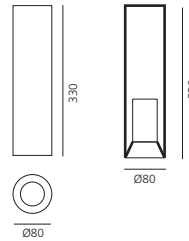

HIT-TC-CE (GU6,5)

W	Weight	Beam	Flux
23 W	1,15 kg	12°	1700 lm

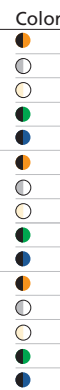

Code
M017010SP
M017060SP
M017020SP
M017040SP
M017030SP
M017010MFL
M017060MFL
M017020MFL
M017040MFL
M017040MFL
M017010FL
M017060FL
M017020FL
M017040FL
M017030FL

Beam	Flux
12°	1700 lm
26°	1700 lm
59°	1700 lm

220/240Vac 50/60Hz electronic ballast included.

23 W/1700 lm

Efficiency 42,43% α=12°

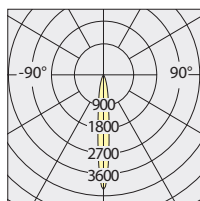

H m	Ø m	EMax lux	EM lux
1	0,20	6959	4401
2	0,39	1740	1100
3	0,59	773	489
4	0,79	435	275
5	0,98	278	176

23 W/1700 lm

Efficiency 41,85% α=26°

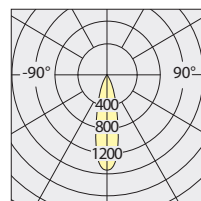

H m	Ø m	EMax lux	EM lux
1	0,47	2568	1619
2	0,93	642	405
3	1,40	285	180
4	1,87	160	101
5	2,34	103	65

23 W/1700 lm

Efficiency 81,95% α=59°

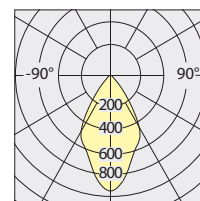

H m	Ø m	EMax lux	EM lux
1	1,13	1563	748
2	2,25	391	187
3	3,38	174	83
4	4,50	98	47
5	5,63	63	30

Tagora ceiling 270 LED

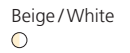
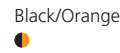

LED

W	Weight	Beam	Flux	CCT	Color
31 W	2,60 kg	16°	1400 lm	3000 K	
		32°	1310 lm	3000 K	
31 W	2,60 kg	16°	1480 lm	4000 K	
32°	1386 lm	4000 K			

Dali-SwitchDim

Code
M248411
M248461
M248421
M248441
M248431
M248511
M248561
M248521
M248541
M248531
M248611
M248661
M248621
M248641
M248631
M248711
M248761
M248721
M248741
M248731



IP20 \oplus
960°

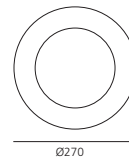
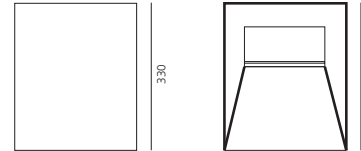

220/240Vac 50/60Hz electronic ballast included.

Tagora 270 LED 16°

LED	luminaire			
26 W	32 W	31 W	31 W	
2950 lm	3110 lm	1400 lm	1480 lm	
3000 K	4000 K	3000 K	4000 K	
CRI =80 (min.)				
Color tolerance MacAdam 3SDCM				
Service life L70(6K) > 50000h				
Beam		16°	16°	
Efficiency		48%	48%	
Efficacy		113 lm/W	118 lm/W	45 lm/W 48 lm/W

31 W	3000 K		$\alpha=16^\circ$		4000 K		$\alpha=16^\circ$	
	H m	\varnothing m	EMax lux	EM lux	H m	\varnothing m	EMax lux	EM lux
	1	0,29	12125	7697	1	0,29	12817	8137
	2	0,57	3031	1924	2	0,57	3204	2034
	3	0,86	1347	855	3	0,86	1424	904
	4	1,14	758	481	4	1,14	801	509
	5	1,43	485	308	5	1,43	513	325

Tagora 270 LED 32°

LED	luminaire			
26 W	26 W	31 W	31 W	
2950 lm	3110 lm	1310 lm	1386 lm	
3000 K	4000 K	3000 K	4000 K	
CRI =80 (min.)				
Color tolerance MacAdam 3SDCM				
Service life L70(6K) > 50000h				
Beam		32°	32°	
Efficiency		44%	44%	
Efficacy		113 lm/W	118 lm/W	42 lm/W 48 lm/W

31 W	3000 K		$\alpha=32^\circ$		4000 K		$\alpha=32^\circ$	
	H m	\varnothing m	EMax lux	EM lux	H m	\varnothing m	EMax lux	EM lux
	1	0,56	4043	2491	1	0,56	4278	2636
	2	1,13	1011	623	2	1,13	1069	659
	3	1,69	449	277	3	1,69	475	293
	4	2,26	253	156	4	2,26	267	165
	5	2,82	162	100	5	2,82	171	105

Tagora ceiling 270 HIT/Fluo

Black/Green 











Black/Blue 

Black/Orange 

Grey/White 

Beige/White 

HIT-CE (G12)

W	Weight	Beam	Flux	Color	Code
70 W	2,64 kg	42°	6300 lm		M018710
					M018760
					M018720
					M018740
					M018730
		66°	6600 lm		M018810
					M018860
					M018820
					M018840
					M018830



IP20 ⊕
960°

220/240Vac 50/60Hz electronic ballast included.

70 W/6300 lm Efficiency 61% α=42°

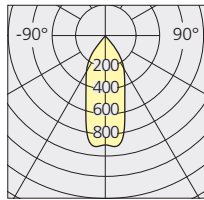

H m	Ø m	EMax lux	EM lux
1	0,75	5863	3527
2	1,50	1466	882
3	2,25	651	392
4	2,99	366	220
5	3,74	235	141

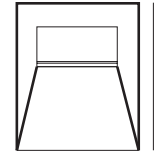
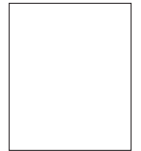



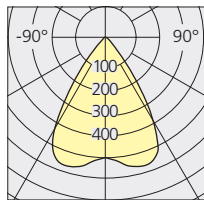

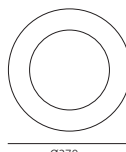

70 W/6600 lm Efficiency 71% α=66°



H m	Ø m	EMax lux	EM lux
1	1,35	2553	1294
2	2,70	638	324
3	4,05	284	144
4	5,40	160	81
5	6,75	102	52



TC-DEL (G24q-3)

W	Weight	Beam	Flux	Color
2x26 W	2,38 kg	70°	3600 lm	
				
				
				
				
				

non dimmable

Dali-SwitchDim

Code
M018510
M018560
M018520
M018540
M018530

Code
M018511
M018561
M018521
M018541
M018531





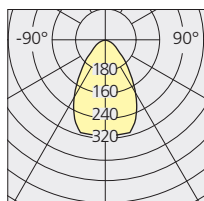

220/240Vac 50/60Hz electronic ballast included.

2x26 W/3600 lm Efficiency 46% 70°



H m	Ø m	EMax lux	EM lux
1	1,37	1091	307
2	2,75	273	77
3	4,12	121	34
4	5,50	68	19
5	6,87	44	12

TC-TEL (GR14q-1)

W	Weight	Beam	Flux	Color
2x17 W	2,38 kg	66°	3000 lm	
				
				
				
				
				

non dimmable

Dali-SwitchDim

Code
M018610
M018660
M018620
M018640
M018630

Code
M018611
M018661
M018621
M018641
M018631

220/240Vac 50/60Hz electronic ballast included.

2x17 W/3000 lm Efficiency 40% 66°

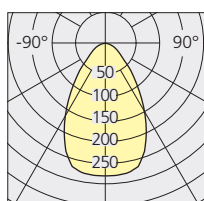

H m	Ø m	EMax lux	EM lux
1	1,31	702	206
2	2,62	176	52
3	3,93	78	23
4	5,24	44	13
5	6,54	28	8





Tagora ceiling 570

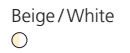
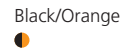

LED

W	Weight	Beam	Flux	CCT	Color
46 W	5,30 kg	102°	2175 lm	3000 K	
			2316 lm	4000 K	

Dali-SwitchDim

Code
M248211
M248261
M248221
M248241
M248231
M248311
M248361
M248321
M248341
M248331



IP40 \oplus
650°

220/240Vac 50/60Hz electronic ballast included.

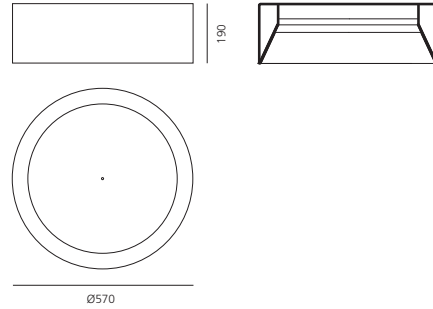

Tagora 570 LED

LED	luminaire	
40 W	40 W	46 W 46 W
4840 lm	5200 lm	2175 lm 2316 lm
3000 K	4000 K	3000 K 4000 K
CRI =80 (typ.)		
Color tolerance MacAdam 4SDCM		
Service life L70(6K) > 36000h		
Beam		102° 102°
Efficiency		45% 45%
Efficacy	121 lm/W 130 lm/W	47 lm/W 50 lm/W

46 W

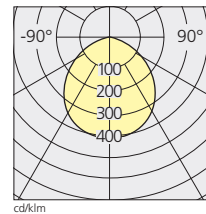

3000 K				4000 K			
$\alpha=102^\circ$				$\alpha=102^\circ$			
H _m	Ø _m	E _{Max} lux	EM lux	H _m	Ø _m	E _{Max} lux	EM lux
1	2,52	884	106	1	2,52	942	113
2	5,05	221	27	2	5,05	235	28
3	7,57	98	12	3	7,57	105	13
4	10,09	55	7	4	10,09	59	7
5	12,62	35	4	5	12,62	38	5

T16 (G5)

W	Weight	Beam	Flux	Color
4x36 W	5,20 kg	106°	11600 lm	

non dimmable

Code
M016710
M016760
M016720
M016740
M016730

+ emergency 1h

Code
M016717
M016767
M016727
M016747
M016737

Dali-SwitchDim

Code
M016711
M016761
M016721
M016741
M016731

220/240Vac 50/60Hz electronic ballast included.

4x36 W/11600 lm

Efficiency 30% 106°

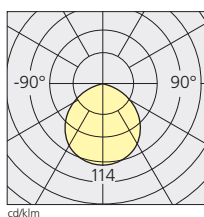

H _m	Ø _m	E _{Max} lux	EM lux
1	2,58	1364	157
2	5,16	341	39
3	7,74	152	17
4	10,31	85	10
5	12,89	55	6

cd/klm

Tagora ceiling 970

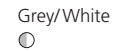
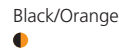

LED

W	Weight	Beam	Flux	CCT	Color
116 W	15,50 kg	102°	6171 lm	3000 K	
			6630 lm	4000 K	

Dali-SwitchDim

Code
M248011
M248061
M248021
M248041
M248031
M248111
M248161
M248121
M248141
M248131



IP40 ⊕
650°

220/240Vac 50/60Hz electronic ballast included.

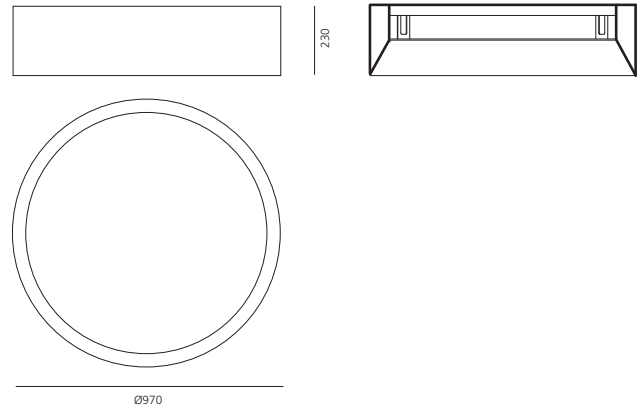

Tagora 970 LED

LED direct	luminaire direct
100 W	116 W
12100 lm	6171 lm
3000 K	3000 K
4000 K	4000 K
=80 (typ.)	
MacAdam 4SDCM	
L70(6K) > 36000h	
	102°
	51%
121 lm/W	53 lm/W

116 W	3000 K	α=102°	4000 K	α=102°

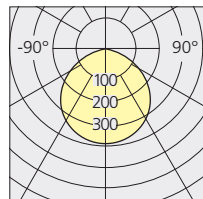

T16 (G5)

W	Weight	Beam	Flux	Color
4x24 W	15,00 kg	112°	19400 lm	
+ 4x39 W				

non dimmable

Code
M017710
M017760
M017720
M017740
M017730

Dali-SwitchDim

Code
M017711
M017761
M017721
M017741
M017731

220/240Vac 50/60Hz electronic ballast included.

4x24W+4x39W/19400 lm Efficiency 43% 112°

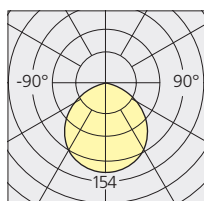

H m	Ø m	EMax lux	EM lux
1	2,98	2978	258
2	5,95	745	65
3	8,93	331	29
4	11,91	186	16
5	14,88	119	10

cd/klm





Vodafone Campus - Düsseldorf (Germany)
Arch.: HPP, Henrich-Petschnigg & Partner, Photo: Werner Huthmacher

Tagora suspension



- Series of suspended luminaires available in 4 diameters (80 mm, 270 mm, 570 mm, 970 mm), using high-output LEDs, Retrofit LEDs, 12V halogen lamps, metal halide and fluorescent sources.
- Aluminium body available in different two-coloured versions: beige/white, grey/white, black/orange, black/vert and black/blue.
- Steel suspension cables allowing quick adjustment, 2 metre length.
- Tagora 80 and 270 offer a high-output spot light with aluminium optics. 2 beam angles for LED versions and 3 for HIT versions.
- Tagora 270 LED uses a proprietary system based on a hybrid combined lens and reflector optic. This system helps to create defined narrow beams using high-powered LED modules of large dimensions.
- Tagora 570 and 970 come with a PMMA diffuser, offering a comfortable diffused light. LED versions use high-output sources.
- Monochromatic LED option with warm white (3000 K) and neutral white (4000 K) tones.
- Integrated electronic power supply, dimmable or non-dimmable options, depending on the version.
- Emergency lighting available on Tagora 570 fluorescent option.
- Option of double light emission available on Tagora 570 and 970 fluorescent modules.
- Compliant with standard EN60598-1 and other specific standards.



Tagora suspension 80 LED

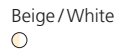
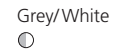
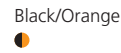

LED

non dimmable

W	Weight	Beam	Flux	CCT	Color	Code
14 W	1,20 kg	20°	655 lm	3000 K		M247610
						M247660
						M247620
						M247640
						M247630
		735 lm	4000 K		M247710	
					M247760	
					M247720	
					M247740	
					M247730	
45°	1,20 kg	680 lm	3000 K		M247810	
					M247860	
					M247820	
					M247840	
					M247830	
		756 lm	4000 K		M247910	
					M247960	
					M247920	
					M247940	
					M247930	



IP20 \oplus
960°

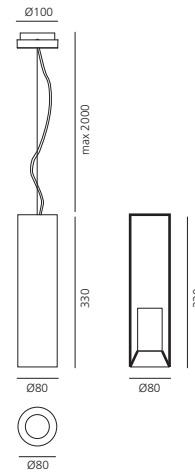

220/240Vac 50/60Hz electronic ballast included.

LED (GU10)

Weight	Color	Code
220 V 1,03 kg		M019110
240 V*		M019160
		M019120
		M019140
		M019130

*Max 81mm (overall)

Tagora 80 LED 20°

LED	luminaire	14 W	3000 K	$\alpha=20^\circ$	4000 K	$\alpha=20^\circ$
Power	10 W 10 W	14 W	14 W			
Flux	940 lm 1055 lm	655 lm	735 lm			
CCT	3000 K 4000 K	3000 K	4000 K			
CRI	=80 (typ.)					
Color tolerance	MacAdam 3SDCM					
Service life	L70(6K) > 50000h					
Beam		20°	20°			
Efficiency		70 %	70 %			
Efficacy	92 lm/W 103 lm/W	64 lm/W	72 lm/W			

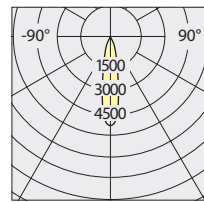

Tagora 80 LED 45°

LED	luminaire	14 W	3000 K	$\alpha=45^\circ$	4000 K	$\alpha=45^\circ$
Power	10 W 10 W	14 W	14 W			
Flux	940 lm 1055 lm	680 lm	765 lm			
CCT	3000 K 4000 K	3000 K	4000 K			
CRI	=80 (typ.)					
Color tolerance	MacAdam 3SDCM					
Service life	L70(6K) > 50000h					
Beam		45°	45°			
Efficiency		72 %	72 %			
Efficacy	92 lm/W 103 lm/W	66,5 lm/W	74 lm/W			

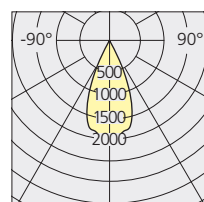

Tagora suspension 80 HIT/HALO

Black/Green

Black/Blue

Black/Orange

Grey/White

Beige/White

QR-CBC51 (GU5,3)

W	Weight
12 V	1,12 kg
max 35 W	

retrofit ▶ MASTER LEDspot MR16 (GU5,3) 12V 7 W
*Leading and trailing edge dimmable.

- Color
- -
 -
 -
 -

dimmable*

Code
M017810
M017860
M017820
M017840
M017830



IP20 ⊕
960°

220/240Vac 50/60Hz electronic ballast included.

HIPAR51-CE-P (GX10)

W	Weight
20 W	1,20 kg

- Color
- -
 -
 -
 -

Code
M019210
M019260
M019220
M019240
M019230

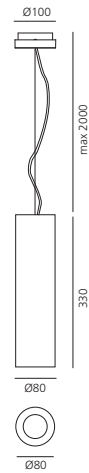

HIT-TC-CE (GU6,5)

W	Weight	Beam	Flux	Color	Code		
23 W	1,20 kg	12°	1700 lm	●	M019310SP		
				○	M019360SP		
				○	M019320SP		
		27°	1700 lm	●	M019340SP		
				●	M019330SP		
				○	M019310MFL		
		59°	1700 lm	○	M019360MFL		
				○	M019320MFL		
				●	M019340MFL		
						●	M019330MFL
						○	M019310FL
						○	M019360FL
						○	M019320FL
						●	M019340FL
						●	M019330FL

220/240Vac 50/60Hz electronic ballast included.

23 W/1700 lm

Efficiency 42,43% α=12°

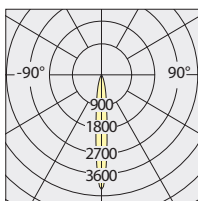

H m	Ø m	EMax lux	EM lux
1	0,20	6959	4401
2	0,39	1740	1100
3	0,59	773	489
4	0,79	435	275
5	0,98	278	176

23 W/1700 lm

Efficiency 41,85% α=27°

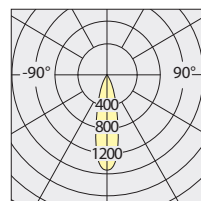

H m	Ø m	EMax lux	EM lux
1	0,47	2568	1619
2	0,93	642	405
3	1,40	285	180
4	1,87	160	101
5	2,34	103	65

23 W/1700 lm

Efficiency 81,95% α=59°

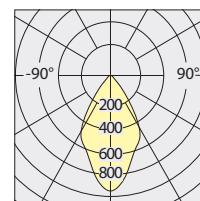

H m	Ø m	EMax lux	EM lux
1	1,13	1563	748
2	2,25	391	187
3	3,38	174	83
4	4,50	98	47
5	5,63	63	30

Tagora suspension 270 LED

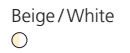
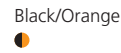

LED

W (Led)	Weight	Beam	Flux	CCT	Color
31 W	2,68 kg	16°	1400 lm	3000 K	
		32°	1310 lm	3000 K	
32°	1386 lm	4000 K			

DALI-SwitchDim

Code
M249611
M249661
M249621
M249641
M249631
M249711
M249761
M249721
M249741
M249731
M249811
M249861
M249821
M249841
M249831
M249911
M249961
M249921
M249941
M249931



IP20 \oplus
960°

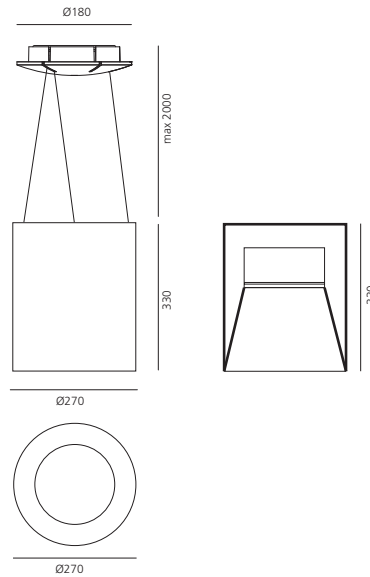

220/240Vac 50/60Hz electronic ballast included.

Tagora 270 LED 16°

	LED		luminaire	
Power	26 W	26 W	31 W	31 W
Flux	2950 lm	3110 lm	1400 lm	1480 lm
CCT	3000 K	4000 K	3000 K	4000 K
CRI	=80 (min.)			
Color tolerance	MacAdam 3SDCM			
Service life	L70(6K) > 50000h			
Beam			16°	16°
Efficiency			48%	48%
Efficacy	113 lm/W	118 lm/W	45 lm/W	48 lm/W

31 W

3000 K

$\alpha=16^\circ$

4000 K

$\alpha=16^\circ$

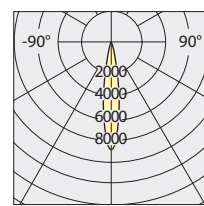

H m	\emptyset m	EMax lux	EM lux	H m	\emptyset m	EMax lux	EM lux
1	0,29	12125	7697	1	0,29	12817	8137
2	0,57	3031	1924	2	0,57	3204	2034
3	0,86	1347	855	3	0,86	1424	904
4	1,14	758	481	4	1,14	801	509
5	1,43	485	308	5	1,43	513	325

Tagora 270 LED 32°

	LED		luminaire	
Power	26 W	26 W	31 W	31 W
Flux	2950 lm	3110 lm	1310 lm	1386 lm
CCT	3000 K	4000 K	3000 K	4000 K
CRI	=80 (min.)			
Color tolerance	MacAdam 3SDCM			
Service life	L70(6K) > 50000h			
Beam			32°	32°
Efficiency			44%	44%
Efficacy	113 lm/W	118 lm/W	42 lm/W	48 lm/W

31 W

3000 K

$\alpha=32^\circ$

4000 K

$\alpha=32^\circ$

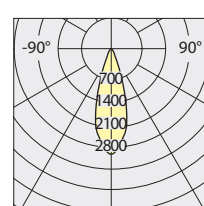



H m	\emptyset m	EMax lux	EM lux	H m	\emptyset m	EMax lux	EM lux
1	0,56	4043	2491	1	0,56	4278	2636
2	1,13	1011	623	2	1,13	1069	659
3	1,69	449	277	3	1,69	475	293
4	2,26	253	156	4	2,26	267	165
5	2,82	162	100	5	2,82	171	105

Tagora suspension 270 HIT/Fluo

Black/Green 











Black/Blue 

Black/Orange 

Grey/White 

Beige/White 

HIT-CE (G12)

W	Weight	Beam	Flux	Color	Code
70 W	2,68 kg	42°	6300 lm		M019610
					M019660
					M019620
					M019640
					M019630
		66°	6600 lm		M019710
					M019760
					M019720
					M019740
					M019730



IP20 \oplus
960°

220/240Vac 50/60Hz electronic ballast included.

70 W/6300 lm Efficiency 61% $\alpha=42^\circ$

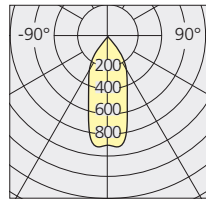

H m	Ø m	EMax lux	EM lux
1	0,75	5863	3527
2	1,50	1466	882
3	2,25	651	392
4	2,99	366	220
5	3,74	235	141



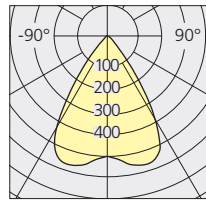

70 W/6600 lm Efficiency 71% $\alpha=66^\circ$

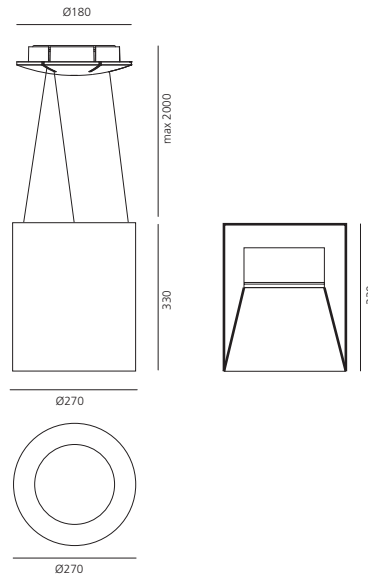

H m	Ø m	EMax lux	EM lux
1	1,35	2553	1294
2	2,70	638	324
3	4,05	284	144
4	5,40	160	81
5	6,75	102	52



TC-DEL (G24q-3)

W	Weight	Beam	Flux	Color	Code
2x26 W	2,38 kg	70°	3600 lm		M019510
					M019560
					M019520
					M019540
					M019530

non dimmable

Dali-SwitchDim



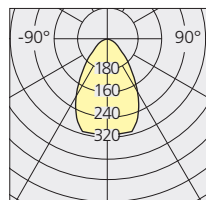

220/240Vac 50/60Hz electronic ballast included.

2x26 W/3600 lm Efficiency 46% 70°



H m	Ø m	EMax lux	EM lux
1	1,37	1091	307
2	2,75	273	77
3	4,12	121	34
4	5,50	68	19
5	6,87	44	12

TC-TEL (GR14q-1)

W	Weight	Beam	Flux	Color	Code
2x17 W	2,38 kg	66°	3000 lm		M019410
					M019460
					M019420
					M019440
					M019430

non dimmable

Dali-SwitchDim

220/240Vac 50/60Hz electronic ballast included.

2x17 W/3000 lm Efficiency 40% 66°

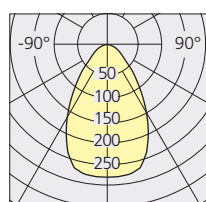

H m	Ø m	EMax lux	EM lux
1	1,31	702	206
2	2,62	176	52
3	3,93	78	23
4	5,24	44	13
5	6,54	28	8

Tagora suspension 570 Fluo

Black/Green

Black/Blue

Black/Orange

Grey/White

Beige/White

TC-LEL (2G11) Direct emission

W	Weight	Beam	Flux	Color
4x36 W	6,70 kg	106°	11600 lm	●
				○
				○
				●
				●

non dimmable

Code
M016810
M016860
M016820
M016840
M016830

+ emergency 1h

Code
M016817
M016867
M016827
M016847
M016837



IP40
650°

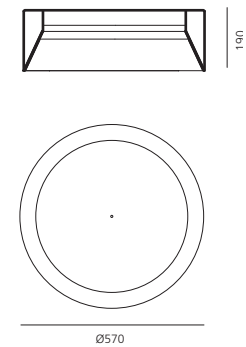
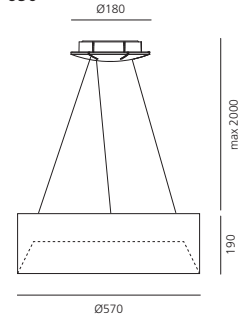

220/240Vac 50/60Hz electronic ballast included.

TC-LEL (2G11) Direct + indirect emission

W	Weight	Beam	Flux	Color
4x36 W	6,70 kg	106°	11600 lm	●
				○
				○
				●
				●

non dimmable

Code
M016910
M016960
M016920
M016940
M016930

+ emergency 1h

Code
M016917
M016967
M016927
M016947
M016937

Dali-SwitchDim

Color	Code
●	M016911
○	M016961
○	M016921
●	M016941
●	M016931

220/240Vac 50/60Hz electronic ballast included.

Single power supply for both direct and indirect emission..

4x36 W/11600 lm

Efficiency 30% 106°

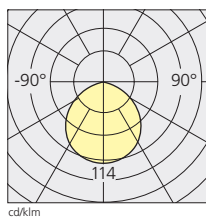

H	Ø	EMax	EM
m	m	lux	lux
1	2,58	1364	157
2	5,16	341	39
3	7,74	152	17
4	10,31	85	10
5	12,89	55	6

4x36 W/11600 lm

Efficiency 41% 106°

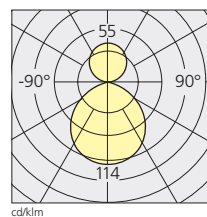

H	Ø	EMax	EM
m	m	lux	lux
1	2,66	1239	135
2	5,33	310	34
3	7,99	138	15
4	10,65	77	8
5	13,32	50	5

Tagora suspension 970 LED

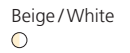
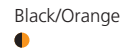

LED Direct emission

W	Weight	Beam	Flux	CCT	Color	Dali-SwitchDim	Code
116 W	21,50 kg	102°	6171 lm	3000 K			M248811
							M248861
							M248821
							M248841
							M248831
		6630 lm	4000 K			M248911	
						M248961	
						M248921	
						M248941	
						M248931	



IP40

650°

220/240Vac 50/60Hz electronic ballast included.

LED Direct + indirect emission

W	Weight	Beam	Flux	CCT	Color	Dali-SwitchDim	Code
122 W	21,50 kg	108°	6930 lm	3000 K			M250811
							M250861
							M250821
							M250841
							M250831
		6930 lm	4000 K			M250911	
						M250961	
						M250921	
						M250941	
						M250931	

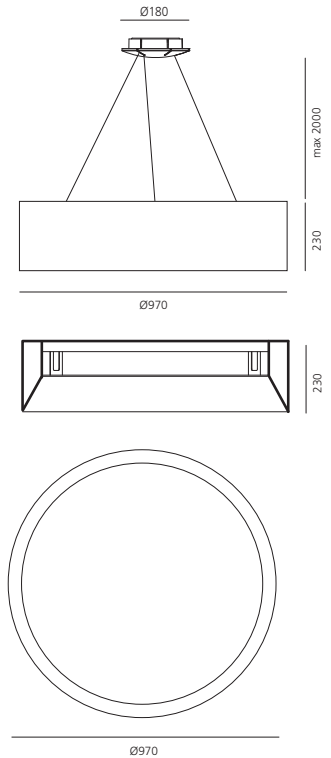

220/240Vac 50/60Hz electronic ballast included.

Tagora 970 LED

LED direct luminaire direct

	100 W	100 W	116 W	116 W
Power	100 W	100 W	116 W	116 W
Flux	12100 lm	13000 lm	6171 lm	6630 lm
CCT	3000 K	4000 K	3000 K	4000 K
CRI	=80 (typ.)			
Color tolerance	MacAdam 4SDCM			
Service life	L70(6K) > 36000h			
Beam			102°	102°
Efficiency			51%	51%
Efficacy	121 lm/W	130 lm/W	53 lm/W	57 lm/W

116 W 3000 K α=102° 4000 K α=102°

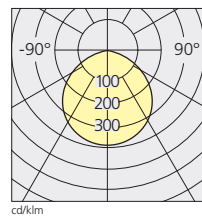

H m	Ø m	EMax lux	EM lux	H m	Ø m	EMax lux	EM lux
1	2,79	2091	554	1	2,79	2091	554
2	5,58	523	139	2	5,58	523	139
3	8,38	232	62	3	8,38	232	62
4	11,17	131	35	4	11,17	131	35
5	13,96	84	22	5	13,96	84	22

LED direct/indirect luminaire direct/indirect

	108 W	108 W	122 W	122 W
Power	108 W	108 W	122 W	122 W
Flux	15600 lm	15600 lm	6930 lm	6930 lm
CCT	3000 K	4000 K	3000 K	4000 K
CRI	=80 (typ.)			
Color tolerance	MacAdam 3SDCM			
Service life	L70(6K) > 50000h			
Beam			108°	108°
Efficiency			44%	44%
Efficacy	144 lm/W	144 lm/W	57 lm/W	57 lm/W

122 W 3000 K α=108° 4000 K α=108°

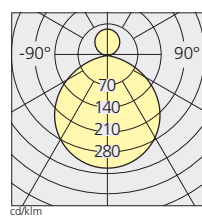

H m	Ø m	EMax lux	EM lux	H m	Ø m	EMax lux	EM lux
1	2,79	2091	554	1	2,79	2091	554
2	5,58	523	139	2	5,58	523	139
3	8,38	232	62	3	8,38	232	62
4	11,17	131	35	4	11,17	131	35
5	13,96	84	22	5	13,96	84	22

Tagora suspension 970 Fluo

Black/Green
●

Black/Blue
●

Black/Orange
●

Grey/White
○

Beige/White
○

T16 (G5) Direct emission

W	Weight	Beam	Flux	Color
4x24 W	21,00 kg	112°	19400 lm	●
+ 4x39 W				○
				○
				●
				●

non dimmable

Code
M019910
M019960
M019920
M019940
M019930

Dali-SwitchDim

Code
M019911
M019961
M019921
M019941
M019931



220/240Vac 50/60Hz electronic ballast included.

IP40

650°

4x24W+4x39W/19400 lm Efficiency 43% 112°

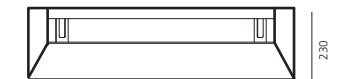
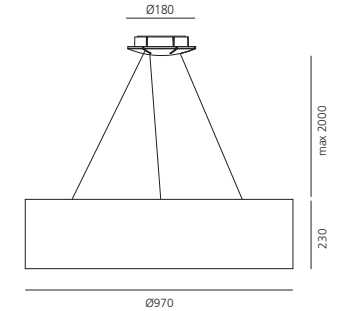
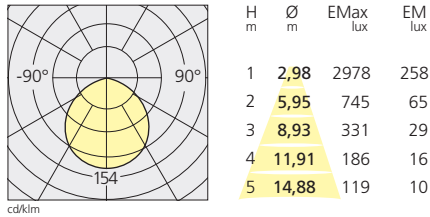

T16 (G5) Direct + indirect emission

W	Weight	Beam	Flux	Color
4x24 W	21,00 kg	112°	19400 lm	●
+ 4x39 W				○
				○
				●
				●

non dimmable

Code
M020110
M020160
M020120
M020140
M020130

Dali-SwitchDim

Code
M020111
M020161
M020121
M020141
M020131

220/240Vac 50/60Hz electronic ballast included.

Single power supply for both direct and indirect emission.

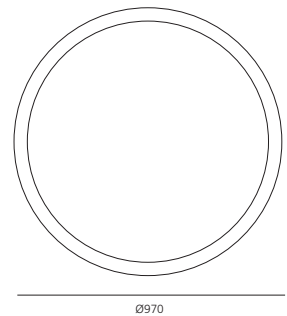

4x24W+4x39W/19400 lm Efficiency 59% 112°

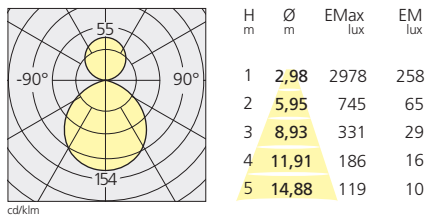

- A range of ceiling and suspension lights using high-performing led, metal-halide, fluorescent and 12 V halogen lamps.
- Aluminium body.
- Beam angles: 16°, 36°.
- Well defined, narrow beams thanks to a hybrid optic system.
- Super pure aluminium optics and protection glass with hit version.
- Fluorescent version comes with a prismoptic diffuser, and an optional blue filter that provides a decorative peripheral lighting effect.
- Available in warm white (3000K) and neutral white (4000K) – RA=80.
- Electronic or dimmable electronic driver.
- Steel suspension cables allowing quick adjustment.
- Compliant to standard EN62471, EN60598-1 and other specific regulations.



Ourea 156 LED ceiling

White
○

LED						non dimmable	Dali-SwitchDim
W	Weight	Beam	Flux	CCT	Color	Code	Code
36 W	2,95 kg	16°	2072 lm	3000 K	○	M174220	M174221
			2217 lm	4000 K	○	M174320	M174321
		36°	1900 lm	3000 K	○	M175820	M175821
			2032 lm	4000 K	○	M175920	M175921

220/240Vac 50/60Hz electronic ballast included.

QR111 (G53)				
W	Weight	Beam	Color	Code
12V max100W	2,30Kg	52°	○	M157520

retrofit ► LED AR111 (G53) 12V 12W

QR111 halogen version with Integral electronic transformer
35-105W, 230-240V/12V.
Dimmable by trailing edge external dimmers.

HIT-CE (G12)					
W	Weight	Beam	Flux	Color	Code
35W	2,50Kg	46°	3300lm	○	M157420
		66°		○	M157620
70W	2,50Kg	46°	6600lm	○	M157720
		66°		○	M157820

Ourea 156 LED suspension

LED						non dimmable	Dali-SwitchDim
W	Weight	Beam	Flux	CCT	Color	Code	Code
36 W	3,40 kg	16°	2072 lm	3000 K	○	M175420	M175421
			2217 lm	4000 K	○	M175520	M175521
		36°	1900 lm	3000 K	○	M175620	M175621
			2032 lm	4000 K	○	M175720	M175721

220/240Vac 50/60Hz electronic ballast included.

QR111 (G53)				
W	Weight	Beam	Color	Code
12V max100W	2,30Kg	52°	○	M178820

retrofit ► LED AR111 (G53) 12V 12W

QR111 halogen version with Integral electronic transformer
35-105W, 230-240V/12V.
Dimmable by trailing edge external dimmers.

HIT-CE (G12)					
W	Weight	Beam	Flux	Color	Code
35W	2,50Kg	46°	3300lm	○	M178920
		66°		○	M179020
70W	2,50Kg	46°	6600lm	○	M179120
		66°		○	M179220



IP20 ⊕ 850°

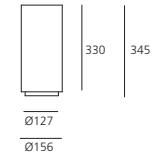

IP20 ⊕ 850°

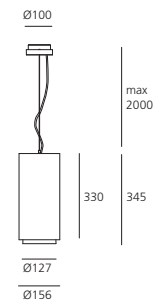

Ourea 156 LED

LED	luminaire	
Power	31 W	36 W
Flux	3454 lm	2072 lm
CCT	3000 K	3000 K
CRI	=80 (min.)	
Color tolerance	MacAdam 3SDCM	
Service life	L70(6K) > 36000h	
Beam	16°	16°
Efficiency	55%	55%
Efficacy	111lm/W	54 lm/W

36 W	3000 K		α=16°		4000 K		α=16°	
	H _m	Ø _m	EMax _{lux}	EM _{lux}	H _m	Ø _m	EMax _{lux}	EM _{lux}
	1	0,28	15922	9923	1	0,28	17037	10618
	2	0,57	3981	2481	2	0,57	4259	2654
	3	0,85	1769	1103	3	0,85	1893	1180
	4	1,14	995	620	4	1,14	1065	664
	5	1,42	637	397	5	1,42	681	425

LED	luminaire	
Power	31 W	36 W
Flux	3454 lm	1900 lm
CCT	3000 K	3000 K
CRI	>80 (min.)	
Color tolerance	MacAdam 3SDCM	
Service life	L70(6K) > 36000h	
Beam	36°	36°
Efficiency	55%	55%
Efficacy	111lm/W	54 lm/W

36 W	3000 K		α=36°		4000 K		α=36°	
	H _m	Ø _m	EMax _{lux}	EM _{lux}	H _m	Ø _m	EMax _{lux}	EM _{lux}
	1	0,67	3872	2592	1	0,67	4143	2773
	2	1,33	968	648	2	1,33	1036	693
	3	2,00	430	288	3	2,00	460	308
	4	2,66	242	162	4	2,66	259	173
	5	3,33	155	104	5	3,33	166	111

35 W/3300 lm

Efficiency 72% α=46°

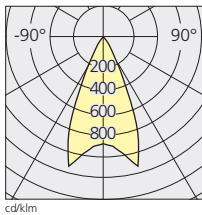

H _m	Ø _m	EMax _{lux}	EM _{lux}
1	0,82	3435	1804
2	1,65	859	451
3	2,47	382	200
4	3,30	215	113
5	4,12	137	72

35 W/3300 lm

Efficiency 77% α=66°

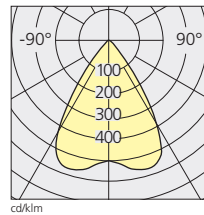

H _m	Ø _m	EMax _{lux}	EM _{lux}
1	1,30	1141	788
2	2,61	285	197
3	3,91	127	88
4	5,22	71	49
5	6,52	46	32

70 W/6600 lm

Efficiency 67% α=46°

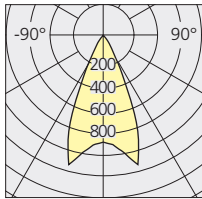

H _m	Ø _m	EMax _{lux}	EM _{lux}
1	0,86	5928	2883
2	1,72	1482	721
3	2,58	659	320
4	3,45	370	180
5	4,31	237	115

70 W/6600 lm

Efficiency 71% α=66°

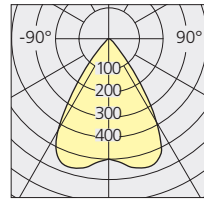

H _m	Ø _m	EMax _{lux}	EM _{lux}
1	1,35	2553	1294
2	2,70	638	324
3	4,05	284	144
4	5,40	160	81
5	6,75	102	52





Mouette

Mouette mini

Wilmotte & Industries
2004
2010
2013



- Suspension light fitting with diffused emission using 24w and 54w T16 linear fluorescent lamps (Mouette) and 2x36w (Mouette mini).
- Versions: Mouette symmetric, Mouette asymmetric, Mouette mini.
- Solid opal diffuser in moulded polypropylene.
- Luminous flux distribution: 74% in direct emission, 26% in indirect emission.
- Mouette: electronic or integrated DSI dimmable electronic ballast.
- Mouette mini: electronic ballast in a specific power-supply holder in injection moulded thermoplastic material, located along the suspension cable.
- The upper structure of the light fitting presents an access hatch for the installation of the light sources and their replacement.
- The light fitting is equipped with quick-adjustment steel suspension cables, ceiling plate and power cable.
- Cable length: Mouette: 2m or 6m, Mouette mini: 2m.
- T16 (3000k) light sources included.
- Complies with standard EN60598-1 and other specific standards.



Mouette symmetric

Opal white
○

T16 (G5)

W	Weight	Cable length	Color
4x54 W	8,50 kg	1900mm	○
	8,60 kg	5900mm	○

non dimmable

Code
L864000
L864050

DSI dimmable

Code
L864100
L864150



Light sources (3000K) included.
220/240Vac 50/60Hz electronic ballast included.

IP40/20

960°

T16 (G5)

Efficiency 58%

216W 17800lm

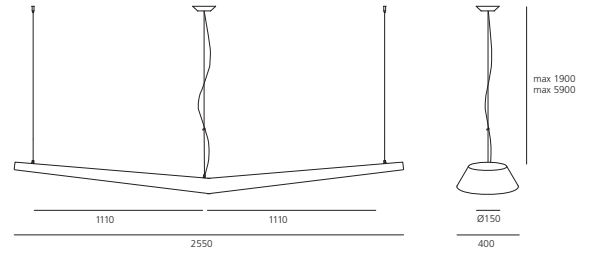
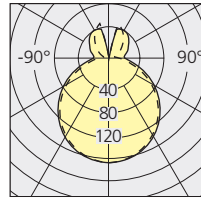

Mouette symmetric

T16 (G5)

W	Weight	Cable length	Color
4x24 W	5,40 kg	1900mm	○
	5,50 kg	5900mm	○

non dimmable

Code
L860610
L860650

DSI dimmable

Code
L860710
L860750



IP40/20

960°

T16 (G5)

Efficiency 68%

96W 7000lm

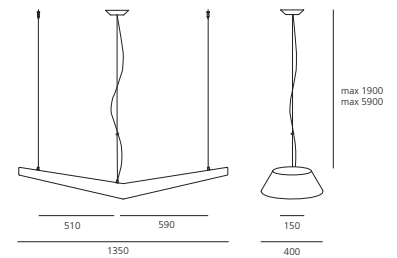
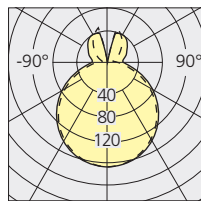



Mouette asymmetric

Opal white
○

T16 (G5)

W	Weight	Cable length	Color
2x24 W	6,80 kg	1900mm	○
+ 2x54 W	6,90 kg	5900mm	○

non dimmable

Code
L860410
L860450

DSI dimmable

Code
L860510
L860550



IP40/20

960°

Light sources (3000K) included.
220/240Vac 50/60Hz electronic ballast included.

T16 (G5)

Efficiency 67%

156W 12400lm

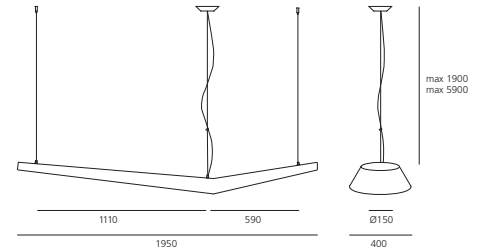
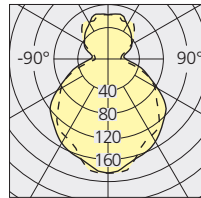

Mouette mini

TC-LEL (2G11)

W	Weight	Cable length	Color
2x36 W	3,50 kg	1900mm	○

non dimmable

Code
L860810

Light sources (3000K) included.
220/240Vac 50/60Hz electronic ballast included.



IP40/20

960°

TC-LEL (2G11)

Efficiency 71%

72W 5600lm

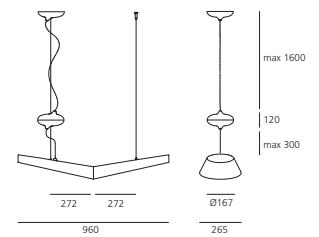
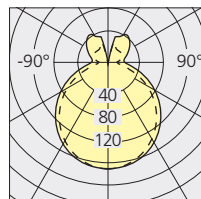









- Twist is a pendant light using T16-Seamless fluorescent tubes.
- The luminaire consists of a one-piece rotomoulded opaline diffuser in polyethylene and ballast-holder in extruded aluminium.
- Lamp maintenance is particularly easy: lamps are accessed individually from above each side without the need to remove the diffuser.
- Electronic and dimmable electronic control gear (Dali).
- Quick adjustment 6m-long steel suspension cables.
- Thanks to the use of a specific mechanical connector that can be attached to one or more corners of the luminaire, various light shapes can be created: in line, clusters or in a random pattern.
- Light sources to be ordered separately.
- Complies with standard EN60598-1 and other specific standards.



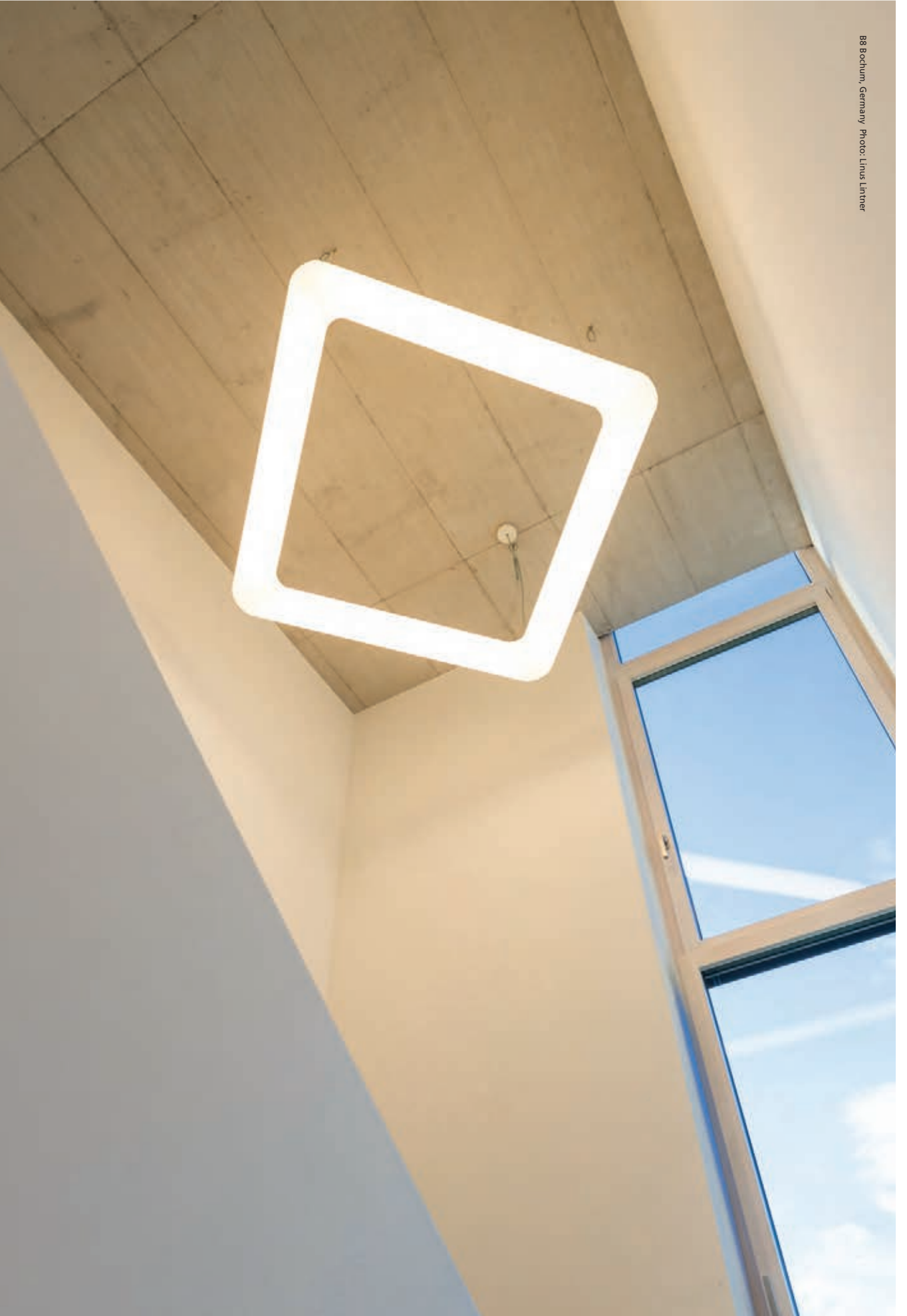

Twist

Opal white
○

T16 -SLS (G5)			
W	Weight	Flux	Color
8x54 W	16,00 kg	35600 lm	○
8x28 W	16,00 kg	20800 lm	○

Non dimmable
Code
M240100

Dimmable Dali
Code
M240101
M240101

220/240Vac 50/60Hz electronic ballast included.



T16-SLS

Efficiency 61%

8x28 W 20880 lm
8x54 W 35600 lm

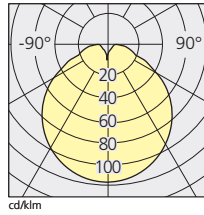

IP40/20 ☹

650°

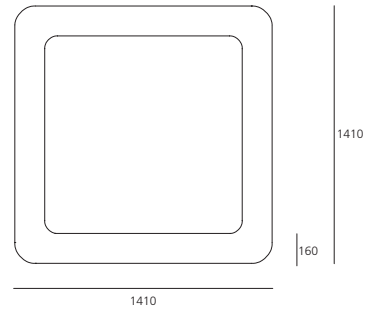
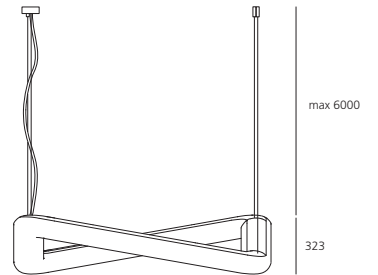

Absolu

Design office
2010





- Single pendant luminaire with diffused lighting using 54 W T16-Seamless fluorescent lamps.
- 2 length options: 2400 mm (2x54 W) and 4800 mm (4x54 W).
- Continuous solid diffuser in opaline polycarbonate.
- Structure made from extruded aluminium.
- T16-seamless equipment gives a uniform light emission without shadows.
- A simple locking/unlocking system with smart hinge allows for easy lamp maintenance.
- Electronic ballast or dali-switchdim dimmable multiwatt electronic ballast.
- Luminaire comes complete with 6m-long quick-adjustment steel suspension cables, ceiling plate and power cable.
- Complies with standard EN60598-1 and other specific standards.

Absolu

Opal white
○

T16-Seamless (G5)

W	Flux	Length		Color
2x54W	8900 lm	2456mm	9,50Kg	○
2x28W	5200 lm	2456mm	9,50Kg	○
4x54W	17800 lm	4830mm	18,50Kg	○
4x28W	10400 lm	4830mm	18,50Kg	○

Non dimmable

Code
M113300
M113400

Dali-SwitchDim

Code
M113301
M113301
M113401
M113401



220/240Vac 50/60Hz electronic ballast included.

Absolu M113401 light fittings are equipped with 2 power supplies and therefore occupy 2 DALI addresses.

IP40 ☹

850°

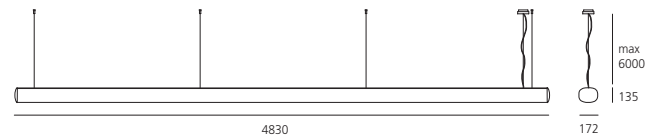
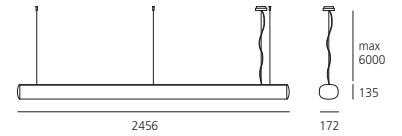

T16

Efficiency 69%

2x28W	5200lm
2x54W	8900lm
4x28W	10400lm
4x54W	17800lm

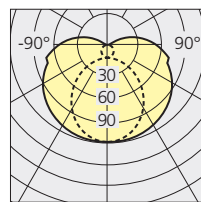

cd/klm

— C0 - C180
- - - C90 - C270

Light sources



Fluorescent tube
T16-Seamless (G5)

(1 piece)

54W

3000K

4000K

28W

3000K

4000K

Code

M004800

M004805

M004810

M004815

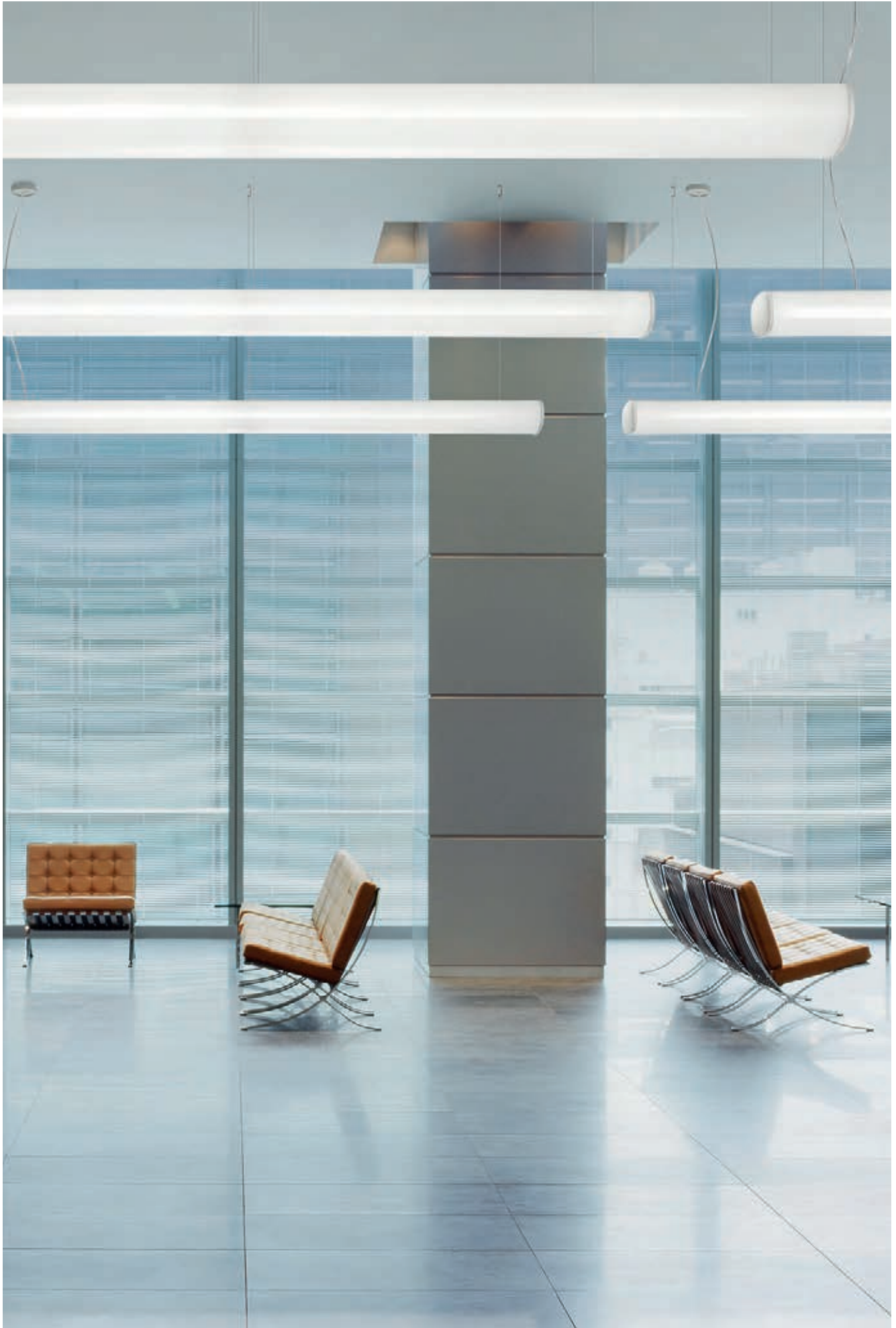

Kao

Bruno Houssin
2007

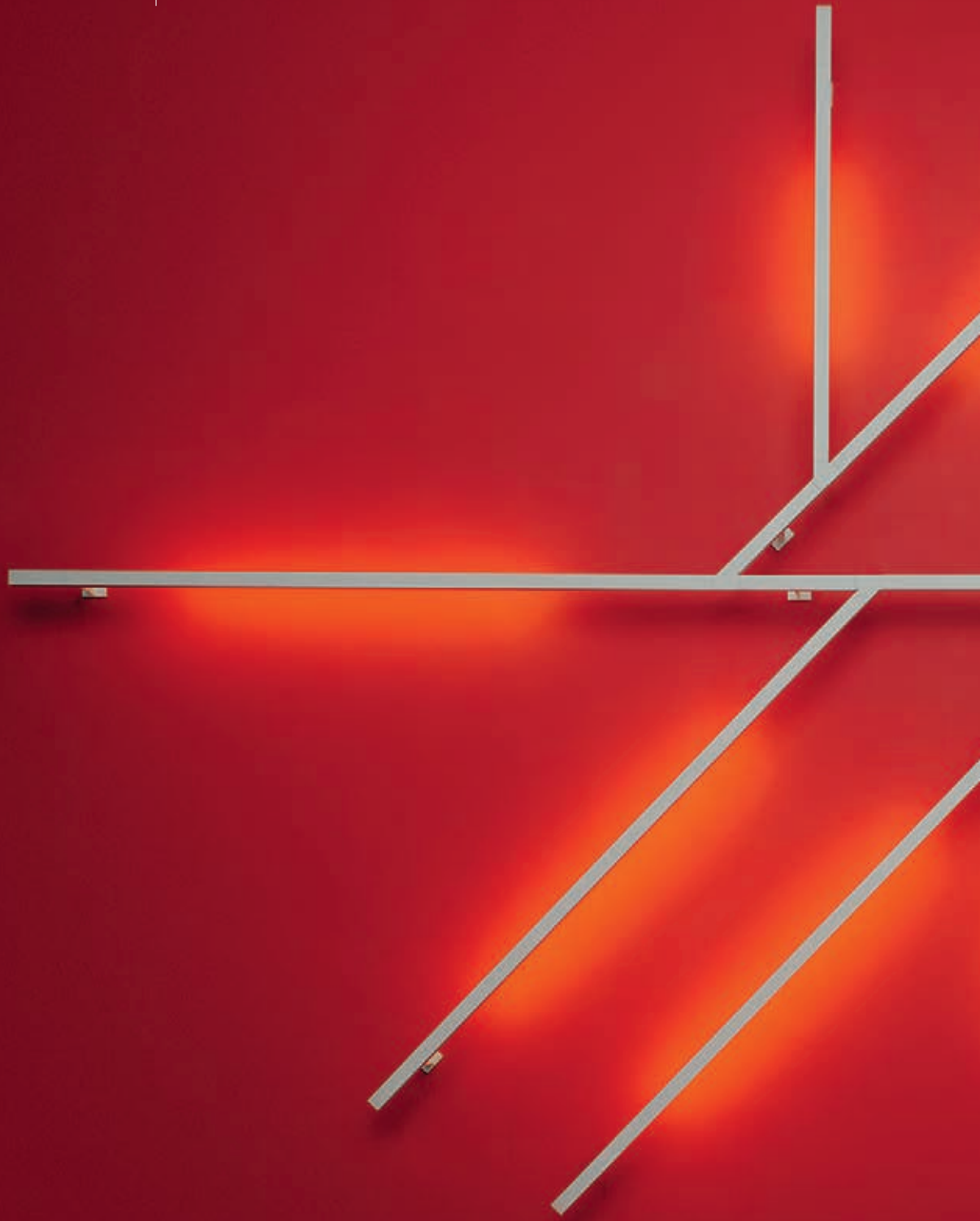



red dot design award
best of the best 2009



- Series of suspended lighting structures with indirect lighting using 24W and 54W T16 fluorescent lamps, intended to illuminate of spaces such as entrance halls, reception areas, corridors, meeting rooms, etc.
- 4 standard versions.
- Luminaires are made from aluminium with white paint finish.
- 40x40mm square section modules.
- Each structure consists of pre-assembled and pre-wired sub-units.
- Electrical connection is made via quick connectors.
- Electronic control gear.
- 6m-long steel suspension cable.
- Dust protection screen in transparent polycarbonate.
- The kits are delivered with a drilling stencil for placing the ceiling fixing points.
- Complies with standard EN60598-1 and other specific standards.

- Series of wall- or ceiling-mounted lighting structures with indirect lighting using 24W and 54W T16 fluorescent lamps, intended to illuminate of spaces such as entrance halls, reception areas, corridors, meeting rooms, etc.
- 3 standard versions.
- Luminaires are made from aluminium with white paint finish.
- 40x40mm square section modules.
- Distance to wall or ceiling: 160mm.
- Each structure consists of pre-assembled and pre-wired sub-units.
- Electrical connection is made via quick connectors.
- Electronic control gear.
- Dust protection screen in transparent polycarbonate.
- The kits are delivered with a drilling stencil for placing the fixing points.
- Complies with standard EN60598-1 and other specific standards.





Kao suspension

○
White

Kit A

T16 (G5)

W	Weight	Flux	Code
2x24W + 2x54W	12,50Kg	3500 lm +8900 lm	M119120

220/240Vac 50/60Hz electronic ballast included.

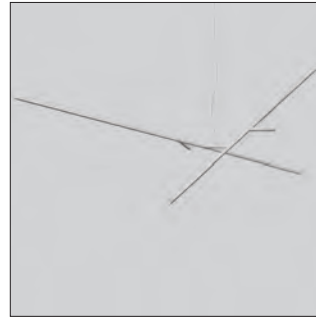

IP20 ⊕
850°

T16

Efficiency 34%	2x24 W 2x54W	3500 lm 8900 lm
----------------	-----------------	--------------------

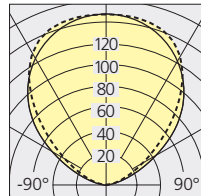

cd/klm
 — C0 - C180
 - - - C90 - C270

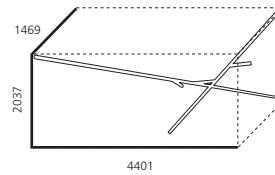

Kit B

T16 (G5)

W	Weight	Flux	Code
1x24W + 1x54W	10,50Kg	1750 lm +4450 lm	M119220

220/240Vac 50/60Hz electronic ballast included.

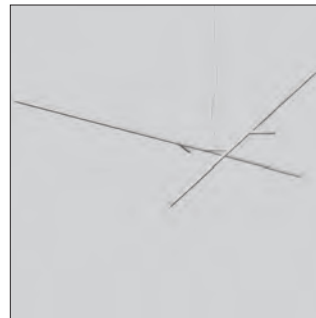

IP20 ⊕
850°

T16

Efficiency 34%	1x24 W 1x54 W	1750 lm 4450 lm
----------------	------------------	--------------------

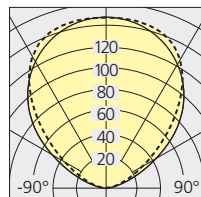

cd/klm
 — C0 - C180
 - - - C90 - C270

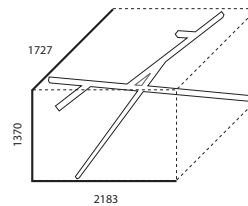

Kao suspension

○ White

Kit C

T16 (G5)

W	Weight	Flux
2x54W	8,80Kg	8900 lm

Code
M119320

220/240Vac 50/60Hz electronic ballast included.

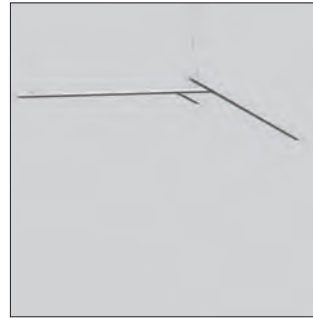

IP20 ⊕
850°

T16

Efficiency 34%	2x54 W	8900 lm
----------------	--------	---------

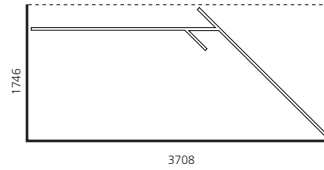
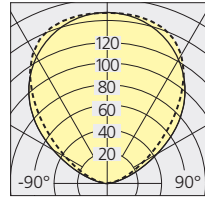

Kit D

T16 (G5)

W	Weight	Flux
2x54W	8,80Kg	8900 lm

Code
M119420

220/240Vac 50/60Hz electronic ballast included.

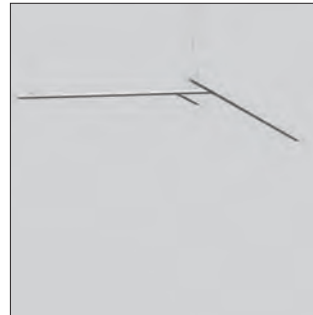

IP20 ⊕
850°

T16

Efficiency 34%	2x54 W	8900 lm
----------------	--------	---------

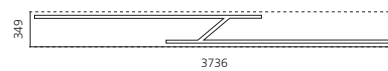
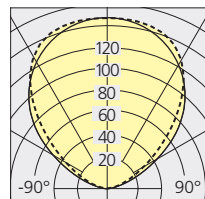

Kao wall/ceiling

○
White

Kit E

T16 (G5)

W	Weight	Flux
4x54W	16,00Kg	17800 lm

Code
M113020

220/240Vac 50/60Hz electronic ballast included.

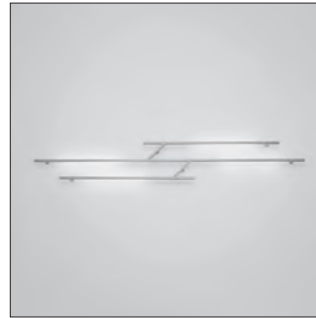

IP20 ⊕
850°

T16

Efficiency 34%	4x54 W	17800 lm
----------------	--------	----------

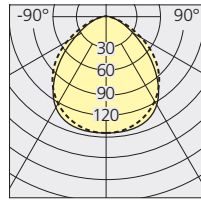

cd/klm
— C0 - C180
- - - C90 - C270

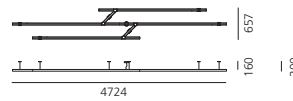

Kit F

T16 (G5)

W	Weight	Flux
3x54W + 2x24W	16,00Kg	13350 lm +3500 lm

Code
M113120

220/240Vac 50/60Hz electronic ballast included.



IP20 ⊕
850°

T16

Efficiency 34%	2x24 W 3x54 W	3500 lm 13350 lm
----------------	------------------	---------------------

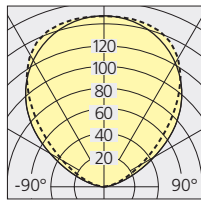

cd/klm
— C0 - C180
- - - C90 - C270

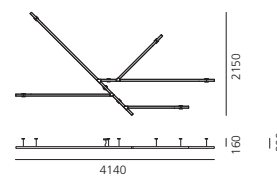

Kao wall/ceiling

○ White

Kit G

T16 (G5)

W	Weight	Flux
6x54W + 2x24W	25,70Kg	26700 lm +3500 lm

Code
M113220

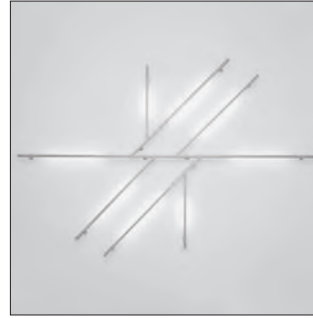

IP20 ⊕
850°

220/240Vac 50/60Hz electronic ballast included.

T16

Efficiency 34%

2x24 W	3500 lm
6x54 W	26700 lm

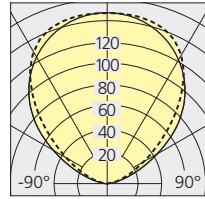

cd/klm
 — C0 - C180
 C90 - C270

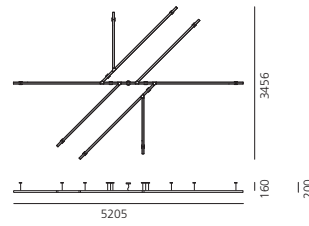



- Light fixture with fluorescent T5 light sources.
- Ceiling mounting.
- Consist of: body, diffuser, diffuser fixing bracket, ceiling plate.
- Body in injection mould of aluminium.
- Sand glass diffuser, 4mm-thick.
- Diffuser fixing bracket in aluminium.
- Ceiling mounting plate in aluminium.
- Integrated drivers.
- Fluorescent tubes not included.
- IP Rating IP65.
- Insulation class I.
- Technical features of light fixtures in compliance with EN60598-1.
- Installation must be carried out by specialized personnel.
- Carefully follow the instructions.

Tray

Silver



				Non dimmable	Dali
W	Weight	Source	Color	Code	Code
2 x 24W	4,50 kg	T16 (G5)	●	NL398002	NL398102
2 x 54W	7,70 kg	T16 (G5)	●	NL504002	NL504102
2 x 49W	8,60 kg	T16 (G5)	●	NL4591020	NL4591120

Suspension kit

NL132202

220/240Vac 50/60Hz electronic ballast.



IP65

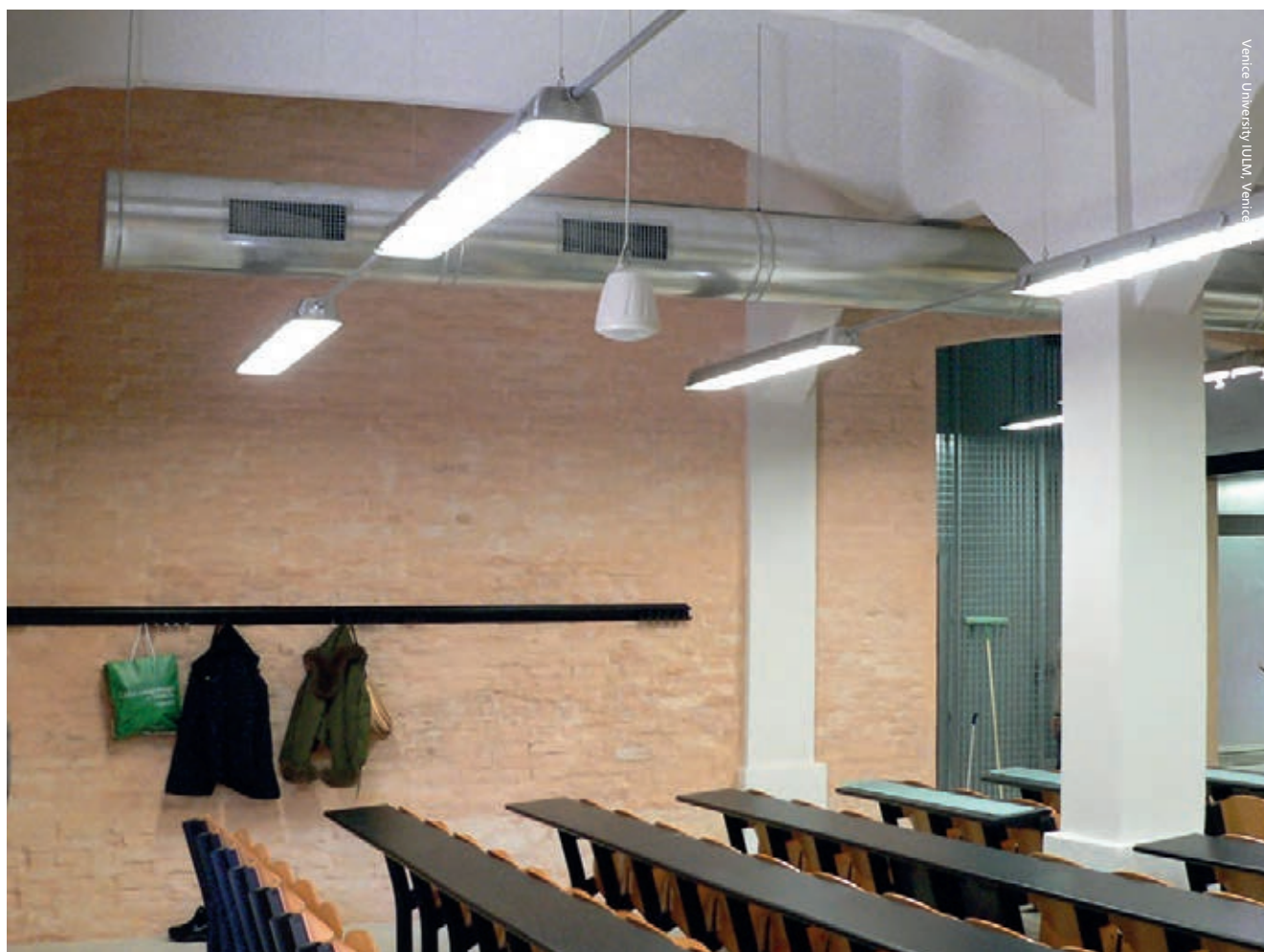
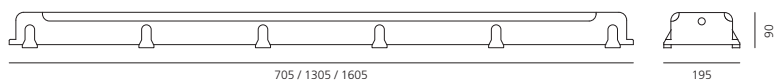

Venice University / UIM, Venice



Solar LED is a recessed light fitting producing a soft, high-output light. High efficiency and light quality are achieved by an innovative optical system based on the principles of a lighthouse. The 'lighthouse' optic directs all LED luminous flux to a bespoke, highly-reflective surface. The light is then redirected on to the luminaire body, which is finished in a highly-efficient diffusing paint. The result is a diffused, comfortable, soft light emission, with a highly efficient performance.

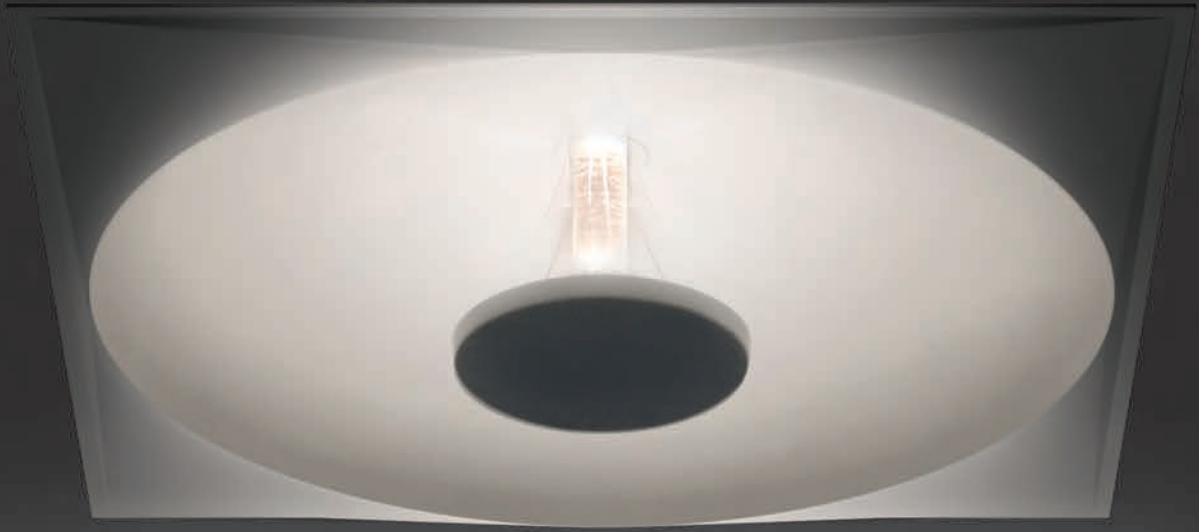





Solar LED



- Installation on modular false ceiling (600x600mm and 625x625mm) with visible supporting structure or, by means of a suspension kit, with concealed structure.
- Installation also possible in plasterboard ceiling by means of a recessing frame (available as accessory).
- Suspension kits and frames need to be ordered separately.
- Electronic power supply, or dimmable electronic power supply.
- Compliant with the standard EU60598-1 and other specific regulations.

Solar LED

Glossy white
○

W	Weight	Ceiling	Flux	CCT	Color
49 W	5,46 kg	600x600 mm	2538 lm	3000 K	○
			2670 lm	4000 K	○
	5,50 kg	625x625 mm	2538 lm	3000 K	○
			2670 lm	4000 K	○

Non dimmable
Code
M033500
M033600
M033700
M033800

Dali-SwitchDim
Code
M033501
M033601
M033701
M033801



220/240Vac 50/60Hz electronic ballast included.

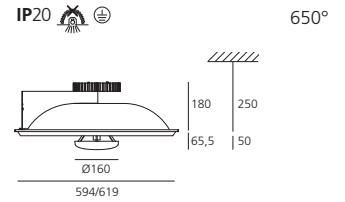

Solar LED	LED	luminaire	
Power	42 W 42 W	49 W	49 W
Flux	4200 lm 4450 lm	2538lm	2670 lm
CCT	3000 K 4000 K	3000 K	4000 K
CRI	=80 (min.)		
Color tolerance	MacAdam 3SDCM		
Service life	L70(6K) > 36000h		
Beam		52°	52°
Efficiency		60%	60%
Efficacy	100 lm/W 106 lm/W	52 lm/W	54 lm/W

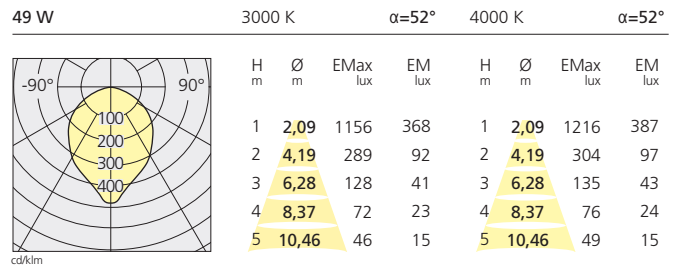

Accessories

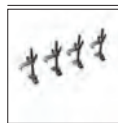

Suspension kits (4 pieces)
To be used when the false ceiling is accessed from above.

Code
M163520



Frame for installation on plaster false ceiling
600x600 mm □ 606x606 mm
0,90 Kg

M160600

Frame for installation on plaster false ceiling
625x625 mm □ 633x633 mm
0,94 Kg

M160602

Solar LED

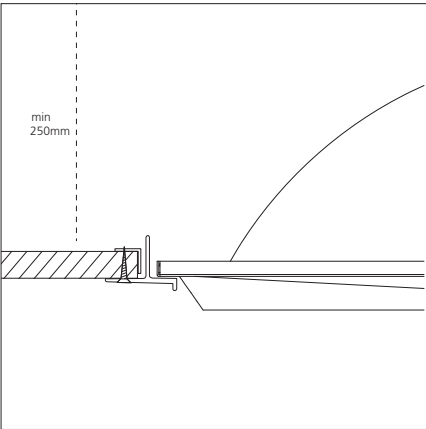
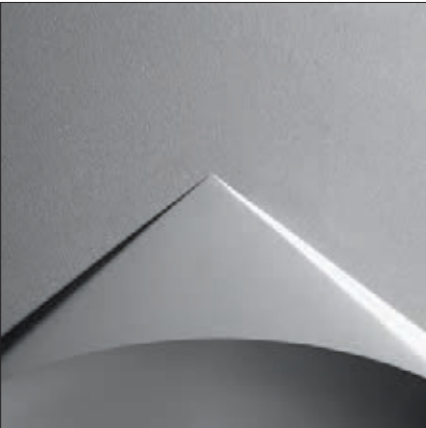

Installation on plasterboard false ceiling through recess frame. (M160600 or M160602), available as accessories.

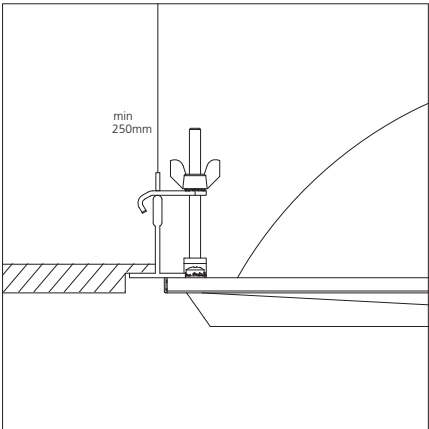

Installation on panel false ceilings 600x600 mm or 625x625 with appropriate brackets (M163520, to be ordered separately), on a recessed structure.

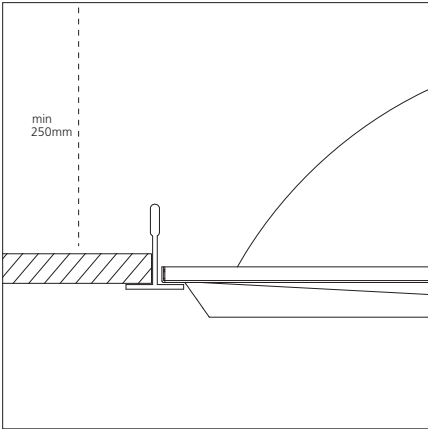

Installation on panel false ceiling 600x600 mm or 625x625 mm with exposed supporting framework.



Bolero

Studio Artemide
2007

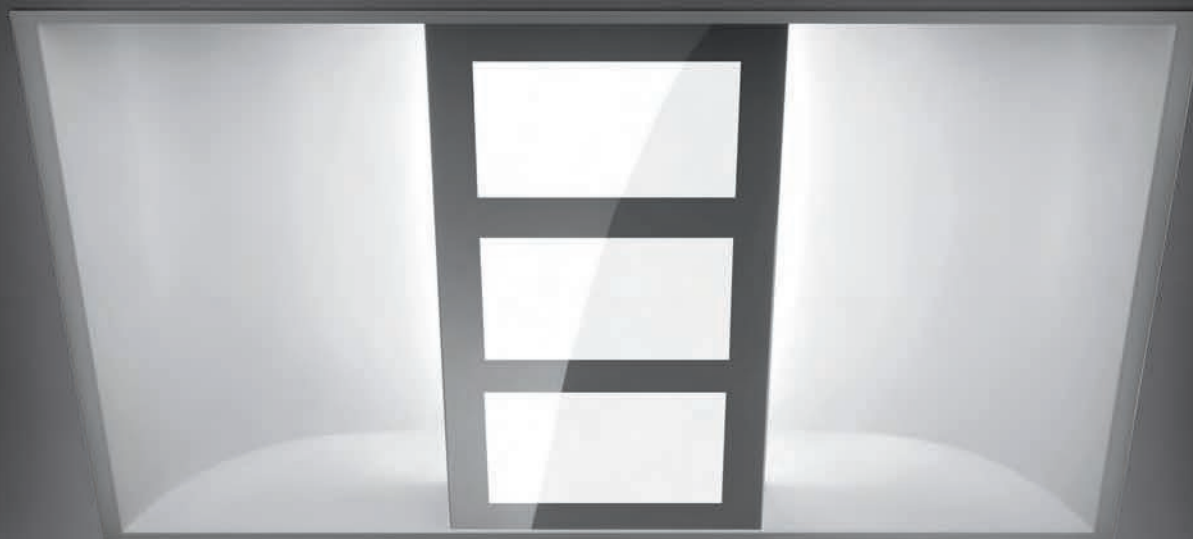

- Recessed luminaire using 2x55w TC-LEL fluorescent lamps.
- Main reflector in steel with a white paint finish.
- Polished aluminium screen equipped with a prismoptic polycarbonate diffuser.
- For installation into false ceiling systems with 600x600mm and 625x625mm modules, or into plasterboard false ceilings using a special recessing frame (optional).
- Lamps can be serviced without the need for tools.
- Electronic or Dali-SwitchDim dimmable electronic ballast.
Optional emergency lighting.
- Complies with standard EN60598-1 and other specific standards.

Bolero

White



TC-LEL (2G11)

W	Weight	Ceiling	Flux	Color
2x55 W	6,90Kg	600x600 mm	9600 lm	○
	7,30Kg	625x625 mm	9600 lm	○

Non dimmable

Code
M162400
M162402

+ emergency 1h

Code
M162407

Dali-SwitchDim

Color	Code
○	M162401
○	M162421



220/240Vac 50/60Hz electronic ballast included

IP20

850°

TC-LEL

Efficiency 30%	2x55W	9600 lm
----------------	-------	---------

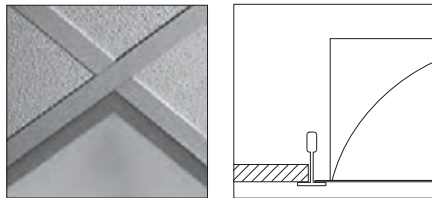
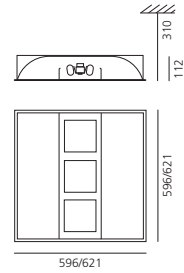
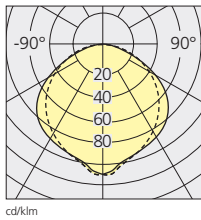

Installation with luminaire incorporated into the 600/625 modular ceiling structure.

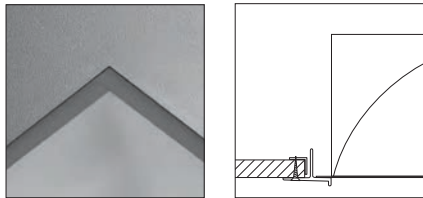

Installation into plaster ceiling with optional recess frame (M160600 or M160602).

Accessories



Recess frame for installation into plaster false ceiling
600x600mm 606x606mm
0,90 kg

Code
M160600



Recess frame for installation into plaster false ceiling
625x625mm 633x633mm
0,94 kg

M160602

Kalifa recessed

Ernesto Gismondi
2005

- A range of recessed luminaires using fluorescent lamps, available in 2 versions: soft light (2x55w TC-LEL), and combined emission dark light + diffuser (4x24 W T16).
- Suitable for installation into false ceiling systems with 600x600mm and 625x625mm modules, or into plasterboard false ceilings using a special recessing frame (optional).
- Electronic or dali-switchdim dimmable electronic ballast, or emergency lighting.
- Complies with standard EN60598-1 and other specific standards.

Soft light

- Steel main reflector, with white paint finish. 4mm thick screen-printed tempered glass.

Dark light + Diffuser

- Body in galvanized steel. 4mm thick screen-printed tempered diffusing glass. Dark light optics.

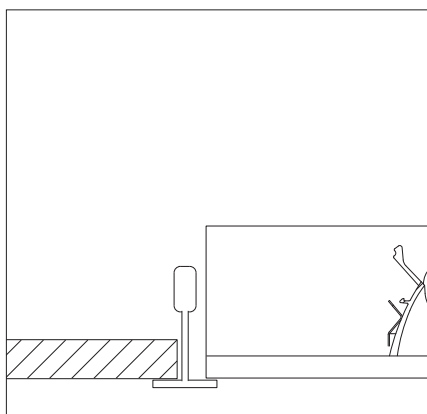
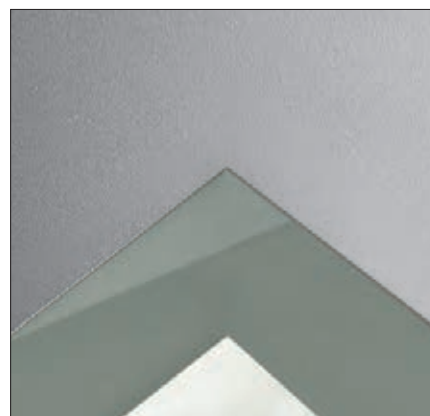

Installation with luminaire incorporated into the 600/625 modular ceiling structure.

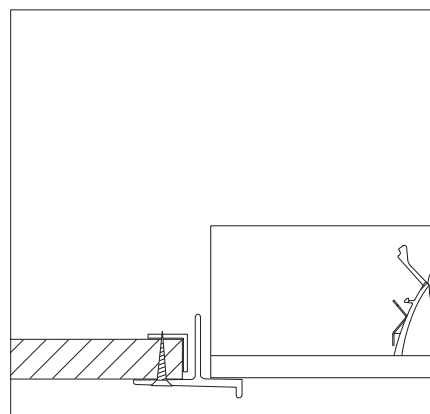

Installation into plaster ceiling with optional recess frame (M160600 or M160602).



Kalifa recessed soft light

White



TC-LEL (2G11)

W	Weight	Ceiling	Flux	Color
2x55 W	9,90 kg	600x600 mm	9600 lm	○
	10,30 kg	625x625 mm	9600 lm	○

Non dimmable

Code
M160400
M160402

+ emergency 1h

Code
M160407

Dali-SwitchDim

Color	Code
○	M160401
○	M160421



220/240Vac 50/60Hz electronic ballast included

IP40/IK10(20j) Ⓧ

850°

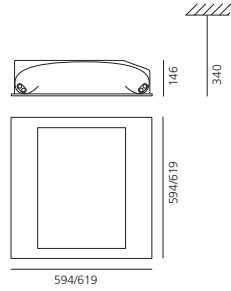

TC-LEL

Efficiency 34%	2x55 W	9600 lm
----------------	--------	---------

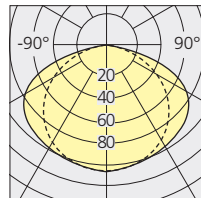

cd/kim
 - - - C0 - C180
 ····· C90 - C270

Components



Recess frame for installation on plasterboard false ceiling.
 600x600mm □ 606x606mm
 0,90kg

Code
M160600

Recess frame for installation on plasterboard false ceiling.
 625x625mm □ 633x633mm
 0,94kg

M160602

Kalifa recessed dark light + diffuser

White
○

T16 (G5)

W	Weight	Ceiling	Flux	Color
4x24 W	9,20 kg	600x600 mm	7000 lm	○
	9,60 kg	625x625 mm	7000 lm	○

Non dimmable

Code
M160700
M160702

+ emergency 1h

Code
M160707



IP40/IK10(20j) ☹ 850°

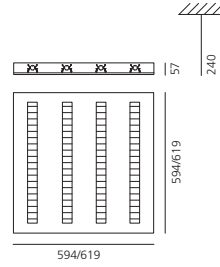

T16 (G5)

W	Weight	Ceiling	Flux	Color
4x14 W	9,20 kg	600x600 mm	7000 lm	○
4x24 W	9,20 kg	600x600 mm	7000 lm	○
4x14 W	9,60 kg	625x625 mm	7000 lm	○
4x24 W	9,60 kg	625x625 mm	7000 lm	○

Dali-SwitchDim

Code
M160701
M160701
M160721
M160721

220/240Vac 50/60Hz electronic ballast included
Kalifa Recessed light fittings M160701 and M160721 are supplied with 2 power supplies, therefore they occupy 2 DALI addresses.

T16

Efficiency 37%	4x14 W	7000 lm
	4x24 W	7000 lm

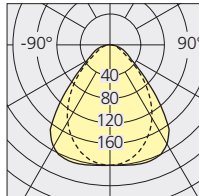

cd/klm
..... C0 - C180
..... C90 - C270

Components



Recess frame for installation on plasterboard false ceiling.
600x600mm □ 606x606mm
0,90kg

Code

M160600

Recess frame for installation on plasterboard false ceiling.
625x625mm □ 633x633mm
0,94kg

M160602



- Light fixture with high-performance LED light sources.
- Wall or ceiling installation.
- Consists of: body, polycarbonate screen, plate for emergency battery pack.
- Body in aluminium.
- Polycarbonate screen, 8mm-thick, with customizable serigraphy.
- Plate for battery pack in aluminium (emergency version only).
- Integrated driver.
- Can operate in signaling mode or emergency mode (always on or emergency only).
- Integrated emergency: battery pack, 3-hours duration (emergency version).
- IP Rating IP40.
- Insulation class I.
- Technical features of light fixtures in compliance with EN60598-1.
- Installation must be carried out by specialized personnel.
- Carefully follow the instructions.

Leb incasso

		Emergency	Signalling
W Weight	CCT	Code	Code
2 W 0,70 kg	5000K	NL3200050W0	NL3200150W0
Middle arrow		NL32010	
Lift/right arrow		NL32011	

220/240Vac 50/60Hz electronic ballast included.

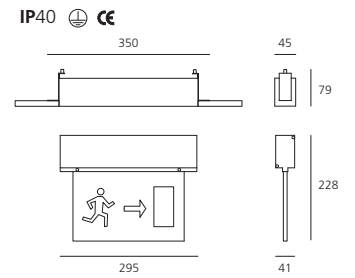

Leb soffitto

		Emergency	Signalling
W Weight	CCT	Code	Code
2 W 0,70 kg	5000K	NL3200250W0	NL3200350W0
Middle arrow		NL32010	
Lift/right arrow		NL32011	

220/240Vac 50/60Hz electronic ballast included.

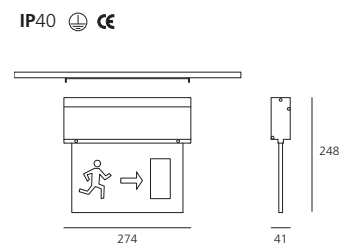

Leb parete

		Emergency	Signalling
W Weight	CCT	Code	Code
2 W 0,70 kg	5000K	NL3200450W0	NL3200550W0
Middle arrow		NL32010	
Lift/right arrow		NL32011	

220/240Vac 50/60Hz electronic ballast included.



IP40

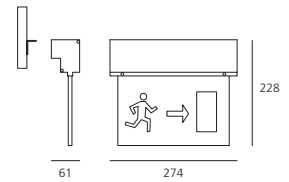

Leb bandiera

		Emergency	Signalling
W Weight	CCT	Code	Code
2 W 0,70 kg	5000K	NL3200650W0	NL3200750W0
Middle arrow		NL32010	
Lift/right arrow		NL32011	

220/240Vac 50/60Hz electronic ballast included.



IP40

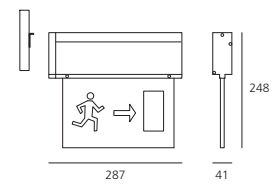



Examples of possible customisation of the screen

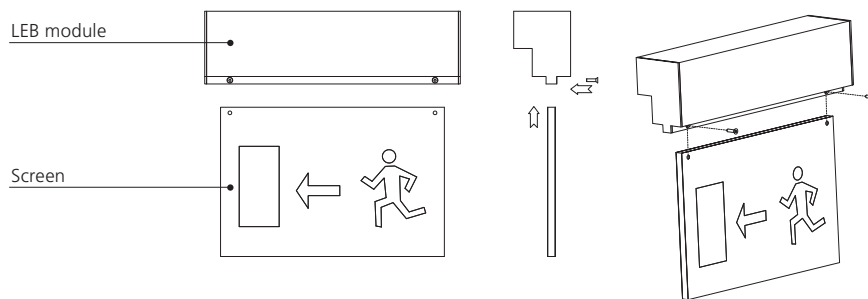

- Light fixture with LED light sources.
- Ceiling or wall installation.
- Monochromatic light and/or RGB.
- Wall or ceiling mounting.
- Consists of electronic circuit board, electrical cable, LED, (optional) mounting element.
- Electronic circuit board or driver for powering, integrated in a plastic box (included)
- Electrical cable type Li-YY two-pole or FROR 4-poles.
- Mounting elements in plastic or chrome-brass (to be ordered separately)
- White monochromatic LEDs available in 2 colour temperatures:
Warm = 2900K
Neutral = 4500K
- Monochromatic LED also available in the colours Red, Green and Blue.
- Full colour RGB LED.
- Insulation class:
Monochrome version I.
RGB version III.
- Technical features of light fixtures in compliance with EN60598-1.
- Installation must be carried out by specialized personnel.
- Carefully follow the instructions.



Starled

Starled L. 1000 mm

W LED	Weight	Beam	CCT	Code	
0,2 W	0,3 kg	20°	2900 K	NL729920K0	
			4500 K	NL729920T0	
			2900 K	NL730050K0	
			4500 K	NL730050T0	
		50°	2900 K	BLU	NL730130B0
				RED	NL730330R0
				GREEN	NL730230G0
				2900 K	NL730050K0
		30°	2900 K	BLU	NL730930B0
				RED	NL731130R0
				GREEN	NL731030G0
				2900 K	NL730720K0

Electronic ballast supplied separately

Starled L. 2000mm

W LED	Weight	Beam	CCT	Code	
0,2 W	0,5 kg	20°	2900 K	NL730720K0	
			4500 K	NL730720W0	
			2900 K	NL730850K0	
			4500 K	NL730850W0	
		50°	2900 K	BLU	NL730930B0
				RED	NL731130R0
				GREEN	NL731030G0
				2900 K	NL730720K0
		30°	2900 K	BLU	NL730930B0
				RED	NL731130R0
				GREEN	NL731030G0
				2900 K	NL730720K0

Electronic ballast supplied separately

Driver	Vac	n° devices	Code
Starled master unit 240 x 190 x 90mm	230Vac	2-50 led max	NL72970
Starled slave unit 240 x 190 x 90mm	12Vac	2-50 led max	NL72980

		Code
Plastic body	13,5ø x 14 mm	NL73130
Chrome body	24ø x 22 mm	NL73140



IP20

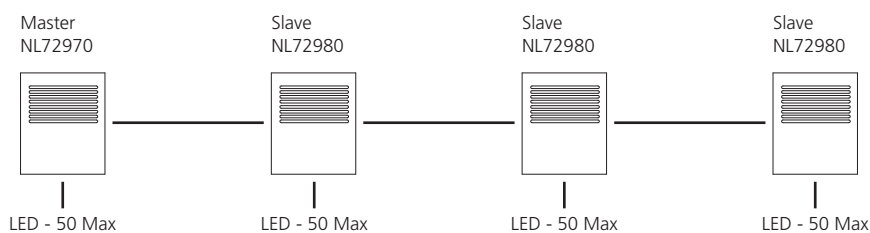

Starled RGB

Starled RGB L. 2000 mm

Power LED	Weight	Beam	CCT	Code
1,44 W	0,05 Kg/m	30°	RGB	NL75210

Electronic ballast 24Vdc SELV supplied separately

Driver	Vac	n°device	Code
Starled RGB Master Unit 190X140X70mm	230Vac	2-30 led max	NL75200

Driver	Vac	Vout (Vdc)	n°LED max.	Code	
LED driver NLX 2-50	50W	230	24Vdc	30	NL19050
LED driver NLX 2-75	75W	230	24Vdc	50	NL75190
LED driver NLX 2-100	100W	230	24Vdc	65	NL82030
LED driver NLX 2-150	150W	230	24Vdc	100	NL80220

	Code
DSC 30 USB interface DMX stand alone	NL19030
9V/350mA ballast with mini USB connector for DSC30	NL19031
50cm cable with HE10 connector for keyboard (optional)	NL7833

	Code
Plastic body	NL73130
Chrome body	NL73140



IP20

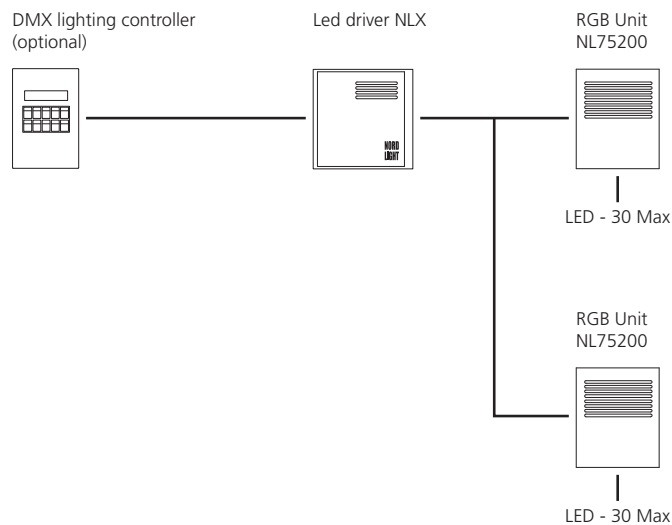

- The Pixel Mesh is a matrix of RGB LED that can be controlled to create any kind of signage, image, or scenario according to the request of the client.
- The Pixel Mesh can be used indoors and outdoors, and several basic modules can be combined to extend the system to the desired area.
- The basic module has a density of 1024 LED/sqm (pitch 30mm), with a total power of 280W/sqm.
- The control system is integrated in the product and can be re-programmed even after installation.
- Transparency factor 55%.
- Flexible module.
- Plug-&-play installation.



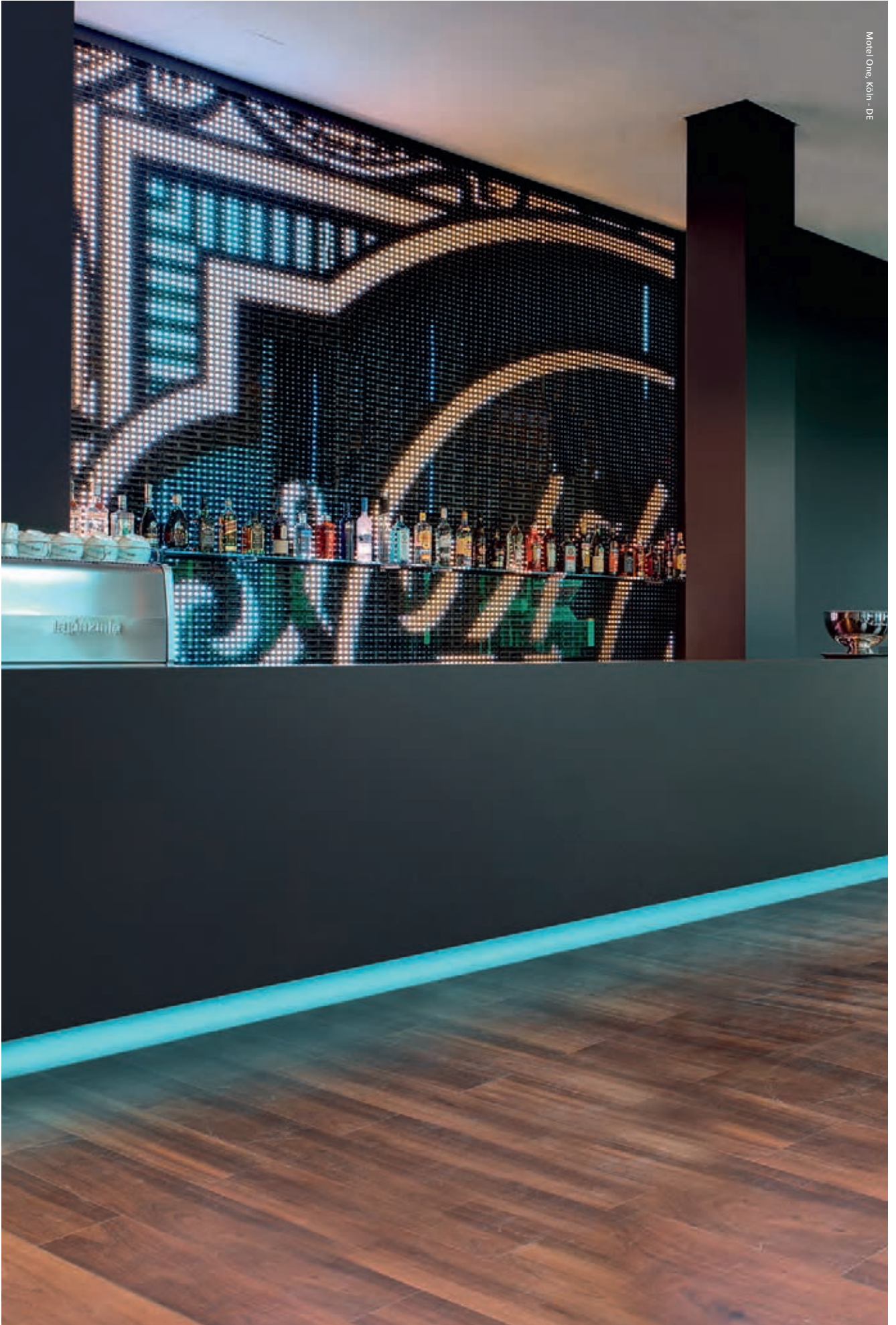

Pixel Mesh

Single module

	W LED	Weight		Area
LED 3 in 1 SMD	70W	1,90 kg	RGB	0,25 m ²
Resolution 31,25				
Transparency 55%				
Refresh rate 2000Hz				
Input frequency 50-60Hz				
Data connection RJ45				
Tested in environments with temperature from -20°C to +50°C				
IP63				

220/240Vac 50/60Hz main voltage

Pixel mesh needs to be permanently connected to a PC with DVI output to play video and images of any given digital format.

The product can be customized to respond to different project needs. For dedicated quotation and further enquiries, please contact Artemide sales office.

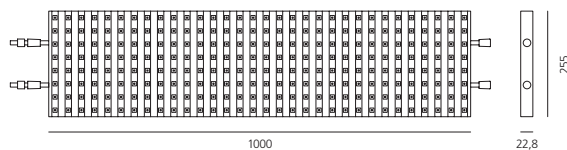

A.

Outdoor



Scenographic Lighting	616	Diamante
	620	Spike
	628	Superspike
	632	LineaLed
	644	Label Light
	648	Riga
	652	Dedalo



Diamante

Charles Keller, Daniel Marques,
Adrian Schiess
2009

- The Diamante is a light element that can create light scenes of great visual impact, due to the availability of "diamonds" of different colors or by means of the use of prismatic filters.
- The vertical drop can be realized with different configurations of the number of "diamonds" and heights. The (optional) dynamic light control gives the installation a magical and moving character.
- Each Diamante consists of a double-faced LED circuit board and a prism in injection mould of ABS, connected by means of a special electrical cable with high resistance and lightness which allows the flow of data control and electrical current.
- Specific mounting and connection devices give appropriate ease for mounting and maintenance of the system.





Diamante

	W LED	Weight	Colour
Body in injection mould of ABS	1,75W	0,80 kg	Cascade 7 "diamanti" transparent
Electrical cable with high resistance to wind			Cascade 7 "diamanti" transparent and colour
IP68 electrical connectors			Cascade 7 "diamanti" multicolour
Mechanical joints and hooks in stainless steel			
12Vdc electronic ballast			

The product can be customized to respond to different project needs. For dedicated quotation and further enquiries, please contact Artemide sales office.



IP65

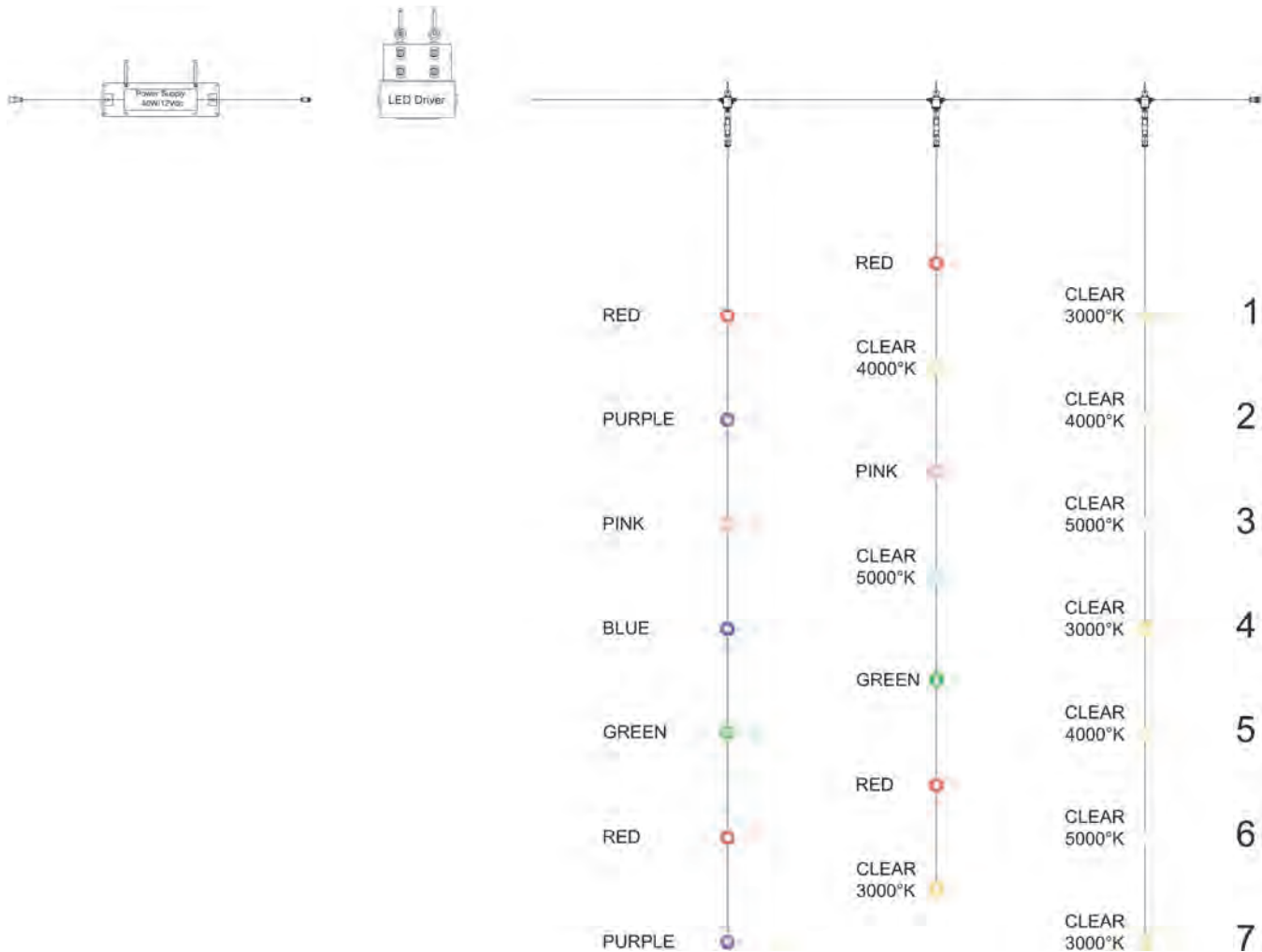
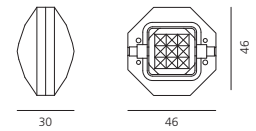





- Lighting appliance with high-yield LED sources.
- Wall or ceiling mounted.
- Monochrome or RGB light.
- EN AW6060 T5 extruded aluminium body.
- 3mm-thick methacrylate diffuser.
- EN AB 47100 die-cast aluminium caps with silicon rim.
- Aluminium adjustment brackets.
- Power unit connection with bipolar H05RN-F cable (monochrome) or quadripolar silicon/rubber cable (RGB), with standard IP 68 clamp*.
- Remote 24 Vdc power unit.
- Painted die-cast aluminium with 3-stage outdoor treatment: nanotechnologies, anti-oxidant primer, polyester paint.
- Optional painted extruded aluminium anti-glare screen.
- Optical units. PMMA lenses with 3 different beam options.
- White monochrome LEDs available in 2 colour temperatures:
Warm = 3000K
Neutral = 4000K.
- RGB version made up of monochrome red, green, and blue LEDs.
- Protection rating IP65.
- Electrical insulation class III.
- Technical specifications of EN60598-1 compliant appliances.
- Mounting should be entrusted to specialized technicians.
- Follow instructions closely.

Spike

Spot optic

Concentrated luminous flow to highlight details avoiding unwanted light dispersion.

spot optic



Medium optic

Medium luminous flux to highlight details, large sections of windows.

flood optic

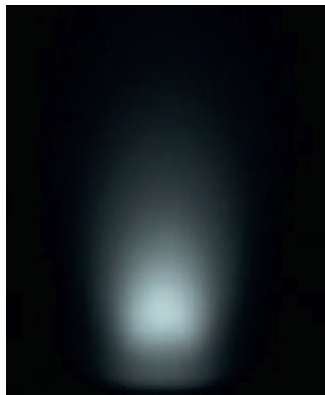

Wallwasher optic

Elliptical distribution of the luminous flow suitable for wallwasher effect.

elliptic optic

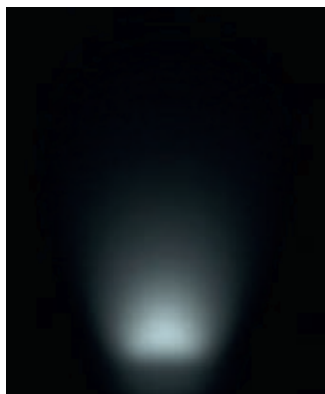



W	Length	Beam	Efficacy	Flux	CCT	Code
12 W	264	12°	50 lm/W	593 lm	3000K	T430010W00
			51 lm/W	611 lm	4000K	T430010N00
		28°	46 lm/W	554 lm	3000K	T430025W00
			48 lm/W	571 lm	4000K	T430025N00
		12°x34°	50 lm/W	593 lm	3000K	T4300ELW00
			51 lm/W	611 lm	4000K	T4300ELN00
24 W	486	12°	50 lm/W	1185 lm	3000K	T430110W00
			51 lm/W	1221 lm	4000K	T430110N00
		28°	46 lm/W	1107lm	3000K	T430125W00
			48 lm/W	1441 lm	4000K	T430125N00
		12°x34°	50 lm/W	1187 lm	3000K	T4301ELW00
			51 lm/W	1223 lm	4000K	T4301ELN00
36 W	726	12°	50 lm/W	1782 lm	3000K	T430210W00
			51 lm/W	1836 lm	4000K	T430210N00
		28°	46 lm/W	1661 lm	3000K	T430225W00
			48 lm/W	1712 lm	4000K	T430225N00
		12°x34°	50 lm/W	1780 lm	3000K	T4302ELW00
			51lm/W	1834 lm	4000K	T4302ELN00
48 W	966	12°	50 lm/W	2376 lm	3000K	T430310W00
			51 lm/W	2448 lm	4000K	T430310N00
		28°	46 lm/W	2215 lm	3000K	T430325W00
			48 lm/W	2283 lm	4000K	T430325N00
		12°x34°	50 lm/W	2374 lm	3000K	T4303ELW00
			51 lm/W	2448 lm	4000K	T4303ELN00

CRI =80 (min)

24Vdc power supplied separately

	12W	24W	36W	48W			
Driver 40W	24 Vdc	IP67	3	1	1	NL62040	
Driver 70W	24 Vdc	IP67	5	2	1	NL89080	
Driver 150W	24 Vdc	IP67	12	6	4	3	NL62880

Components needed for dimming are available upon request.

Antidazzle screen	247mm	T430801
	469mm	T430802
	709mm	T430803
	946mm	T430804

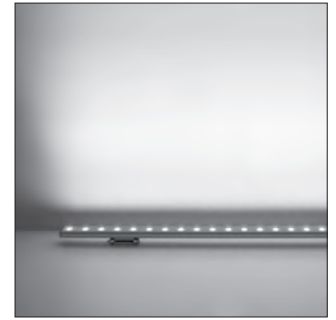

IP65

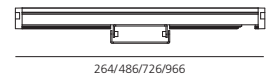

264/486/726/966



ø 35

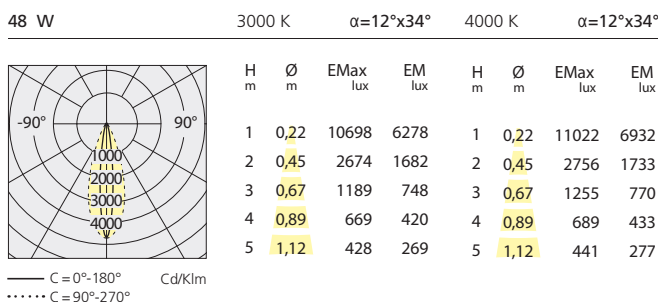
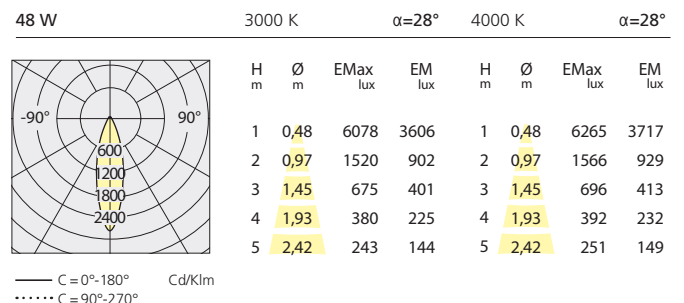
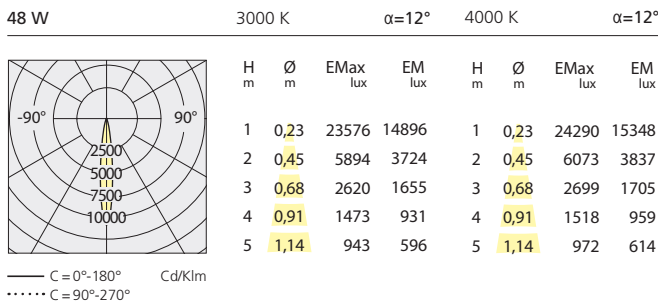

Spike RGB

Silver grey



W		Beam	Color
25 W RGB	L=780mm	10°	●
		25°	●
		14°x34°	●
		40°	●

Code
NL5003110C002
NL5003130C002
NL50031ELC002
NL5003140C002

LED driver NLX 2-70 IP65 70W 24Vdc	PWM	2 max
LED driver NLX 2-100 IP65 100W 24Vdc	PWM	3 max
LED driver NLX 2-150 IP65 150W 24Vdc	PWM	5 max

NL81260
NL84100
NL77270

PWM driver for fixtures with autonomous colour programme for stand-alone or controlled working by means of DMX 512 protocol for installations of all sizes.

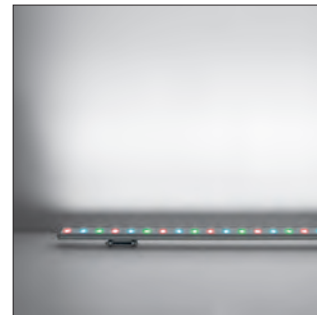

IP65 16,7 M

DSC 30 USB interfaced DMX stand alone

NL19030

Digital interface provided with software. If connected to the PC USB port, it transforms the programme instructions into DMX 512 control signals. DSC30 (512 DMX controllable channels, real-time clock, local use) allows computer-interactive programming and stand-alone mode, that is the possibility of autonomous interface repetition without PC connection.

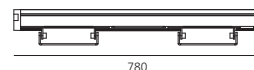

9V/350mA ballast with mini USB connector for DSC30
 50cm-long Cable with HE10 connector for connection to a keyboardm
 Antidazzle screen

NL19031
 NL7833
 NL50035



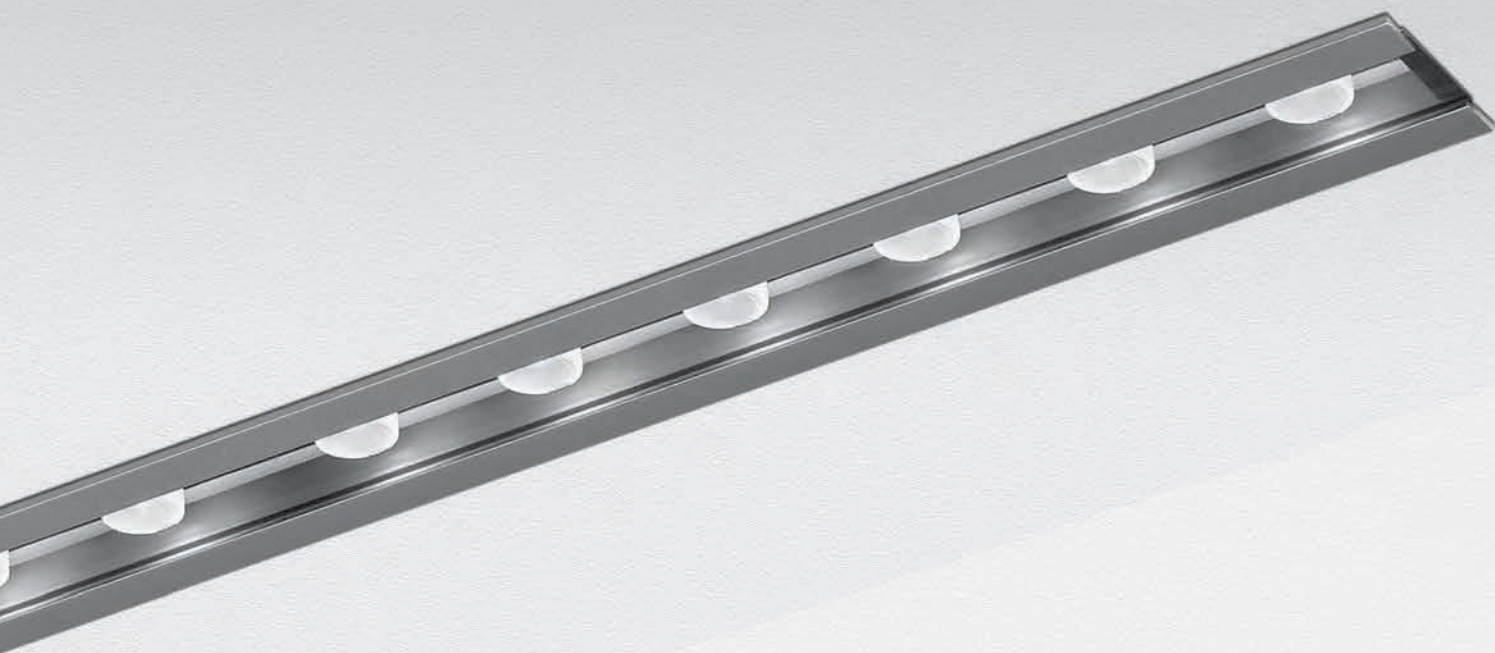

- Light fixture with high-performance LED light sources.
- Ceiling installation.
- Body in extruded EN AW6060 T5 aluminium.
- Diffuser in transparent polycarbonate, 1,5mm-thick.
- Stoppers in transparent polycarbonate.
- Fixing springs in harmonic steel.
- Electrical connection to the ballast by means of 2-pole FEP cable (monochromatic version) or 4-pole FEP cable (RGB version), with appropriate terminal board supplied with the fixture.
- 24Vdc remote ballast.
- Optics. PMMA lenses in 3 different versions of beams.
- White monochromatic LEDs available in 2 colour temperatures:
Warm = 3000K
Neutral = 4000K
- RGB version with red, green and blue monochromatic LEDs.
- IP Rating IP40.
- Insulation class III.
- Technical features of light fixtures in compliance with EN60598-1.
- Installation must be carried out by specialized personnel.
- Carefully follow the instructions.

Spike Incasso

CRI = 80(min)

W	L	Weight	Beam	Flux	CCT	Code
17 W	500	0,80kg	10°	888 lm	3000K	NL1707110K0
				960 lm	4000K	NL1707110W0
			25°	888 lm	3000K	NL1707125K0
				960 lm	4000K	NL1707125W0
			14°x34°	888 lm	3000K	NL17071ELK0
				960 lm	4000K	NL17071ELW0
34 W	1000	1,30kg	10°	888 lm	3000K	NL1707210K0
				960 lm	4000K	NL1707210W0
			25°	888 lm	3000K	NL1707225K0
				960 lm	4000K	NL1707225W0
			14°x34°	888 lm	3000K	NL17072ELK0
				960 lm	4000K	NL17072ELW0

Electronic ballast 24Vdc SELV supplied separately.

			17W	34W	Code
Driver	19 W	24Vdc	1max		NL19040
Driver	70 W	24Vdc	4max	2max	NL8711

Dimmable fixture, dimming devices available upon request.

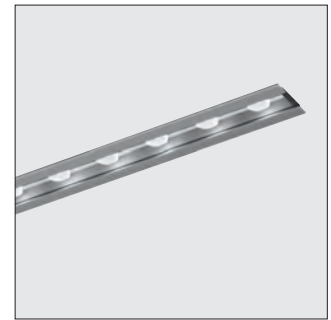

IP40

L x 39

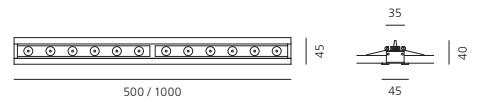

17 W 4000 K α=10°

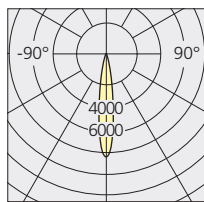

cd/klm

H m	Ø m	EMax lux	EM lux
1	0,28	6716	4289
2	0,55	1679	1072
3	0,83	746	477
4	1,10	420	268
5	1,38	269	172

17 W 4000 K α=25°

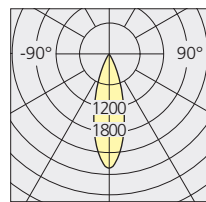

cd/klm

H m	Ø m	EMax lux	EM lux
1	0,54	2169	1308
2	1,09	542	327
3	1,63	241	145
4	2,18	136	82
5	2,72	87	52

17 W 4000 K α=14°x34°

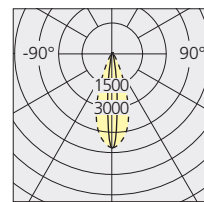

cd/klm

H m	Ø m	EMax lux	EM lux
1	0,65	4803	3054
2	1,31	1201	736
3	1,96	534	339
4	2,62	300	191
5	3,27	192	122

RGB

W	L	Weight	RGB	Beam	Code
25W	800	1,00kg	16,7m	10°	NL1707510C
				25°	NL1707525C
				14°x34°	NL17075ELC

Driver	NLX 2-50	50 W	24Vdc	PWM	1 max	NL19050
Driver	NLX 2-75	75 W	24Vdc	PWM	2 max	NL75190
Driver	NLX 2-100	100 W	24Vdc	PWM	3 max	NL82030
Driver	NLX 2-150	150 W	24Vdc	PWM	5 max	NL80220

Electronic ballast 24Vdc SELV supplied separately.

DSC 30 USB interface DMX stand alone
 9V/350mA ballast with mini USB connector for DSC30
 50cm cable with HE10 connector for keyboard
 (optional)

NL19030
NL19031
NL7833

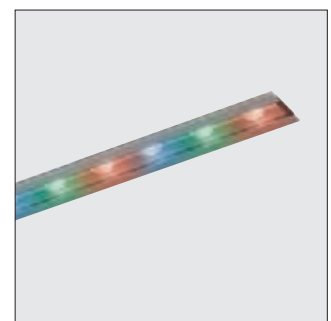

IP40

L x 39

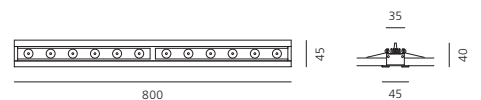



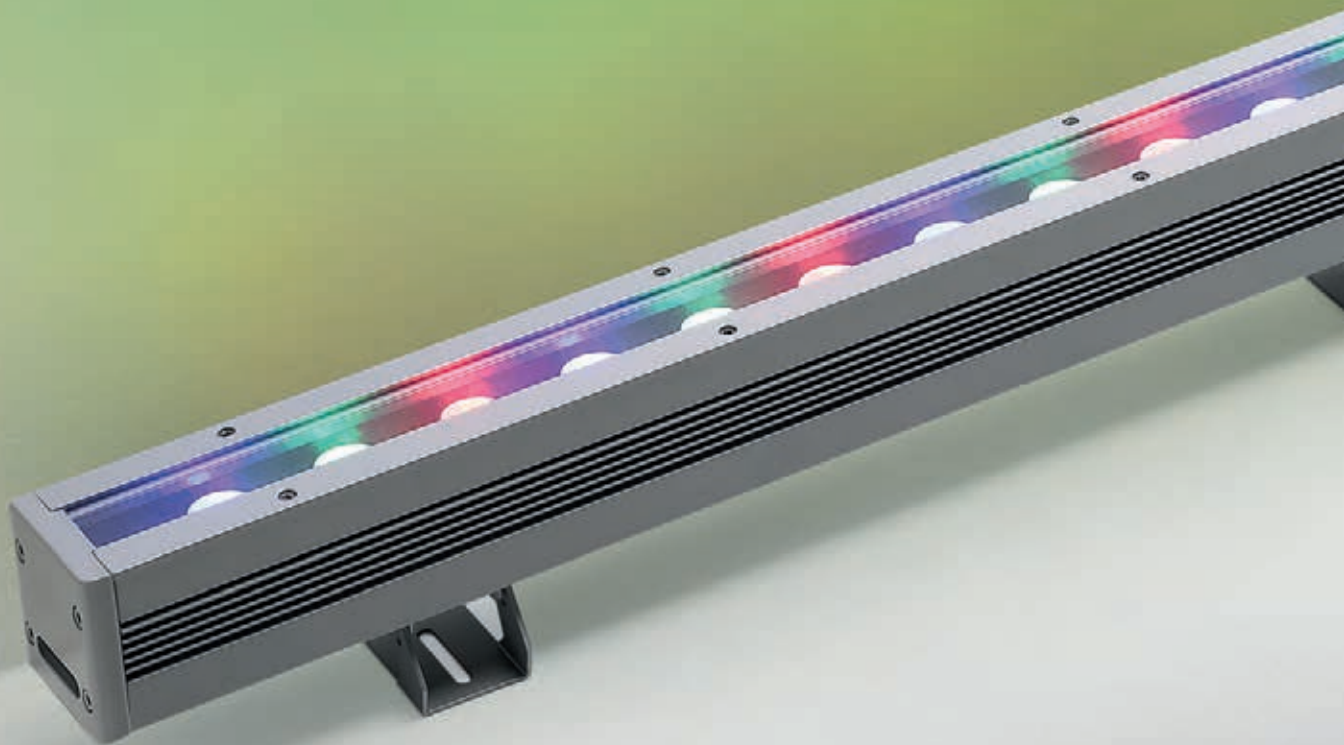

- Lighting appliance with high-yield LED sources.
- Wall or ceiling mounted.
- Monochrome or RGB light.
- Made up of a body, a diffuser, and a protection frame.
- EN AW6060 T5 aluminium extrusion body.
- Clear anti-UV 8mm-thick polycarbonate diffuser.
- Die-cast aluminium caps with silicon gasket.
- Painted aluminium brackets.
- Connection with power unit via bipolar H07RN-F cable with standard IP68 clamp included.
- Remote 24Vdc power unit.
- Optics. PMMA lenses with 3 different beam versions.
- Monochrome white LEDs available in 2 colour temperatures:
Warm = 3000K
Neutral = 4000K
- RGB version made of monochrome red, green, and blue LEDs.
- Profile finished with 2-stage outdoor treatment: primer, outdoor paint.
- The technical specifications of the appliances comply with EN60598-1.
- Protection rating IP65.
- Electric insulation class III.

W	Length	Beam	CRI	Flux	Efficacy	CCT	Code
50 W	750 mm	10°	80	1650 lm	33 lm/W	3000K	NL716610K0
			75	2175 lm	43 lm/W	4000K	NL716610W0
		25°	80	1650 lm	33 lm/W	3000K	NL716625K0
			75	2175 lm	43 lm/W	4000K	NL716625W0
		40°	80	1650 lm	33 lm/W	3000K	NL716640K0
			75	2175 lm	43 lm/W	4000K	NL716640W0
67 W	975 mm	10°	80	2200 lm	33 lm/W	3000K	NL716710K0
			75	2900 lm	43 lm/W	4000K	NL716710W0
		25°	80	2200 lm	33 lm/W	3000K	NL716725K0
			75	2900 lm	43 lm/W	4000K	NL716725W0
		40°	80	2200 lm	33 lm/W	3000K	NL716740K0
			75	2900 lm	43 lm/W	4000K	NL716740W0



IP65

	Super Spike 750	Super Spike 975	Code
Driver 19 W	24Vdc	1	NL89080
Driver 70 W	24Vdc	2	NL62880

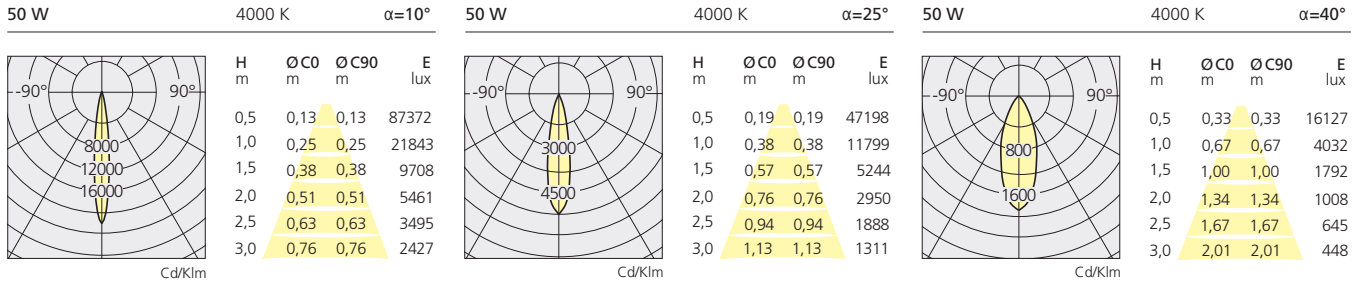
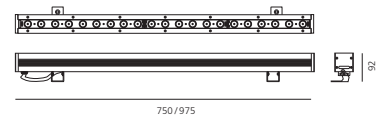

Superspike RGB

W	Length	Beam	Code
50W	750 mm	10°	NL756510C0
		25°	NL756525C0
		40°	NL756540C0
100W	1450 mm	10°	NL756610C0
		25°	NL756625C0
		40°	NL756640C0

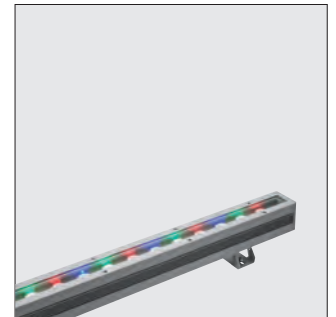

IP65 16,7 M

	Super Spike 750	Super Spike 975
LED driver NLX 2-70 IP65 70W 24Vdc	PWM 1	NL81260
LED driver NLX 2-100 IP65 100W 24Vdc	PWM 1	NL84100

PWM driver for fixtures with autonomous colour programme for stand-alone or controlled working by means of DMX 512 protocol for installations of all sizes.

DSC 30 USB interfaced DMX stand alone NL19030

Digital interface provided with software. If connected to the PC USB port, it transforms the program instructions into DMX 512 control signals. DSC30 (512 DMX controllable channels, real-time clock, local use) allows computer-interactive programming and stand-alone mode, that is the possibility of autonomous interface repetition without PC connection.

9V/350mA ballast with mini USB connector for DSC30 NL19031
 50cm-long Cable with HE10 connector for connection to a keyboard NL7833

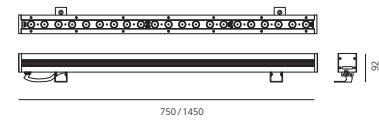

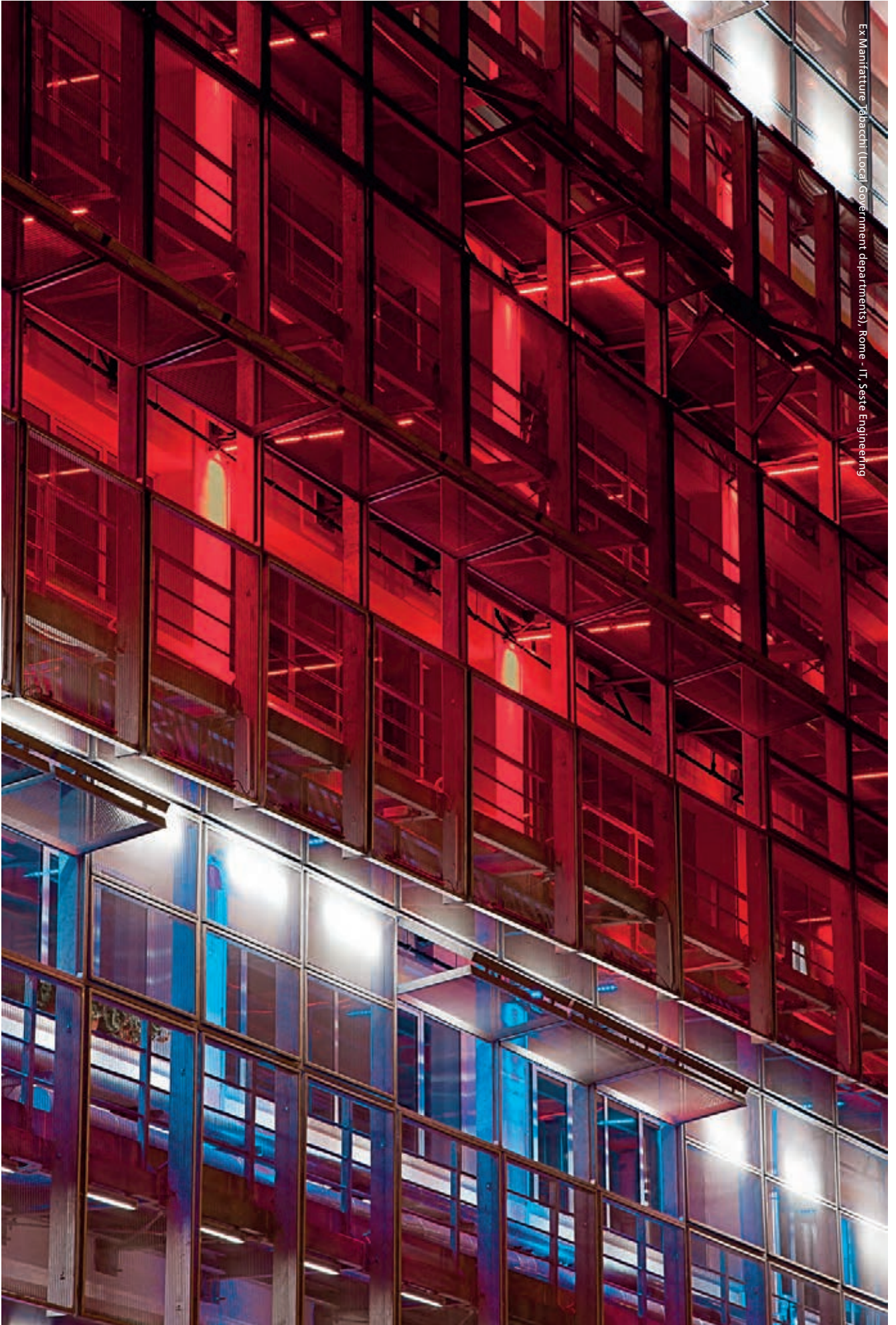

LineaLed Drive-over

Carlotta de Bevilacqua
2010

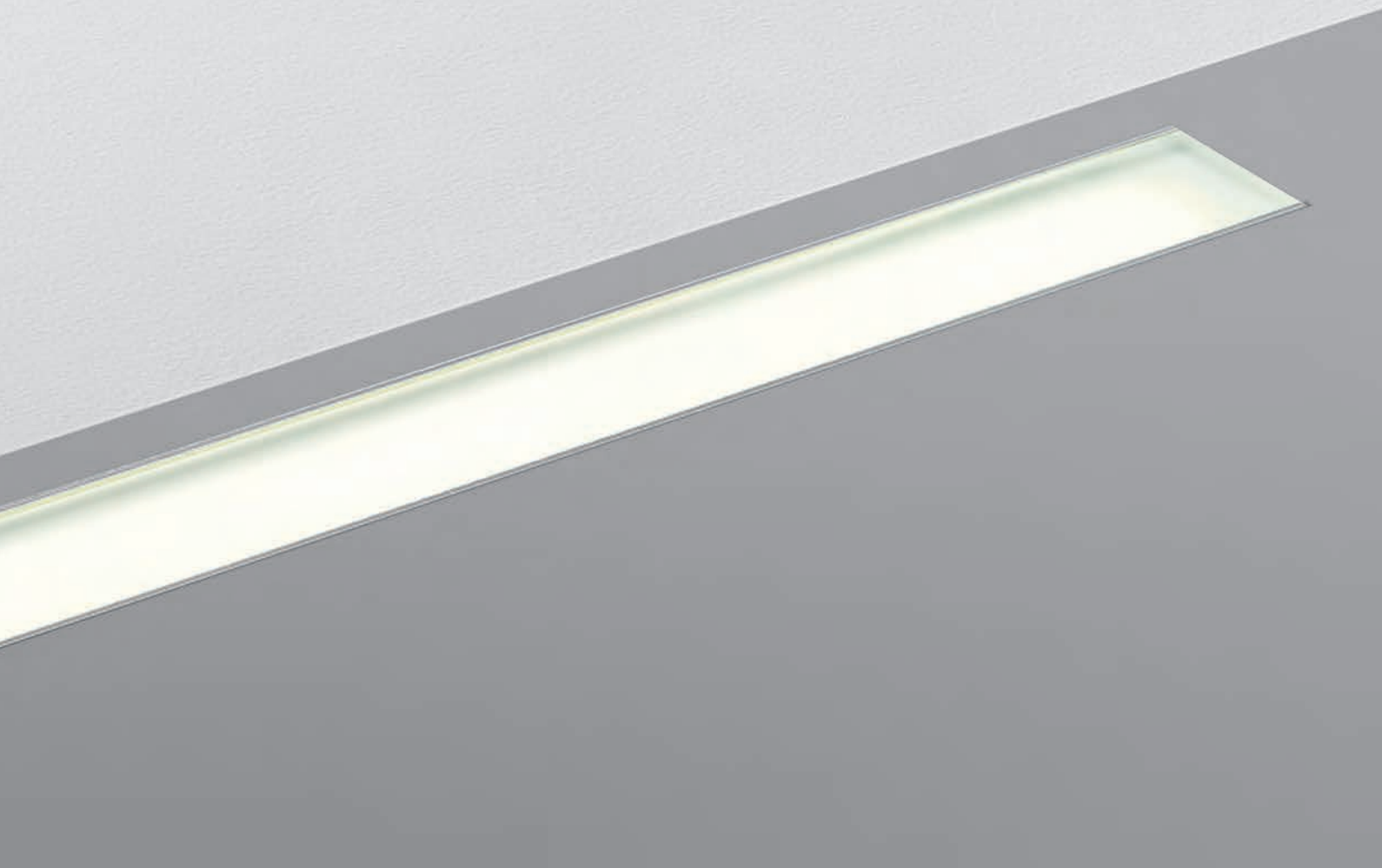

Walk over and drive over approved up to 5000Kg.

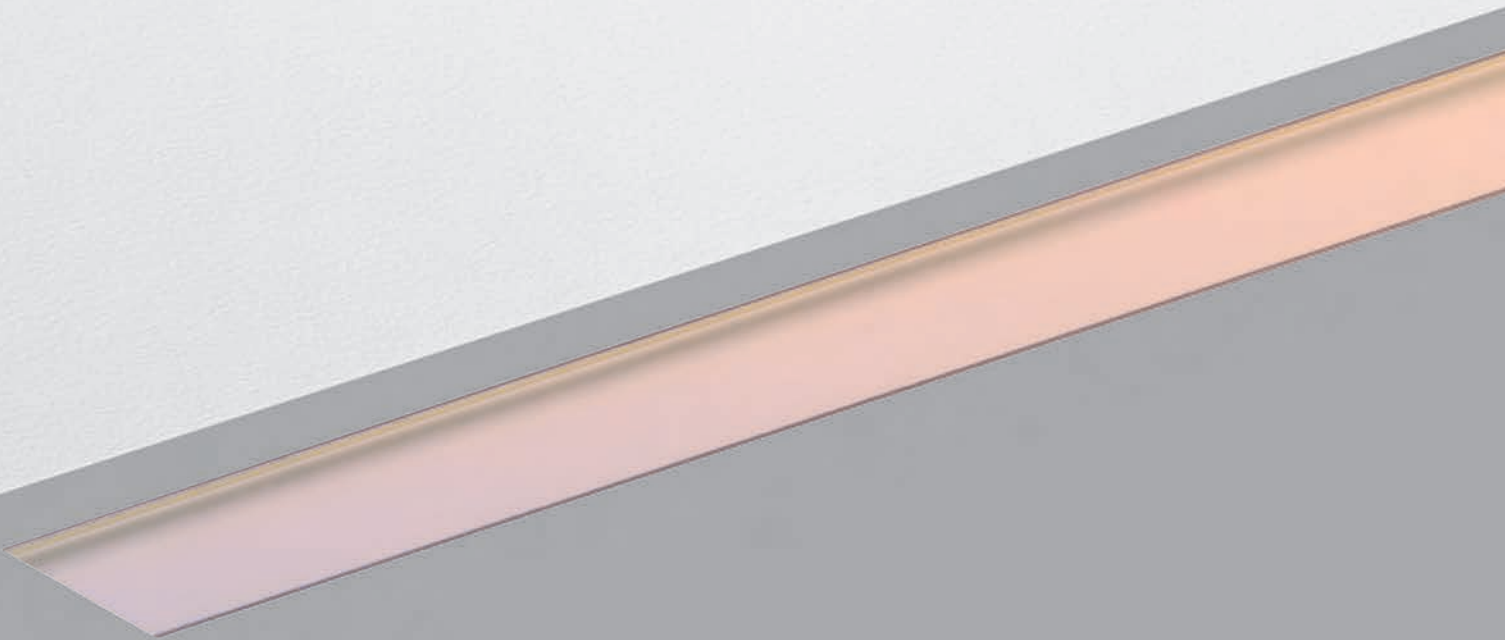

- Light fixture with high-performance LED light sources.
- Walk-over and drive-over recessed floor installation.
- Monochromatic or RGB light.
- Composed of body, diffuser, recessing box, closing end caps, junctions.
- Body in extruded EN AW6060 T5 aluminum.
- Opal non-slippery tempered glass 8mm-thick.
- Glass surface temperature lower than 35°.
- Profile end caps in injection-mould polycarbonate with silicone gasket.
- Recessing box for laying in stainless steel AISI 304.
- Recessing box end caps and junction in stainless steel AISI 304.
- Electrical connection to the ballast by means of a two-pole cable H05RN-F, with IP68 quick-release terminal block which is supplied with the fixture and can be housed in the recessing box.
- 24Vdc remote ballast.
- Body fastened to the recessing box by means of proper pre-stressed steel springs supplied with the fixture.
- Painted profile with 2-stage outdoor treatment: primer, outdoor paint.
- White monochromatic LEDs available in 2 colour temperatures:
Warm = 3000K
Neutral = 4000K
- RGB version with Full Colour RGB LEDs.
- IP Rating IP65/IP67.
- Insulation class III.
- Technical features of light fixtures in compliance with EN60598-1.

LineaLed

W	Length	CCT	CRI	Flux
5 W	618mm	3000 K	70	270 lm
		4000 K	75	300 lm
8 W	978mm	3000 K	70	432 lm
		4000 K	75	480 lm

Code
NL7398VSK0
NL7398VSW0
NL7419VSK0
NL7419VSW0

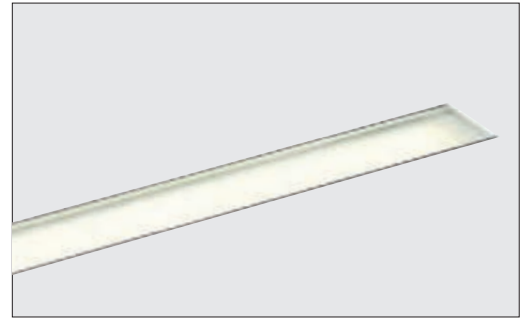

Driver 24Vdc SELV supplied separately

		5W	8W	
Driver	40W	24 Vdc	6 max	4 max
Driver	70W	24 Vdc	12 max	7 max
Driver	150W	24 Vdc	16 max	10 max
				NL62040
				NL89080
				NL62880

Maximum linear length of a series of products with one supply line: 6m. For lines of length exceeding 6m, provide multiple supply lines.

Housing	L=622mm	NL76670
Housing	L=982mm	NL76680
Continuity joint - 80 x 50 x 1,5mm		NL75810
Housing end cap (pair) - 46,5 x 62,5 x 1,5mm		NL74890
Power feed connector & connector end cap		NL19052

IP65/IP67

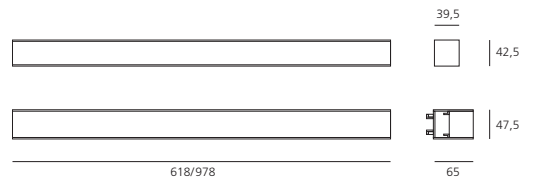

8 W

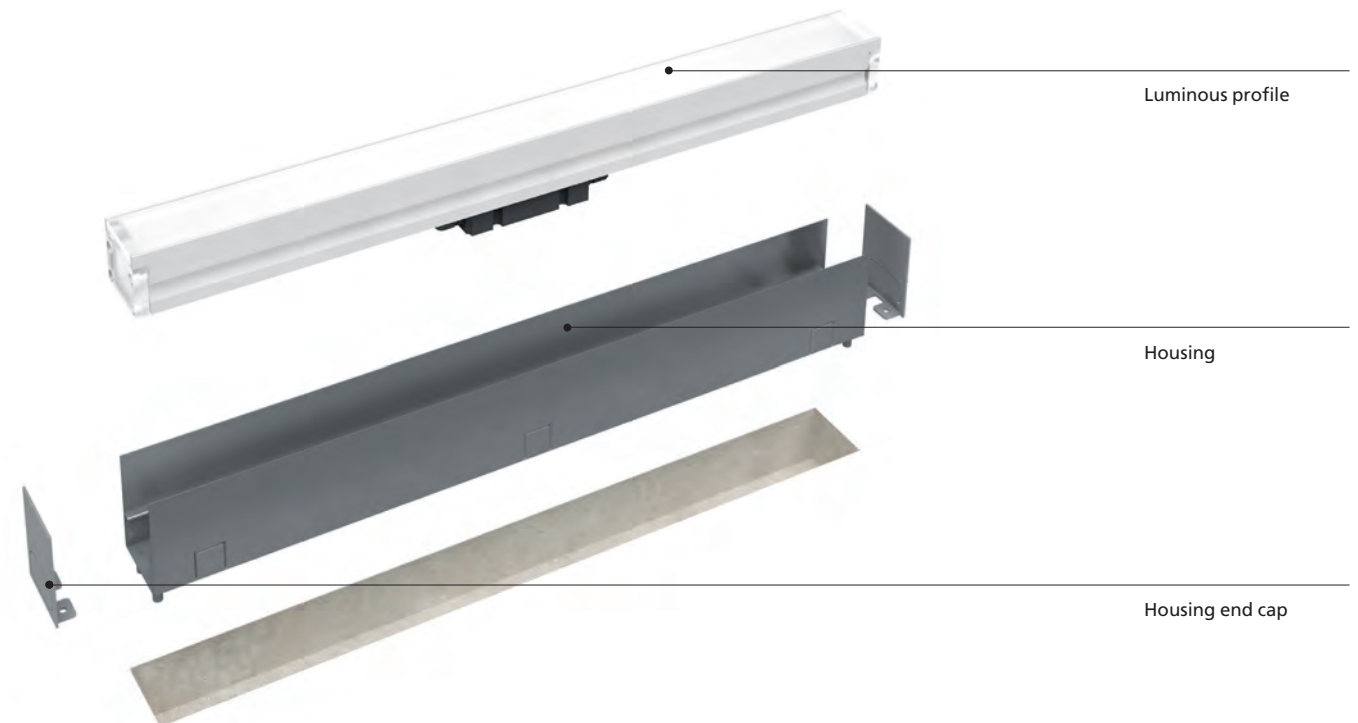
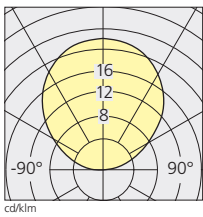

LineaLed RGB

W	Length
7 W	618mm
12 W	978mm

Code
NL76480
NL76490

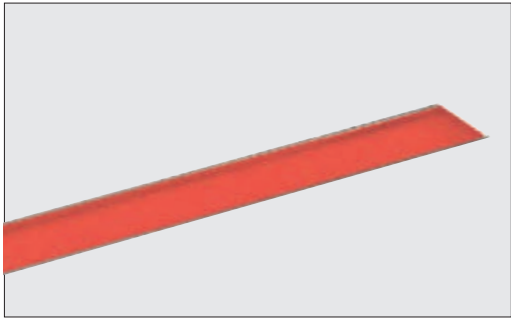

Driver 24Vdc SELV supplied separately

	7,2 W	12 W	
LED driver NLX2-70 IP65 70W 24Vdc PWM	8 max	5max	NL81260
LED driver NLX2-100 IP65 100W 24Vdc PWM	12 max	7max	NL84100
LED driver NLX2-150 IP65 150W 24Vdc PWM	18 max	10max	NL77270

PWM driver for fixtures with autonomous colour programmers for stand-alone or controlled working by means of DMX 512 protocol for installations of all sizes.

IP65/IP67 16,7 M

DSC 30 USB interfaced DMX stand alone

NL19030

Digital interface provided with software. If connected to the PC USB port, it transforms the programmers instructions into DMX 512 control signals. DSC30 (512 DMX controllable channels, real-time clock, local use) allows computer-interactive programming and stand-alone mode, that is the possibility of autonomous interface repetition without PC connection.

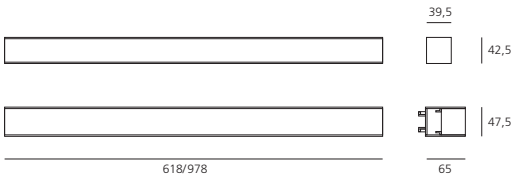

9W/350mA ballast with mini USB connector for DSC30

NL19031

50cm-long Cable with HE10 connector for connection to a keyboard

NL7833

Housing	L=622mm	NL76670
Housing	L=982mm	NL76680
Continuity joint - 80 x 50 x 1,5mm		NL75810
Housing end cap (pair) - 46,5 x 62,5 x 1,5mm		NL74890
Power supply connector & connector end cap		NL19052

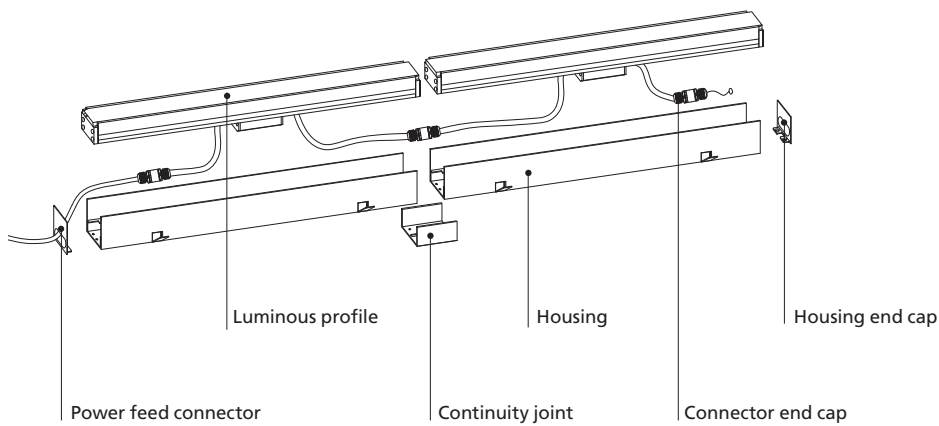

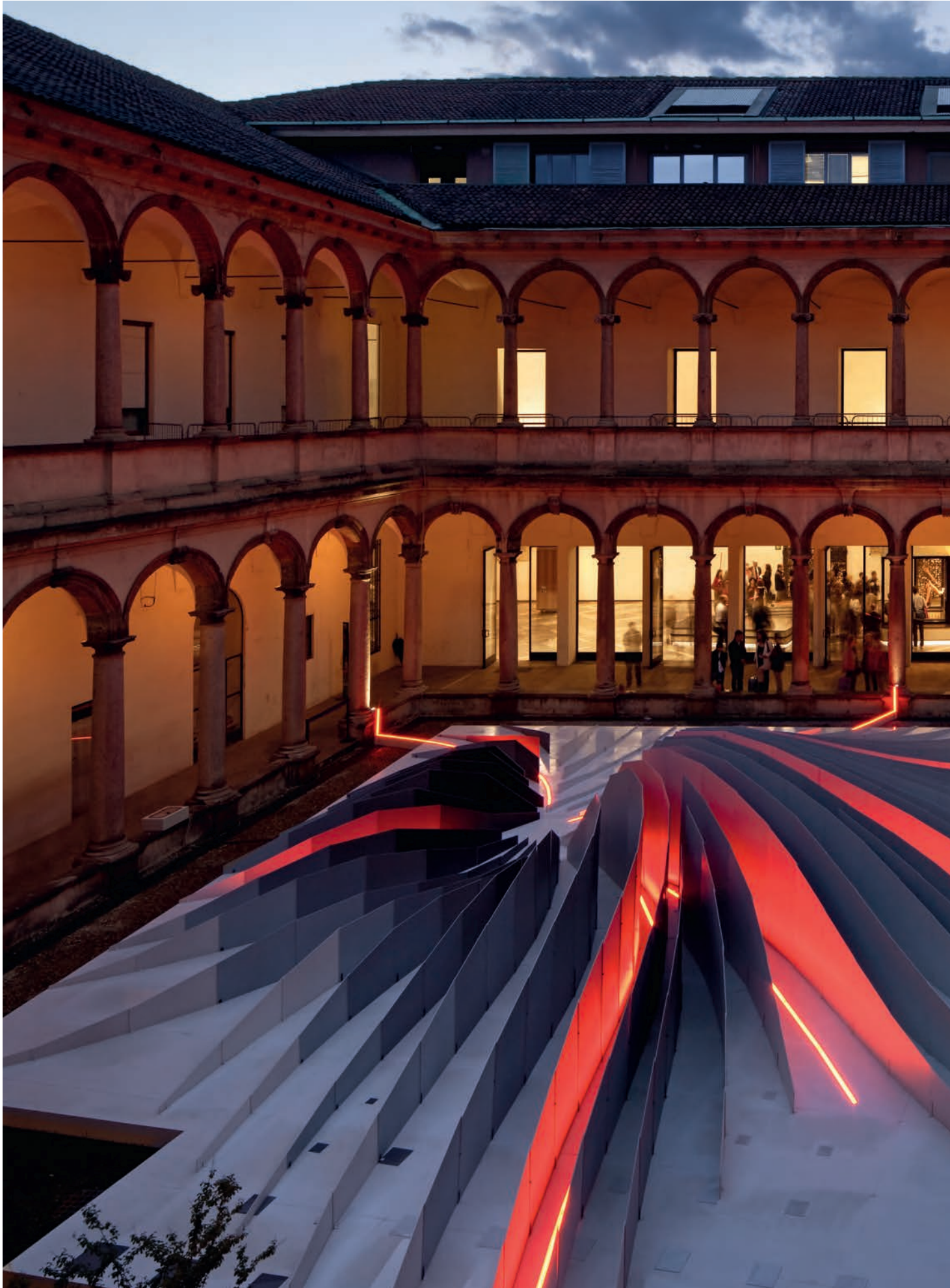



Twirl, Università Statale di Milano, Milan - IT, Project Zaha Hadid

LineaLed Wall Washer

Carlotta de Bevilacqua
2011

LineaLed Wallwasher

- Light fixture with high-performance LED light sources.
- Walk-over and drive-over recessed floor installation.
- Composed of body, diffuser, recessing box, closing end caps, junctions.
- Body in extruded EN AW6060 T5 aluminum.
- Transparent non-slippery tempered glass 8mm-thick.
- Profile end caps in injection-mould polycarbonate with silicone gasket.
- Recessing box for laying in stainless steel AISI 304.
- Recessing box end caps and junction in stainless steel AISI 304.
- Electrical connection to the ballast by means of a two-pole cable H05RN-F, with IP68 quick-release terminal block which is supplied with the fixture and can be housed in the recessing box.
- 24Vdc remote ballast.
- Body fastened to the recessing box by means of proper pre-stressed steel springs supplied with the fixture.
- Painted profile with 2-stage outdoor treatment: primer, outdoor paint.
- White monochromatic LEDs available in 2 colour temperatures:
Warm = 3000K
Neutral = 4000K
- IP Rating IP65/IP67.
- Insulation class III.
- Technical features of light fixtures in compliance with EN60598-1.
- Installation must be carried out by specialized personnel.
- Carefully follow the instructions.



Walk over and drive over approved up to 5000Kg.



LineLed Wallwasher adjustable

- Light fixture with high-performance LED light sources.
- Wall or ceiling installation.
- Composed by body in extruded aluminium, protection glass, adjustable brackets.
- Body in extruded EN AW6060 T5 aluminium.
- Transparent, non-slip tempered glass 8mm-thick.
- Glass surface temperature lower than 50°.
- Adjustment brackets in die-cast aluminium.
- Electrical connection to the ballast by means of two-pole cable H05RN-F, with IP68 terminal board supplied with the fixture.
- Polycarbonate end caps with silicone gasket.
- 24Vdc remote ballast.
- Painted profile and brackets with 2-stage outdoor treatment: primer, outdoor paint.
- Optics. PMMA lenses in 3 different versions of beams.
- White monochromatic LEDs available in 2 colour temperatures:
Warm = 3000K
Neutral = 4000K
- IP Rating IP65.
- Insulation class III.
- Technical features of light fixtures in compliance with EN60598-1.
- Installation must be carried out by specialized personnel.
- Carefully follow the instructions.

Spot optic

Concentrated luminous flow to highlight details avoiding unwanted light dispersion.

10° optic



Medium optic

Medium luminous flux to highlight details, large sections of windows..

25° optic



Wall Washer optic

Elliptical distribution of the luminous flow suitable for wall washer effect.

14°x34° optic



Chiesa di Capalbio Scalo, Capalbio - IT



W	Length	Flux	Beam	CRI	CCT	Code
8,5 W	300 mm	444 lm	10°	80	3000 K	NL1732010K0
				75	4000 K	NL1732010W0
		480 lm	25°	80	3000 K	NL1732025K0
				75	4000 K	NL1732025W0
			14°x34°	80	3000 K	NL17320ELK0
				75	4000 K	NL17320ELW0
17 W	500 mm	888 lm	10°	80	3000 K	NL1732110K0
				75	4000 K	NL1732110W0
		960 lm	25°	80	3000 K	NL1732125K0
				75	4000 K	NL1732125W0
			14°x34°	80	3000 K	NL17321ELK0
				75	4000 K	NL17321ELW0
25 W	780 mm	1334 lm	10°	80	3000 K	NL1732210K0
				75	4000 K	NL1732210W0
		1440 lm	25°	80	3000 K	NL1732225K0
				75	4000 K	NL1732225W0
			14°x34°	80	3000 K	NL17322ELK0
				75	4000 K	NL17322ELW0
34 W	978 mm	1776 lm	10°	80	3000 K	NL1732310K0
				75	4000 K	NL1732310W0
		1920 lm	25°	80	3000 K	NL1732325K0
				75	4000 K	NL1732325W0
			14°x34°	80	3000 K	NL17323ELK0
				75	4000 K	NL17323ELW0



IP65/67 IK07

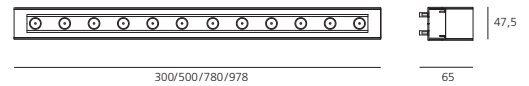

Driver 24Vdc SELV supplied separately

			8,5W	17 W	25 W	34 W	Code	
Driver	40W	IP67	24 Vdc	4max	2max	1max	1max	NL62040
Driver	70W	IP67	24 Vdc	7max	3max	2max	1max	NL89080
Driver	150W	IP67	24 Vdc	10max	5max	3max	2max	NL62880

Maximum linear length of a series of products with one feeding line: 2m. For lines of length exceeding 2m, provide multiple feeding lines.

Housing	L=300mm	NL17325H0
	L=500mm	NL17326H0
	L=780mm	NL17327H0
	L=980mm	NL76680
Continuity joint - 80 x 50 x 1,5mm		NL75810
Housing end cap (pair) - 46,5 x 62,5 x 1,5mm		NL74890
Power feed connector & connector end cap		NL19052

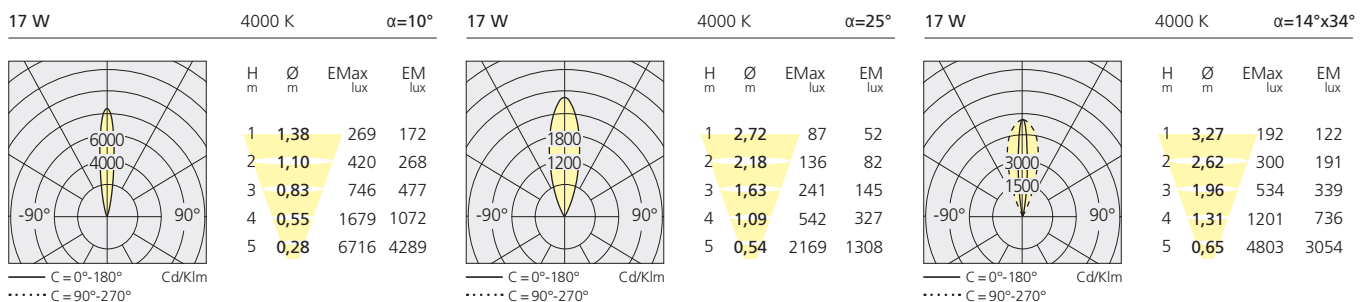
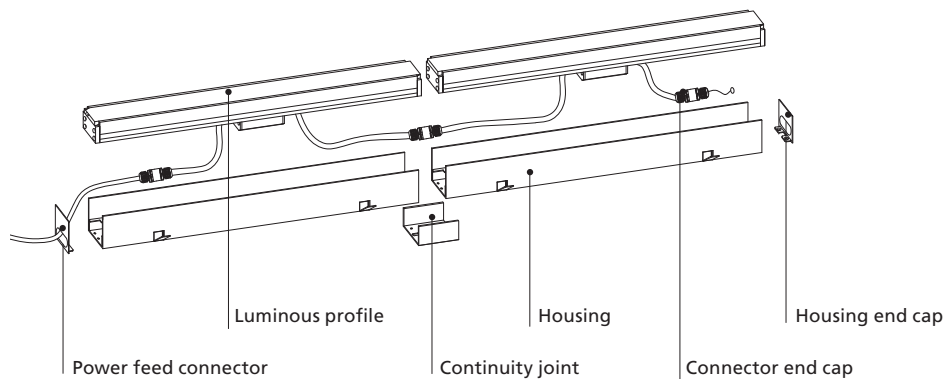

W	Length	Flux	Beam	CRI	CCT	Code
8,5 W	300 mm	444 lm 480 lm	10°	80	3000 K	NL1733010K0
				75	4000 K	NL1733010W0
			25°	80	3000 K	NL1733025K0
				75	4000 K	NL1733025W0
			14°x34°	80	3000 K	NL17330ELK0
				75	4000 K	NL17330ELW0
17 W	500 mm	888 lm 960 lm	10°	80	3000 K	NL1733110K0
				75	4000 K	NL1733110W0
			25°	80	3000 K	NL1733125K0
				75	4000 K	NL1733125W0
			14°x34°	80	3000 K	NL17331ELK0
				75	4000 K	NL17331ELW0
25 W	780 mm	1334 lm 1440 lm	10°	80	3000 K	NL1733210K0
				75	4000 K	NL1733210W0
			25°	80	3000 K	NL1733225K0
				75	4000 K	NL1733225W0
			14°x34°	80	3000 K	NL17332ELK0
				75	4000 K	NL17332ELW0
34 W	978 mm	1776 lm 1920 lm	10°	80	3000 K	NL1733310K0
				75	4000 K	NL1733310W0
			25°	80	3000 K	NL1733325K0
				75	4000 K	NL1733325W0
			14°x34°	80	3000 K	NL17333ELK0
				75	4000 K	NL17333ELW0



IP65 IK07

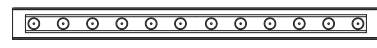

300/500/780/978



42

Driver 24Vdc SELV supplied separately

				8,5W	17 W	25 W	34 W	Code
Driver	40W	IP67	24 Vdc	4max	2max	1max	1max	NL62040
Driver	70W	IP67	24 Vdc	7max	3max	2max	1max	NL89080
Driver	150W	IP67	24 Vdc	10max	5max	3max	2max	NL62880

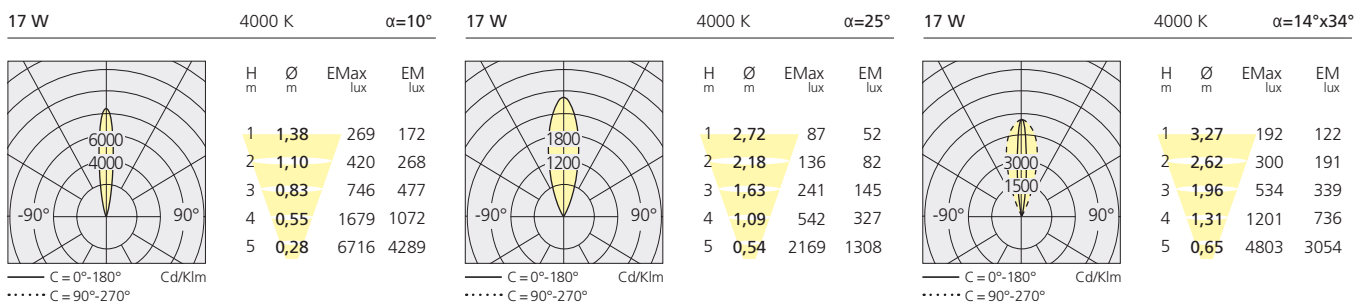



- Light fixture with 5mm LED light sources.
- Wall and ceiling installation by means of special accessories (clips).
- 26mm-diameter body in UV-stabilised transparent polycarbonate.
- End caps in PVC with o-ring gasket and insulating resin.
- IP68 cable gland PG7 in polyamide.
- Electrical connection to the mains by means of cable H05RN-F (monochromatic version) or cable FEP-FEP (RGB version).
- Optional IP68 terminal boards.
- PVC clips for fixing and adjustment (standard supply).
- Glow wire test 960°C.
- White monochromatic LEDs available in 2 colour temperatures:
Warm = 2900K
Neutral = 4500K
- RGB version with red, green and blue monochromatic LEDs.
- IP Rating IP65.
- Insulation class III.
- Technical features of light fixtures in compliance with EN60598-1 and part 2-13.
- Installation must be carried out by specialized personnel.
- Carefully follow the instructions.

CRI = 80(min)

W	Length	Weight	Beam	Flux	CCT
16 W	850 mm	0,26kg	50°	400 lm 416 lm	2900K 4500K
23 W	1250 mm	0,35kg	50°	575 lm 598 lm	2900K 4500K

Driver 28Vac SELV supplied separately

Transformer	V(ac)	L _{mm}	W _{mm}	H _{mm}	IP	16W	23W
50VA 28Vac	230	85	70	60	67	2max	1max
250VA 28Vac	230	140	105	85	67	13max	9max
400VA 28Vac	230	140	105	85	67	20max	15max

Mounting clip

Single connection

Code
NL704750K0
NL704750T0
NL704850K0
NL704850T0

Double connection

Code
NL704750K1
NL704750T1
NL704850K1
NL704850T1



IP65

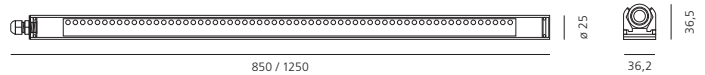

Single connection

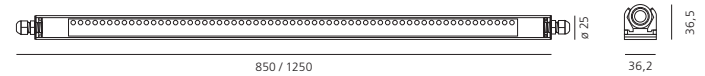

Double connection

Maximum total length of fixtures connected in series: 6 meters

23 W 4500 K α=55°

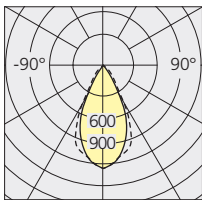

cd/klm

H m	ØC0 m	ØC90 m	E lux
0,5	0,46	0,51	4606
1,0	0,92	1,02	1152
1,5	1,39	1,54	512
2,0	1,85	2,05	288
2,5	2,31	2,56	184
3,0	2,77	3,07	128

RGB

W	Length	Weight	Beam
14 W	840 mm	0,25kg	30°
21 W	1230 mm	0,35kg	30°

Driver 24Vdc SELV supplied separately

	14W	21W
Driver NLX 2-70	70 W	24Vdc PWM
Driver NLX 2-100	100 W	24Vdc PWM

DSC 30 USB interface DMX stand alone
9V/350mA ballast with mini USB connector for DSC30
50cm cable with HE10 connector for keyboard (optional)

Mounting clip

Single connection

Code
NL75320
NL75340

Double connection

Code
NL75321
NL75341



IP65 CE

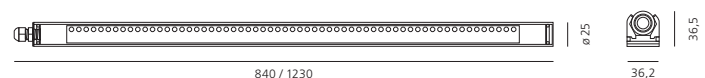

Single connection

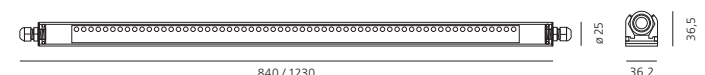

Double connection







- Light fixture with high-performance LED light sources.
- Floor, wall, ceiling installation by means of fixing clips (not included).
- Monochromatic or RGB light.
- Body in UV-stabilised transparent polycarbonate.
- Electrical connection to the ballast by means of a FROR cable (monochrome) or FEP cable (RGB) with appropriate terminal board supplied.
- 24Vdc remote ballast.
- Polycarbonate end caps.
- Body fastened to the recessing box by means of proper pre-stressed steel springs to be ordered separately.
- White monochromatic LEDs available in 2 colour temperatures:
Warm = 3000K
Neutral = 4000K
- RGB version with Full Colour RGB LEDs.
- IP65 or IP40 protection rate.
- Insulation class III.
- Technical features of light fixtures in compliance with EN60598-1.
- Installation must be carried out by specialized personnel.
- Carefully follow the instructions.



Palazzo Tornabuoni Residence Club, Florence - IT Lighting: Arch. Michele Bonan, Arch. Jan Van Lierde

Riga

CRI = 80(min)

W	L	Weight	Beam	CCT
2 W	540	0,09kg	140°	3000K 4000K
3 W	780	0,10kg	140°	3000K 4000K
4 W	1020	0,11kg	140°	3000K 4000K

IP65

Code
NL17400VTKO
NL17400VTW0
NL17401VTKO
NL17401VTW0
NL17402VTKO
NL17402VTW0

IP40

Code
NL17405VTKO
NL17405VTW0
NL17406VTKO
NL17406VTW0
NL17407VTKO
NL17407VTW0



Driver 24Vdc SELV supplied separately

	2 W	3 W	4 W		
Driver	40 W	24Vac	15 max	10 max	8 max
Driver	70 W	24Vac	25 max	18 max	14 max
Driver	150 W	24Vac	60 max	40 max	30 max

NL62040
NL89080
NL62880

540 / 780 / 1020

4 W 4000 K α=140°

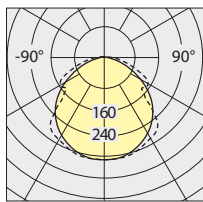

H	∅C0	∅C90	E
m	m	m	lux
0,5	1,52	1,38	265
1,0	3,03	2,75	66
1,5	4,55	4,13	29
2,0	6,07	5,51	17
2,5	7,58	6,88	11
3,0	9,10	8,26	7

cd/klm
 - - - - C0 - C180
 ······ C90 - C270

RGB

W	L	Weight	Beam
6 W	540	0,10kg	140°
9 W	780	0,11kg	140°
12 W	1020	0,12kg	140°

Driver 24Vdc SELV supplied separately

	6 W	9 W	12 W				
Driver	NLX 2-70	70 W	24Vdc	PWM	10max	7max	5max
Driver	NLX 2-100	100 W	24Vdc	PWM	14max	9max	7max

Code

NL17421
NL17422
NL17423



IP65

DSC 30 USB interface DMX stand alone
 9V/350mA ballast with mini USB connector for DSC30
 50cm cable with HE10 connector for keyboard
 (optional)

NL19030
NL19031
NL7833

540 / 780 / 1020

Accessories



Fixing bracket
 24,5x12x10,5 mm

Code
NL89090



Fixing bracket
 37x12x10,5 mm

NL88520



Fixing bracket
 29,2x15x10,5 mm

NL86610

Riga plus

CRI = 80(min)				
W	L	Weight	Beam	CCT
4 W	540	0,40kg	140°	3000K
				4000K
6 W	780	0,50kg	140°	3000K
				4000K
8 W	1020	0,60kg	140°	3000K
				4000K

Driver 24Vdc SELV supplied separately

			4 W	6 W	8 W	
Driver	40 W	24Vac	8max	5max	4max	NL62040
Driver	70 W	24Vac	14max	9max	7max	NL89080
Driver	150 W	24Vac	30max	20max	15max	NL62880

IP65
Code
NL50040VTKO
NL50040VTW0
NL50041VTKO
NL50041VTW0
NL50042VTKO
NL50042VTW0

IP40
Code
NL50037VTKO
NL50037VTW0
NL50038VTKO
NL50038VTW0
NL50039VTKO
NL50039VTW0

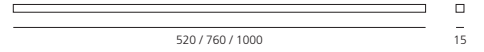

520 / 760 / 1000

□
—
15

RGB				
W	L	Weight	RGB	Beam
5 W	585	0,10kg	16,7m	140°
6 W	760	0,11kg		140°
8 W	935	0,12kg		140°

Driver 24Vdc SELV supplied separately

				5 W	6 W	8 W	
Driver	NLX 2-70	70 W	24Vdc	PWM 10max	8max	6max	NL81260
Driver	NLX 2-100	100 W	24Vdc	PWM 14max	10max	8max	NL84100

DSC 30 USB interface DMX stand alone
9V/350mA ballast with mini USB connector for DSC30
50cm cable with HE10 connector for keyboard
(optional)

Code
NL50044
NL50045
NL50046

NL81260
NL84100

NL19030
NL19031

NL7833



IP65

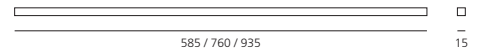

585 / 760 / 935

□
—
15

Accessories

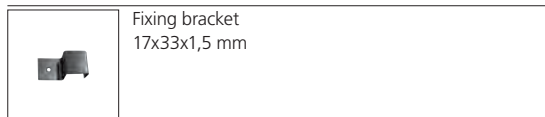

Fixing bracket
17x33x1,5 mm

Code
NL50049

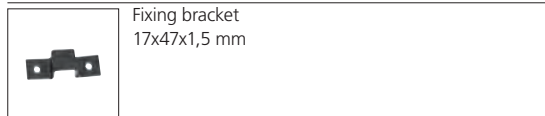

Fixing bracket
17x47x1,5 mm

NL50048



- Light fixture with high-performance LED light sources.
- Ceiling, wall or floor installation.
- Flexible profile.
- Flexible UV-resistant polyurethane resin rim.
- Accurate led selection equal to 3-Step MacAdam, ensuring colour consistency.
- 3M adhesive film to fix the product, supplied with the fixture.
- Remote driver.
- Electrical connection to the driver by means of H05RN-F (IP65) or FEP-FEP cable (IP40), and appropriate terminal board, provided with the fixture.
- White monochromatic LEDs available in 2 colour temperatures:
Warm = 3200K
Neutral = 3800K
- RGB Full colour LED.
- IP Rating IP65 or IP40.
- Insulation class III.
- Operating temperature -20°C / +40°C.
- Technical features of light fixtures in compliance with EN60598-1.
- Installation must be carried out by specialized personnel.
- Carefully follow the instructions.

Dedalo

CRI = 80(min)

W	L mm	Weight	Beam	Flux	CCT
24 W	5000	0,60kg	140°	1104 lm	3200K
				300 LED	3800K
48 W	5000	0,60kg	140°	2202 lm	3200K
				600 LED	3800K

IP65

Code
NL17034VTK0
NL17034VTW0
NL17034VTK1
NL17034VTW1

IP40

Code
NL17032VTK0
NL17032VTW0
NL17032VTK1
NL17032VTW1

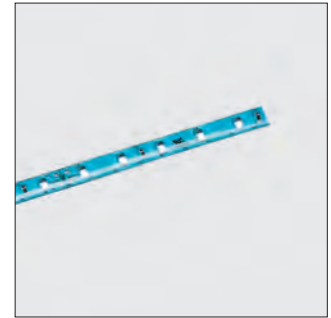

Driver 24Vdc SELV supplied separately

Driver	Vac	L _{mm}	W _{mm}	H _{mm}	IP	24W	48W
cv 40W 24Vdc	220-240	268	66	55	67	1max	
cv 70W 24Vdc	220-240	268	66	51	67	2max	1max
cv 70W 24Vdc	220-240	240	60	49	67	2max	1max
cv 150W 24Vdc	220-240	268	66	51	67	5max	2max

Connection Kit (1 male - 2 female)

Code
NL62040
NL89080
NL8711
NL62880
NL170330

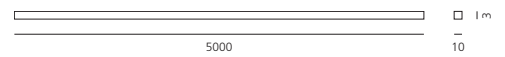

RGB

W	L mm	Weight	RGB	Beam
60 W	5000	0,60kg	16,7m	100°
240 LED				

IP65

Code
NL17037

IP40

Code
NL17036



Driver 24Vdc SELV supplied separately

Driver	Vac	L _{mm}	W _{mm}	H _{mm}	IP	Code
cv75W 12Vdc PWM	220-240	153	50	23	1max	NL19084

DSC 30 USB interface DMX stand alone	NL19030
9V/350mA ballast with mini USB connector for DSC30	NL19031
50cm cable with HE10 connector for keyboard (optional)	NL7833

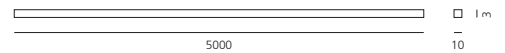



Accent Lighting	656	Minispot
	658	Ego Spot
	664	Epulo
	670	Falange
	674	Obice
	678	Cariddi
	680	Sostituto Spot
	682	Cefiso

- Light fixture with high-performance LED light sources.
- Ground, floor, wall installation.
- Consists of body, metal ring, diffuser in transparent polycarbonate.
- Body and metal ring in anticorrosive aluminium, anodized.
- Silicone o-ring gaskets.
- Remote driver supplied separately.
- Power connection to the driver by means of H05RN-F cable and IP68 electrical terminal board, supplied with the fixture.
- Fixed optic. PMMA lenses in 3 different versions of beams.
- White monochromatic LEDs available in 2 colour temperatures:
Warm = 3000K
Neutral = 4000K
- Picket for ground installation.
- Technical features of light fixtures in compliance with EN60598-1 and part 2-13.
- IP Rating IP65.
- Insulation class III.
- Installation must be carried out by specialized personnel.
- Carefully follow the instructions.



Minispot

Silver

CRI 80			
W	Beam	Flux	CCT
2,5 W	10°	74 lm	3000 K
		80 lm	4000 K
	25°	74 lm	3000 K
		80 lm	4000 K
	40°	74 lm	3000 K
		80 lm	4000 K

Code
NL702910K0
NL702910W0
NL702925K0
NL702925W0
NL7029ELK0
NL7029ELW0



IP65

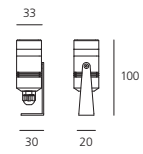

Driver 700mA SELV supplied separately

Driver	V(ac)	L _{mm}	W _{mm}	H _{mm}	IP	Code
cc 11 W 700mA	220-240	145	65	55	67	1 - 4 max NL19024
cc 19 W 700mA	220-240	145	65	55	67	7 NL19028
cc 35 W 700mA	220-240	145	65	55	67	7 - 13 max NL19029

Picket in anodised metal 37 x 180mm

NL97150

2,5 W

$\alpha=10^\circ$

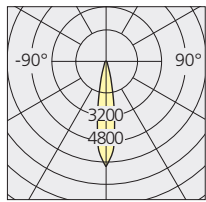

H _m	ØC0 _m	ØC90 _m	E _{lux}
0,5	0,16	0,16	1923
1	0,32	0,32	481
1,5	0,48	0,48	214
2	0,64	0,64	120
2,5	0,80	0,80	77
3	0,96	0,96	53

2,5 W

$\alpha=25^\circ$

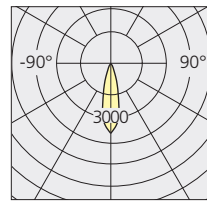

H _m	ØC0 _m	ØC90 _m	E _{lux}
0,5	0,23	0,23	1034
1	0,46	0,46	259
1,5	0,69	0,69	115
2	0,92	0,92	65
2,5	1,15	1,15	41
3	1,39	1,39	29



Ego Spot

2005





- Light fixture with high-performance LED light sources.
- Ground, floor, wall installation.
- Consists of body, frame, glass and bracket.
- Aluminium folded sheet bracket. All aluminium components are anodized.
- Diffuser in glass, 10mm-thick.
- Gaskets in EPDM.
- Remote driver supplied separately.
- Power connection to the driver by means of H05RN-F cable and IP68 electrical terminal board, supplied with the fixture.
- Fixed optic. PMMA lenses in 3 different versions of beams.
- White monochromatic LEDs available in 2 colour temperatures:
Warm = 3000K
Neutral = 4000K
- Picket for ground installation in galvanized sheet iron.
- Painted aluminium with 2-stage outdoor treatment: antioxidant primer, polyester paint.
- Technical features of light fixtures in compliance with EN60598-1 and part 2-13.
- IP Rating IP65.
- Insulation class III.
- Installation must be carried out by specialized personnel.
- Carefully follow the instructions.



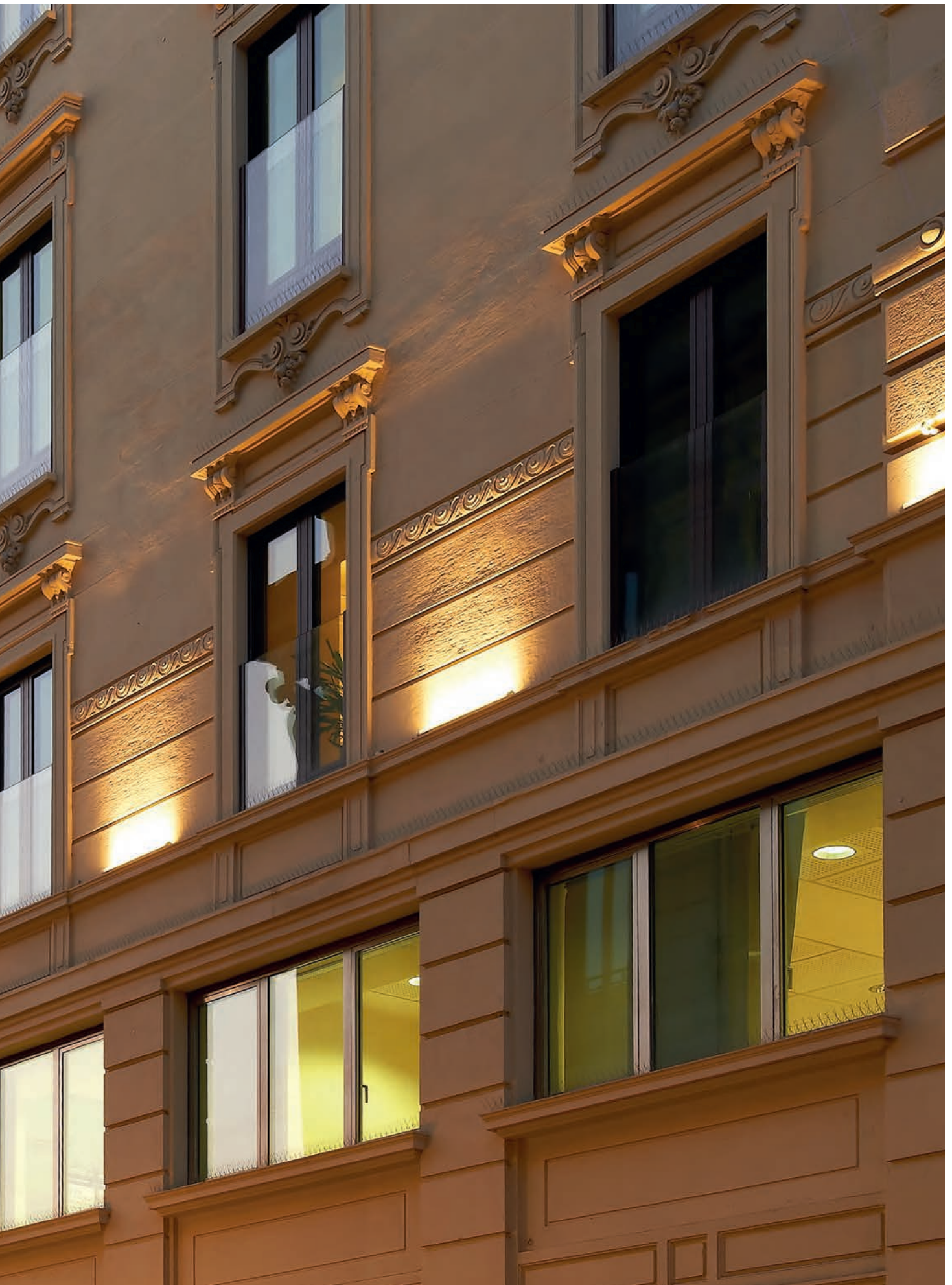

Spot optic

Concentrated luminous flow to highlight details avoiding unwanted light dispersion.

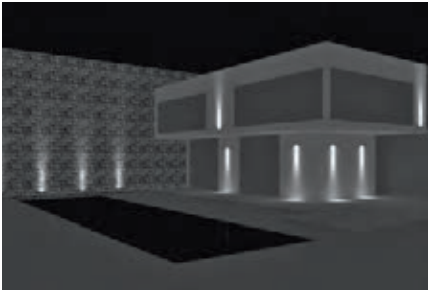

10° optic

Medium optic

Medium luminous flux to highlight details, large sections of windows.

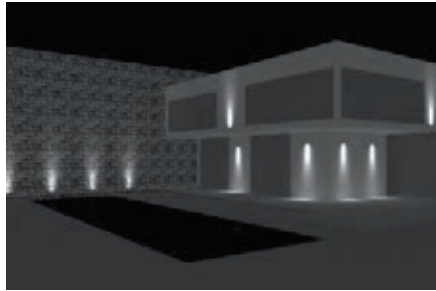

32° optic

Wallwasher optic

Elliptical distribution of the luminous flow suitable for wallwasher effect.

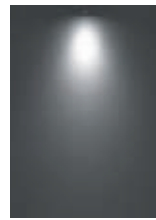
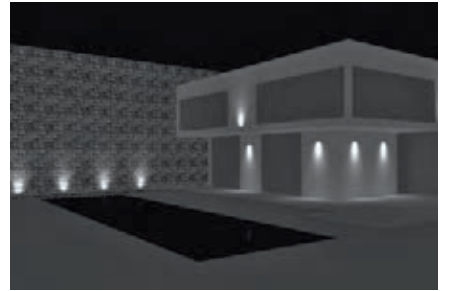

40°x20° optic



Ego Spot 6 24Vdc

W	Beam	CRI	Flux	CCT
12 W	10°	80	826 lm	3000K
			881 lm	4000K
	32°	80	740 lm	3000K
			789 lm	4000K
	40°x20°	80	732 lm	3000K
			781 lm	4000K

Code
T7633SPW00
T7633SPN00
T7633FLW00
T7633FLN00
T7633ELPTW00
T7633ELPTN00



Driver 24Vdc SELV supplied separately

Driver	40W	24Vdc	IP67	3 max
Driver	70W	24Vdc	IP67	5 max
Driver	150W	24Vdc	IP67	10 max
Picket				

NL62040
NL89080
NL62880
NL97150

IP65

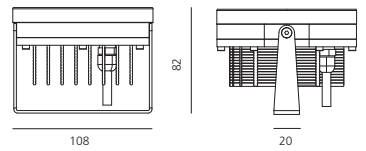

29.5

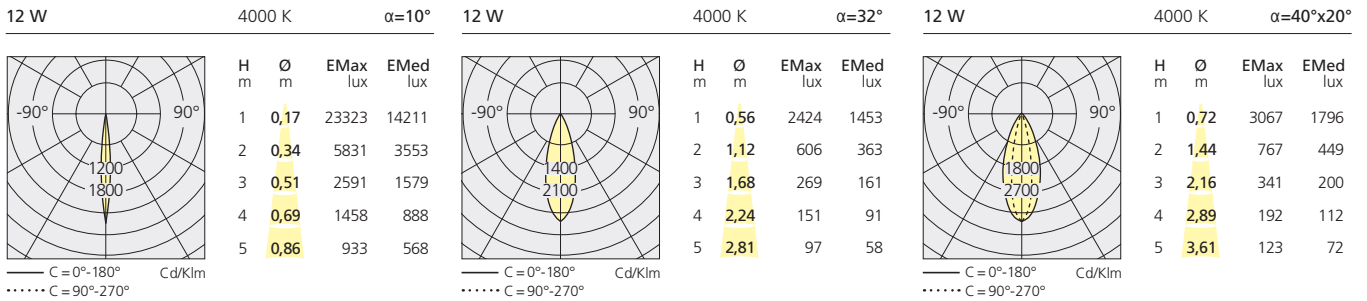

Ego Spot 72 RGB

W	Beam	Code
12W RGB	30°	NL75230

Driver 24Vdc SELV supplied separately

LED driver NLX 2-70	IP65	70W	24Vdc	PWM	5 max	NL81260
LED driver NLX 2-100	IP65	100W	24Vdc	PWM	7 max	NL84100

PWM driver for fixtures with autonomous colour programmes for stand-alone or controlled working by means of DMX 512 protocol for installations of all sizes.



IP65

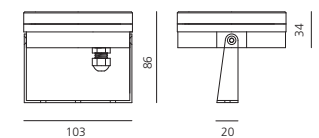

DSC 30 USB interfaced DMX stand alone

NL19030

Digital interface provided with software. If connected to the PC USB port, it transforms the programme instructions into DMX 512 control signals. DSC30 (512 DMX controllable channels, real-time clock, local use) allows computer-interactive programming and stand-alone mode, i.e. the possibility of autonomous interface repetition without PC connection.

9V/350mA ballast with mini USB connector for DSC30

NL19031

50cm-long Cable with HE10 connector for connection to a keyboard

NL7833

Picket

NL50035

- Light fixture with adjustable direct emission, with high-performance LED light sources.
- Floor, wall and eaves installation.
- 2 sizes: Epulo 13 and Epulo 18.
- Available in two finishes: grey-white painted and anthracite grey painted.
- Consists of lighting unit, terminal board and fixing bracket. Rotation on the base $\pm 180^\circ$, side body tilt $\pm 45^\circ$ and front body tilt $\pm 90^\circ$ by means of a spherical joint allowing an accurate adjustment.
- Body and terminal board in EN AB44100 aluminium, fixing bracket in stainless steel, silicone gaskets. Electronic ballast integrated in the body.
- Silkscreened tempered glass siliconed flush with the body to avoid backwater.
- IP67 connector for electric connection to the mains, it can be housed in the terminal board compartment and is suitable for cables with a diameter of 5-13.5mm.
- PMMA lenses in 3 different versions of beams.
- White monochromatic LEDs available in 2 colour temperatures:
Warm = 3000K
Neutral = 4000K
- Screws in AISI 316 stainless steel.
- The components in die-cast aluminium and the steel bracket are painted with 3-stage outdoor treatment: nanotechnologies, antioxidant primer, polyester paint.
- Technical features of light fixtures in compliance with EN60598-1 and part 2-5.
- IP Rating IP65.
- Insulation class I.



Maximum adjustment flexibility (rotation 360°, front tilting 180°, side tilting 90°).

Nano ceramic paint ensures very high resistance to corrosion.



W	Beam	CCT	CRI	Flux	Color	Code
22 W	6°	3000 K	80	1231 lm	○	T418910W00
		4000 K	80	1323 lm	●	T418910W10
	40°	3000 K	80	1187 lm	○	T418910N00
		4000 K	80	1276 lm	●	T418910N10
	54°x6°	3000 K	80	1198 lm	○	T418939W00
		4000 K	80	1288 lm	●	T418939W10
					○	T418939N00
					●	T418939N10
					○	T4189ELW00
					●	T4189ELW10
					○	T4189ELN00
					●	T4189ELN10



IP65 IK06

220/240Vac 50/60Hz electronic ballast included

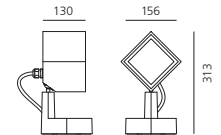

22 W				4000 K				α=6°				22 W				4000 K				α=40°				22 W				4000 K				α=54°x6°			
H	Ø	EMax	EMed	H	Ø	EMax	EMed	H	Ø	EMax	EMed	H	Ø	EMax	EMed	H	Ø	EMax	EMed	H	Ø	EMax	EMed	H	Ø	EMax	EMed	H	Ø	EMax	EMed				
m	m	lux	lux	m	m	lux	lux	m	m	lux	lux	m	m	lux	lux	m	m	lux	lux	m	m	lux	lux	m	m	lux	lux	m	m	lux	lux				
1	0,09	74555	47384	1	0,71	2429	1525	1	1,04	6575	4085	1	0,09	74555	47384	1	0,71	2429	1525	1	1,04	6575	4085	1	0,09	74555	47384	1	0,71	2429	1525				
2	0,19	18639	11846	2	1,42	607	381	2	2,07	1644	1021	2	0,19	18639	11846	2	1,42	607	381	2	2,07	1644	1021	2	0,19	18639	11846	2	1,42	607	381				
3	0,28	8284	5265	3	2,14	270	169	3	3,11	731	454	3	0,28	8284	5265	3	2,14	270	169	3	3,11	731	454	3	0,28	8284	5265	3	2,14	270	169				
4	0,37	4660	2962	4	2,85	152	95	4	4,15	411	255	4	0,37	4660	2962	4	2,85	152	95	4	4,15	411	255	4	0,37	4660	2962	4	2,85	152	95				
5	0,47	2982	1895	5	3,56	97	61	5	5,18	263	163	5	0,47	2982	1895	5	3,56	97	61	5	5,18	263	163	5	0,47	2982	1895	5	3,56	97	61				

Spot optic

Concentrated luminous flow to highlight details avoiding unwanted light dispersion.
6° optic.

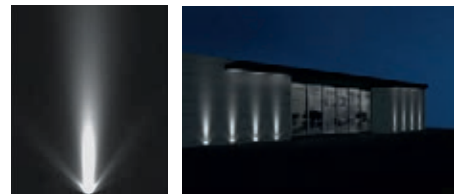

Flood optic

Wide luminous flow suitable for lighting large areas.
40° optic.

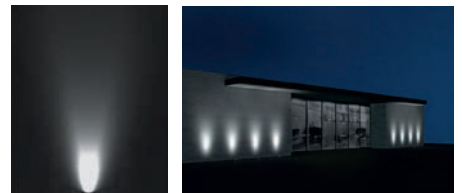

Wallwasher optic

Elliptical distribution of the luminous flow suitable for wallwasher effect.
54°x6° optic

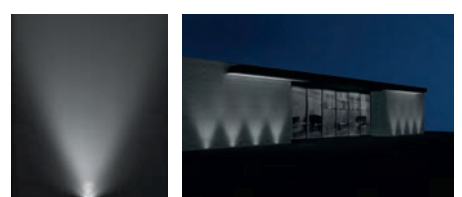



W	Beam	CCT	CRI	Flux	Color	Code
37 W	6°	3000 K	80	2188 lm	○	T418810W00
		4000 K	80	2353 lm	●	T418810W10
	40°	3000 K	80	2110 lm	○	T418810N00
		4000 K	80	2269 lm	●	T418810N10
54°x6°	3000 K	80	2136 lm	○	T418839W00	
		80	2269 lm	●	T418839W10	
	4000 K	80	2136 lm	○	T418839N00	
		80	2297 lm	●	T418839N10	
	4000 K	80	2136 lm	○	T4188ELW00	
		80	2297 lm	●	T4188ELW10	
					○	T4188ELN00
					●	T4188ELN10



IP65 IK06

220/240Vac 50/60Hz electronic ballast included

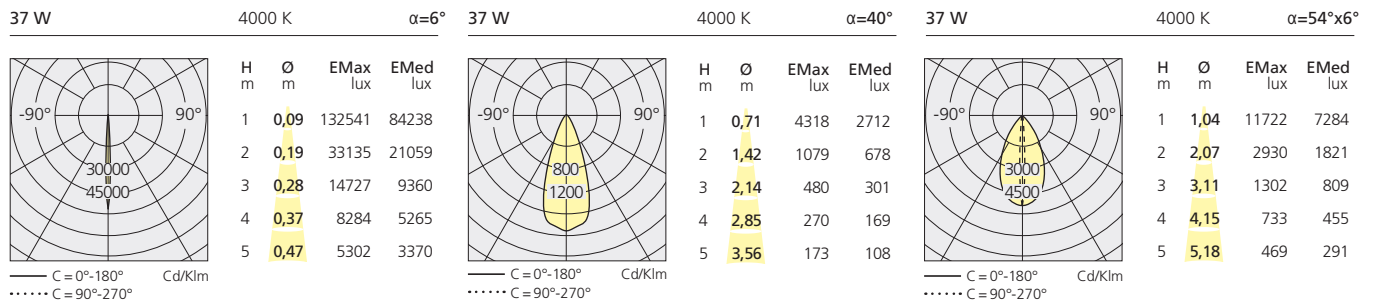
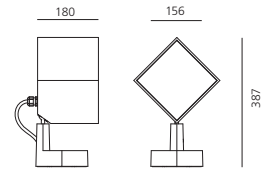





Falange

Wilmotte & Industries
2011

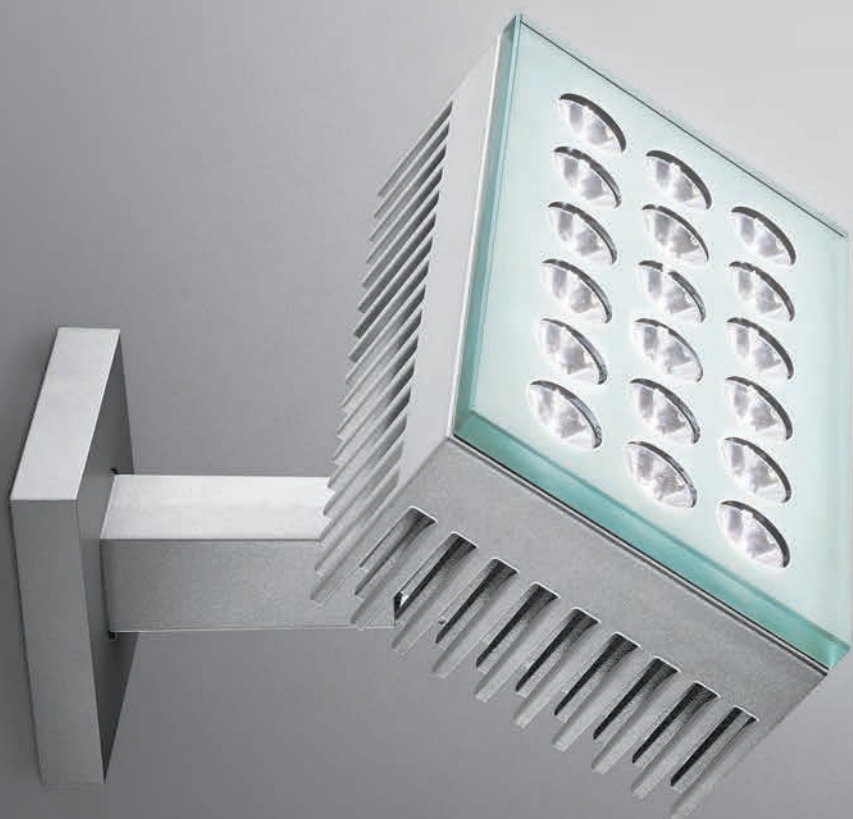



- Adjustable light fixture with direct emission, with high-performance LED light sources.
- Ground, wall, eaves installation.
- 2 sizes: 134x134, 238x134 mm.
- Composed by adjustable lighting unit and support (housing the wiring). Rotation on the base $\pm 60^\circ$, body tilt $\pm 180^\circ$ by means of a graduated metal ring allowing an accurate adjustment. Positioning is maintained by means of locking dowels.
- Body and support in EN AB44100 aluminium, silicone gaskets.
- Electronic ballast integrated in the body.
- Silkscreened tempered glass silicined to a secondary frame.
- Wiring to be carried out by means of plug IP 68.
- PMMA lenses in 3 different versions of beams.
- White monochromatic LEDs available in 2 colour temperatures:
Warm = 3000K
Neutral = 4000K
- AISI 316 stainless steel screws.
- Painted die-cast aluminium with 3-stage outdoor treatment: nanotechnologies, antioxidant primer, polyester paint.
- Technical features of light fixtures in compliance with EN60598-1 and part 2-5.
- IP Rating IP65.
- Insulation class I.

Spot optic

Concentrated luminous flow to highlight details avoiding unwanted light dispersion.

Flood optic

Wide luminous flow suitable for lighting large areas.

Wall Washer optic

Elliptical distribution of the luminous flow suitable for wall washer effect.

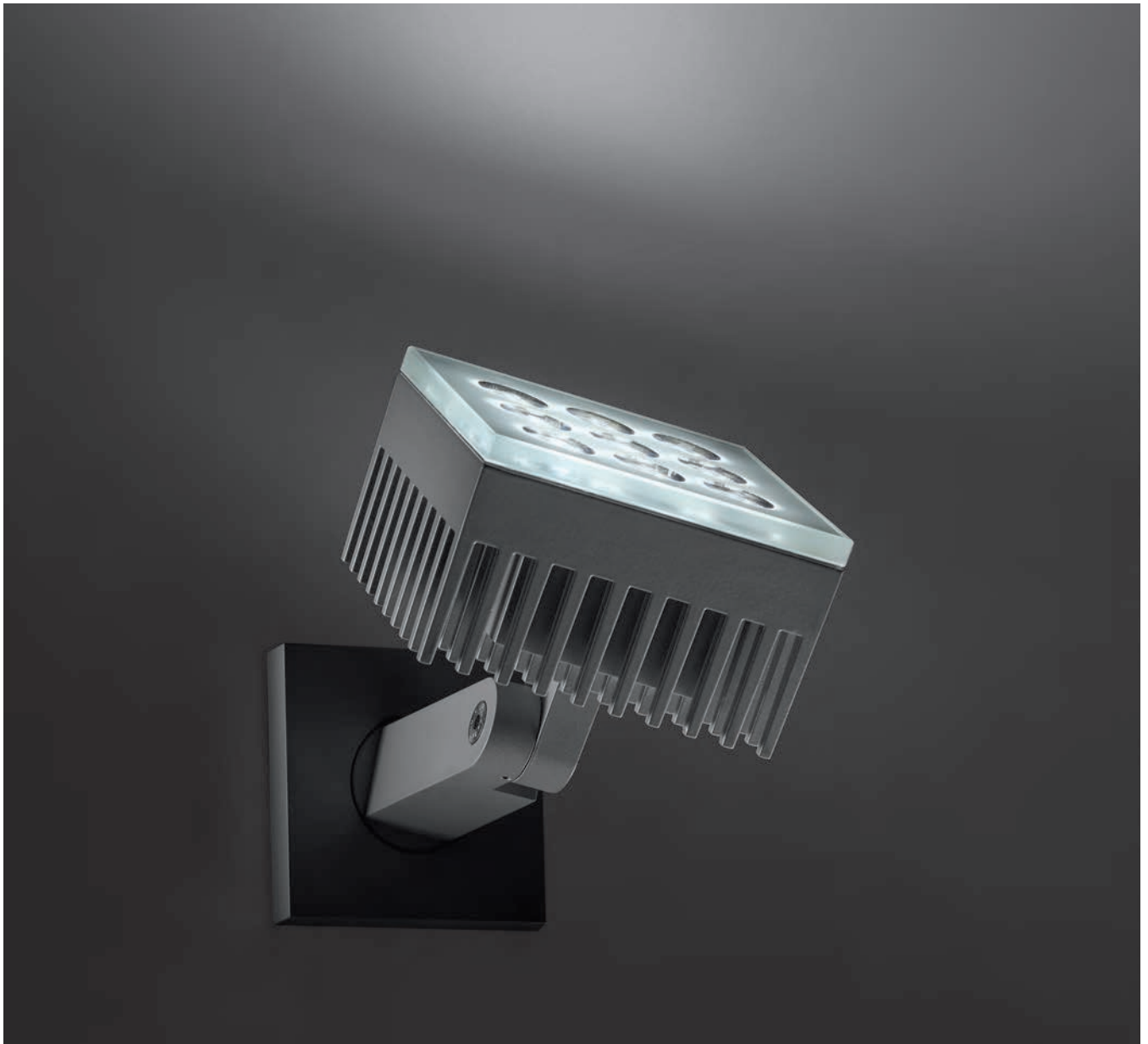
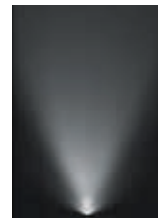
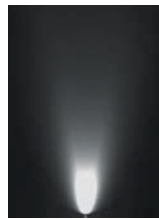
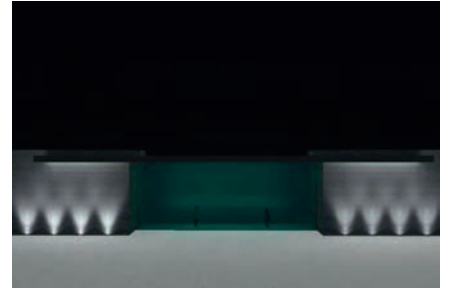
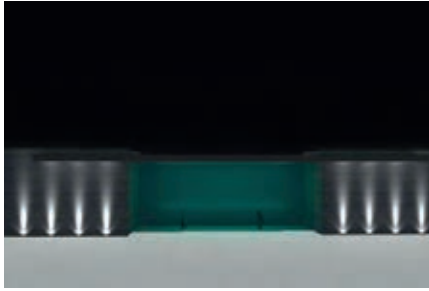

Falange

Grey-white RAL9002 Anthracite grey

Falange 9

W	Beam	Flux	CCT	CRI	Color	Code
22 W	6°	1231 lm	3000 K	80		NL3000010K002
		1324 lm	4000 K	80		NL3000010K005
	40°	1187 lm	3000K	80		NL3000010W002
		1276 lm	4000K	80		NL3000010W005
	54°x6°	1198 lm	3000K	80		NL3000039K002
		1288 lm	4000K	80		NL3000039K005
						NL3000039W002
						NL3000039W005
						NL30000ELK002
						NL30000ELK005
						NL30000ELW002
						NL30000ELW005



IP65

220/240Vac 50/60Hz electronic ballast included

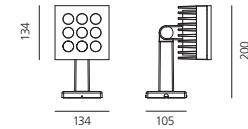

22 W	4000 K	$\alpha=6^\circ$	22 W	4000 K	$\alpha=40^\circ$	22 W	4000 K	$\alpha=54^\circ \times 6^\circ$			
H m	\varnothing m	EMax lux	EM lux	H m	\varnothing m	EMax lux	EM lux	H m	\varnothing m	EMax lux	EM lux
1	0,09	74555	47384	1	0,71	2429	1525	1	1,04	6575	4085
2	0,19	18639	11846	2	1,42	607	381	2	2,07	1644	1021
3	0,28	8284	5265	3	2,14	270	169	3	3,11	731	454
4	0,37	4660	2962	4	2,85	152	95	4	4,15	411	255
5	0,47	2982	1895	5	3,56	97	61	5	5,18	263	163

— C = 0°-180° Cd/Klm
 C = 90°-270°

Falange 18

W	Beam	Flux	CCT	CRI	Color	Code
44 W	6°	2462 lm	3000 K	80		NL3000110K002
		2647 lm	4000 K	80		NL3000110K005
	40°	2374 lm	3000K	80		NL3000110W002
		2553 lm	4000K	80		NL3000110W005
	54°x6°	2397 lm	3000K	80		NL3000139K002
		2577 lm	4000K	80		NL3000139K005
						NL3000139W002
						NL3000139W005
						NL30001ELK002
						NL30001ELK005
						NL30001ELW002
						NL30001ELW005



IP65

220/240Vac 50/60Hz electronic ballast included

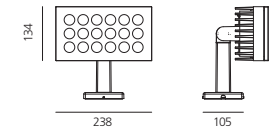

44 W	4000 K	$\alpha=6^\circ$	44 W	4000 K	$\alpha=40^\circ$	44 W	4000 K	$\alpha=54^\circ \times 6^\circ$			
H m	\varnothing m	EMax lux	EM lux	H m	\varnothing m	EMax lux	EM lux	H m	\varnothing m	EMax lux	EM lux
1	0,09	149109	94768	1	0,71	4858	3051	1	1,04	13149	8171
2	0,19	37277	23692	2	1,42	1214	763	2	2,07	3287	2043
3	0,28	16568	10530	3	2,14	540	339	3	3,11	1461	908
4	0,37	9319	5923	4	2,85	304	191	4	4,15	822	511
5	0,47	5964	3791	5	3,56	194	122	5	5,18	526	327

— C = 0°-180° Cd/Klm
 C = 90°-270°

Obice

Alessandro Pedretti
(Studio Rota & Partners)
2014



- Lights fixture with high-performance LED light sources.
- Wall installation.
- Consist of: body, adjustable joint, terminal board and protective screen.
- Body in injection mould of aluminium.
- Terminal base and adjustable joint in injection mould of aluminium.
- Flange, protection screen in tempered glass, 4mm-thick, with black opal serigraphy.
- 24Vdc remote driver.
- White monochromatic LEDs available in 2 colour temperatures:
Warm = 3000K
Neutral = 4000K
- Tilting angle +35°-125°
- Rotation on horizontal axis: 359°.
- Wiring to be carried out by means of a plug (IP68) located in the terminal base.
- IP Rating IP65.
- Insulation class I (Obice), insulation class III (Obice mini).
- Technical features of light fixtures in compliance with EN60598-1.
- Installation must be carried out by specialized personnel.
- Carefully follow the instructions.



Obice						
W	Beam	CRI	Flux	CCT	Color	Code
10 W	18°	80	670 lm	3000 K	●	T430518W10
			720 lm	4000 K	○	T430518W20
	34°	80	605 lm	3000 K	●	T430518N10
			650 lm	4000 K	○	T430518N20
			605 lm	3000 K	●	T430534W10
			650 lm	4000 K	○	T430534W20
					●	T430534N10
					○	T430534N20



IP65 IK06 ⊕

220/240Vac 50/60Hz electronic ballast included

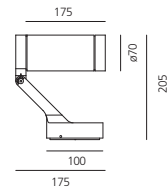
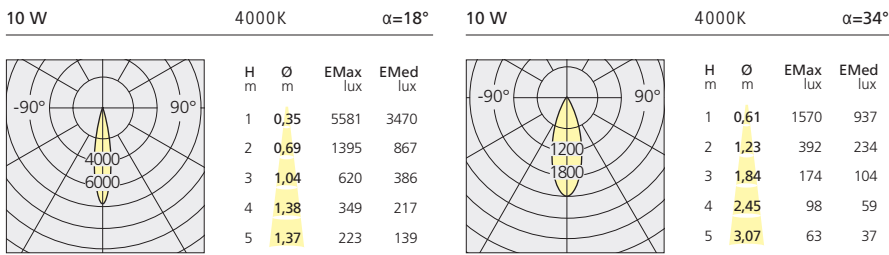

Obice Mini						
W	Beam	CRI	Flux	CCT	Color	Code
7 W	18°	80	505 lm	3000 K	●	T430418W10
			540 lm	4000 K	○	T430418W20
	34°	80	460 lm	3000 K	●	T430418N10
			495 lm	4000 K	○	T430418N20
			460 lm	3000 K	●	T430434W10
			495 lm	4000 K	○	T430434W20
					●	T430434N10
					○	T430434N20



IP65 IK06 ⊕

Driver 24Vdc SELV supplied separately

Driver	Vac	L _{mm}	W _{mm}	H _{mm}	IP	Code
cv 12 W 24Vdc	220-240	145	65	55	65	1max NL11027
cv 40 W 24Vdc	220-240	139	65	50	67	3max NL62040
cv 70 W 24Vdc	220-240	182	42	18	67	8max NL89080
cv 150 W 24Vdc	220-240	235	66	51	67	18max NL62880

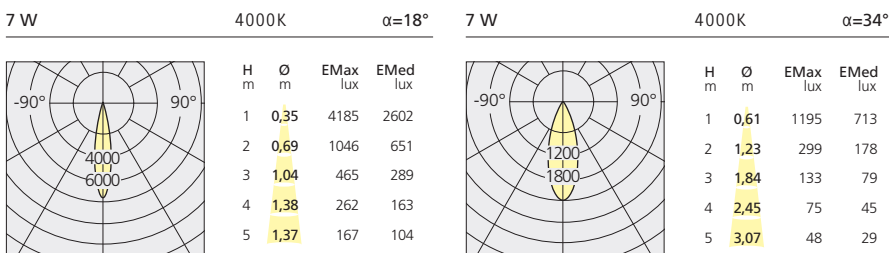
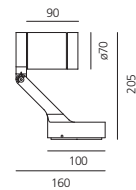

Accessories		Color	Code
	Accessories holder	○	T430600020
		●	T430600010
	Lens for elliptical emission		T430700000



CARIDDI 30 / CARIDDI 40
OPTICS 12°



CARIDDI 30
OPTICS 16° - 35°

CARIDDI 40
OPTICS 17° - 36°



- Monochromatic LED projector.
- Floor, wall, ceiling, eaves installation.
- Consists of an adjustable lighting unit and terminal board. Rotation on the base +/-180°, body tilting +/-130. Positioning is maintained by means of locking dowels.
- The base and the lighting unit are connected by a H05RN-F cable.
- EN AB47100 aluminium head and terminal board, EN AW6060 aluminium body, silicone gaskets.
- Electronic ballast integrated in the body.
- Silicone-sealed silk-screened tempered glass.
- Wiring to be performed inside the terminal board by piercing an IP65 grommet suitable for 8-12mm diameter cables.
- LED COB with PMMA lens and anodized aluminium reflector in 3 different beam versions.
- Available in 2 different powers.
- All the screws used outside the product are in AISI 316 stainless steel.
- All the components in die-cast aluminium are painted with 3-stage outdoor treatment: nanotechnologies, anti-oxidizing primer, polyester paint.
- Technical features of the light fixtures in compliance with EN60598-1 and section 2-5.
- IP Rating IP65
- Insulation class I

Cariddi

Anthracite grey



Cariddi 30

W	LED	COB	CRI	Beam	CCT	Flux	Color	Code
27 W			80	12°	3000 K	229 lm	●	T418610W00
					4000 K	246 lm	●	T418610N00
				16°	3000 K	1638 lm	●	T418620W00
					4000 K	1753 lm	●	T418620N00
				35°	3000 K	1468 lm	●	T418640W00
					4000 K	1571 lm	●	T418640N00

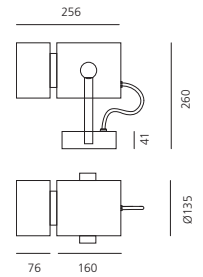

220/240Vac 50/60Hz electronic ballast included

IP65 IK07

27 W

4000 K

$\alpha=12^\circ$

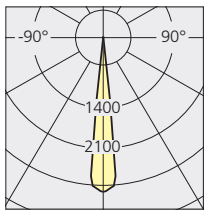

H	Ø	E _{Max}	E _{Med}
1	0,20	7114	5216
2	0,41	1778	1304
3	0,61	790	580
4	0,82	445	326
5	1,02	285	209

$\alpha=11,6^\circ$

— C = 0°-180° Cd/Klm
..... C = 90°-270°

27 W

4000 K

$\alpha=16^\circ$

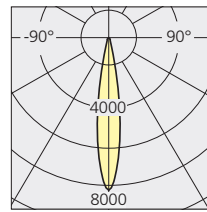

H	Ø	E _{Max}	E _{Med}
1	0,28	14345	9130
2	0,55	3586	2283
3	0,83	1594	1014
4	1,11	897	571
5	1,38	574	365

$\alpha=15,8^\circ$

— C = 0°-180° Cd/Klm
..... C = 90°-270°

27 W

4000 K

$\alpha=35^\circ$

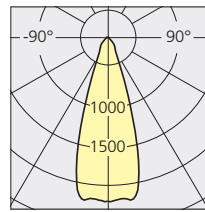

H	Ø	E _{Max}	E _{Med}
1	0,62	3602	2409
2	1,25	900	602
3	1,87	400	268
4	2,49	225	151
5	3,11	144	96

$\alpha=34,6^\circ$

— C = 0°-180° Cd/Klm
..... C = 90°-270°

Cariddi 40

W	LED	COB	CRI	Beam	CCT	Flux	Color	Code
40 W			80	12°	3000 K	356 lm	●	T418710W00
					4000 K	356 lm	●	T418710N00
				17°	3000 K	2322 lm	●	T418720W00
					4000 K	2322 lm	●	T418720N00
				36°	3000 K	2405 lm	●	T418740W00
					4000 K	2405 lm	●	T418740N00

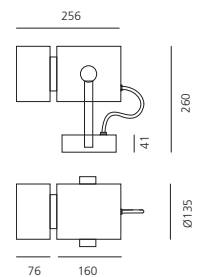

220/240Vac 50/60Hz electronic ballast included

IP65 IK07

40 W

4000 K

$\alpha=12^\circ$

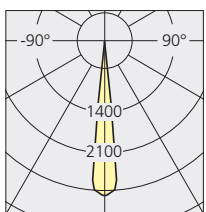

H	Ø	E _{Max}	E _{Med}
1	0,20	10295	7549
2	0,41	2574	1887
3	0,61	1144	839
4	0,82	643	472
5	1,02	412	302

$\alpha=11,6^\circ$

— C = 0°-180° Cd/Klm
..... C = 90°-270°

40 W

4000 K

$\alpha=17^\circ$

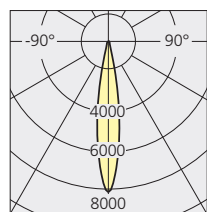

H	Ø	E _{Max}	E _{Med}
1	0,30	18876	11802
2	0,59	4719	2950
3	0,89	2097	1311
4	1,18	1180	738
5	1,48	755	472

$\alpha=16,8^\circ$

— C = 0°-180° Cd/Klm
..... C = 90°-270°

40 W

4000 K

$\alpha=36^\circ$

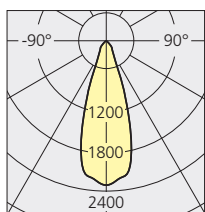

H	Ø	E _{Max}	E _{Med}
1	0,66	5249	3357
2	1,32	1312	839
3	1,98	583	373
4	2,63	328	210
5	3,29	210	134

$\alpha=36,8^\circ$

— C = 0°-180° Cd/Klm
..... C = 90°-270°



- Light fixture with direct emission, with monochromatic LED light sources.
- Floor, wall, eaves installation.
- Consists of lighting unit, wiring terminal board and fixing plate. Rotation on the base $\pm 10^\circ$, body tilting $\pm 80^\circ$. Positioning is maintained by means of locking dowels.
- EN AB47100 aluminium body and terminal board, silicone gaskets. Electronic ballast integrated in the body.
- Polycarbonate diffuser silicone-sealed to the lens supporting unit.
- Composed by 3 interchangeable optical units.
- IP67 connector for the electrical connection to the mains, which can be located in the base compartment and is suitable for 5-13.5mm diameter cables.
- LED circuits with PMMA lenses in 3 beam versions: 9° , 24° and elliptical $12 \times 40^\circ$
- All the screws used outside the product are in AISI 316 stainless steel.
- All the components in die-cast aluminium are painted with 3-stage outdoor treatment: nanotechnologies, anti-oxidizing primer, polyester paint.
- Technical features of the lighting fixtures in compliance with EN60598-1 and section 2-5.
- IP Rating IP66.
- Protection level from 4KV impulse overvoltage.
- Insulation class II.

Sostituto Spot

Anthracite grey

W	CCT	CRI	Flux	Beam	Color	Code
105 W	4000 K	80	7526 lm	9°	●	T418410N00
			7600 lm	24°	●	T418423N00
			7207 lm	12x40°	●	T4184ELN00



IP65 IK10

220/240Vac 50/60Hz electronic ballast included

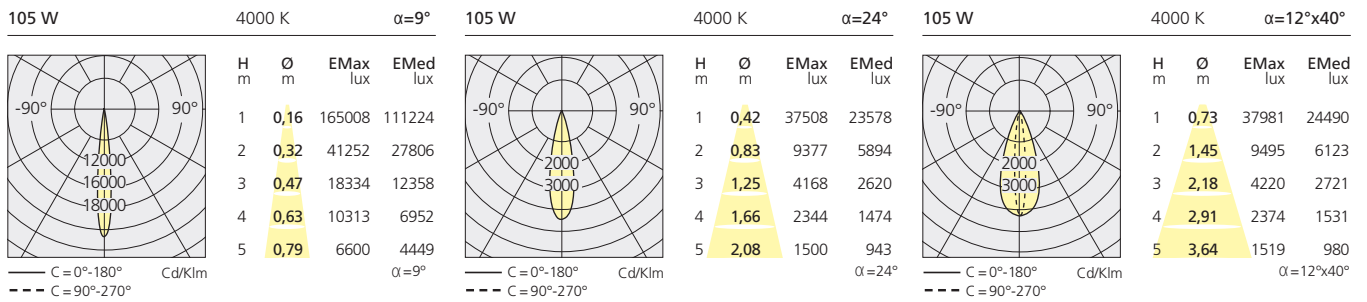
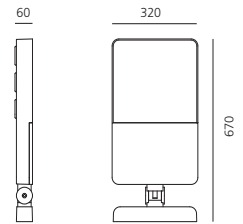

Spot optic

Concentrated luminous flow to highlight details avoiding unwanted light dispersion. 9° optic

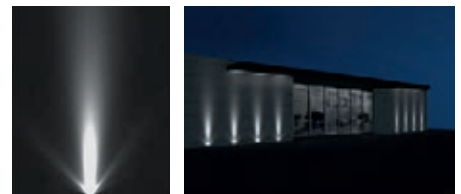

Flood optic

Wide luminous flow suitable for lighting large areas. 24° optic

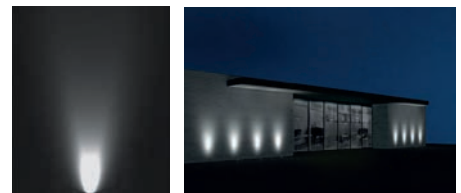

Wall Washer optic

Elliptical distribution of the luminous flow suitable for wall washer effect. 12°x40° optic

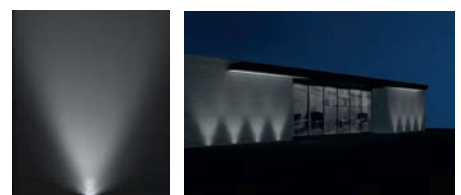



- Light fixture with adjustable direct emission, with high-performance LED light sources.
- Floor, wall and eaves installation.
- 2 sizes: Cefiso 14, Cefiso 20.
- Available in two finishes: grey-white painted and anthracite grey painted.
- Consists of adjustable lighting unit and terminal board. Rotation on the base $\pm 180^\circ$, body tilting $\pm 90^\circ$ by means of a graduated metal ring allowing an accurate adjustment. Positioning is maintained by means of locking dowels.
- Body and terminal board in EN AB44100 aluminium, silicone gaskets.
- Electronic ballast integrated in the body.
- Silkscreened tempered glass siliconed flush with the body to avoid backwater.
- Wiring to be carried out inside the terminal board by piercing an IP65 grommet suitable for cables with a diameter of 8-13 mm.
- PMMA lenses in 3 different versions of beams.
- White monochromatic LEDs available in 2 colour temperatures:
Warm = 3000K
Neutral = 4000K
- Screws in AISI 316 stainless steel.
- Painted die-cast aluminium with 3-stage outdoor treatment: nanotechnologies, antioxidant primer, polyester paint.
- Technical features of light fixtures in compliance with EN60598-1 and part 2-5.
- IP Rating IP65.
- ENEC approved.
- Insulation class I.



red dot design award
2012



Spot optic

Concentrated luminous flow to highlight details avoiding unwanted light dispersion.
6° optic



Flood optic

Wide luminous flow suitable for lighting large areas.
40° optic

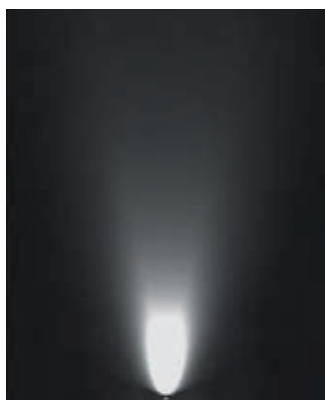

Wall Washer optic

Elliptical distribution of the luminous flow suitable for wall washer effect.
34°x6° optic

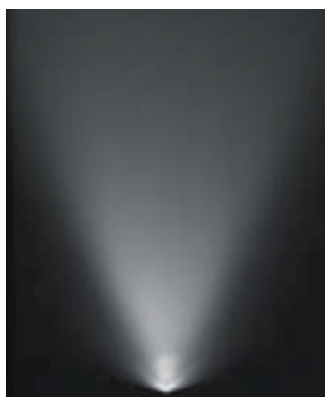



Cefiso 14

W	Beam	CRI	Flux	CCT	Color	Code
22 W	6°	80	1231 lm	3000 K	○	T418010W00
			1323 lm	4000K	●	T418010W10
	40°	80	1187 lm	3000K	○	T418010N00
			1276 lm	4000K	●	T418010N10
	34°x6°	80	1198 lm	3000K	○	T418039W00
			1288 lm	4000K	●	T418039W10
				○	T418039N00	
				●	T418039N10	
				○	T4180ELW00	
				●	T4180ELW10	
				○	T4180ELN00	
				●	T4180ELN10	



IP65 IK10

220/240Vac 50/60Hz electronic ballast included

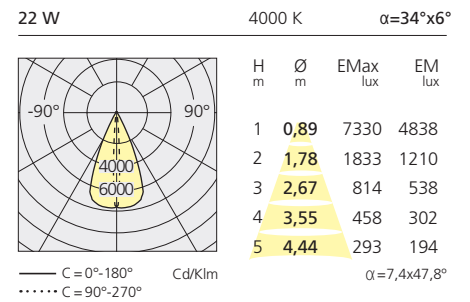
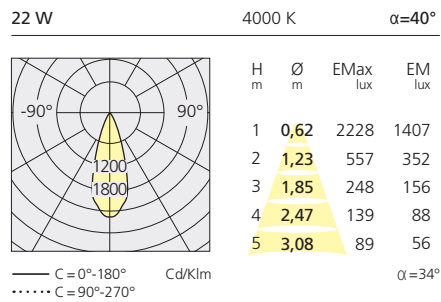
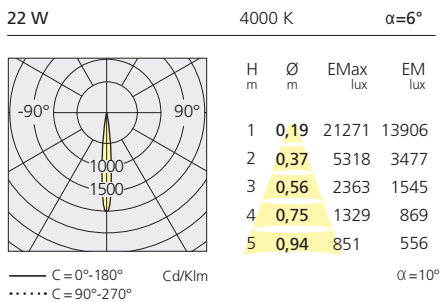
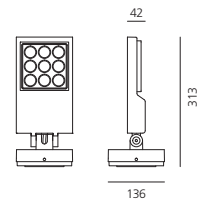

Cefiso 20

W	Beam	CRI	Flux	CCT	Color	Code
37 W	6°	80	2188 lm	3000 K	○	T418110W00
			2353 lm	4000K	○	T418110W10
					●	T418110N00
	40°	80	2110 lm	3000K	○	T418139W00
			2269 lm	4000K	○	T418139W10
					●	T418139N00
34°x6°	80	2136 lm	3000K	○	T4181ELW00	
		2297 lm	4000K	○	T4181ELW10	
				●	T4181ELN00	
					●	T4181ELN10



IP65 IK10

220/240Vac 50/60Hz electronic ballast included

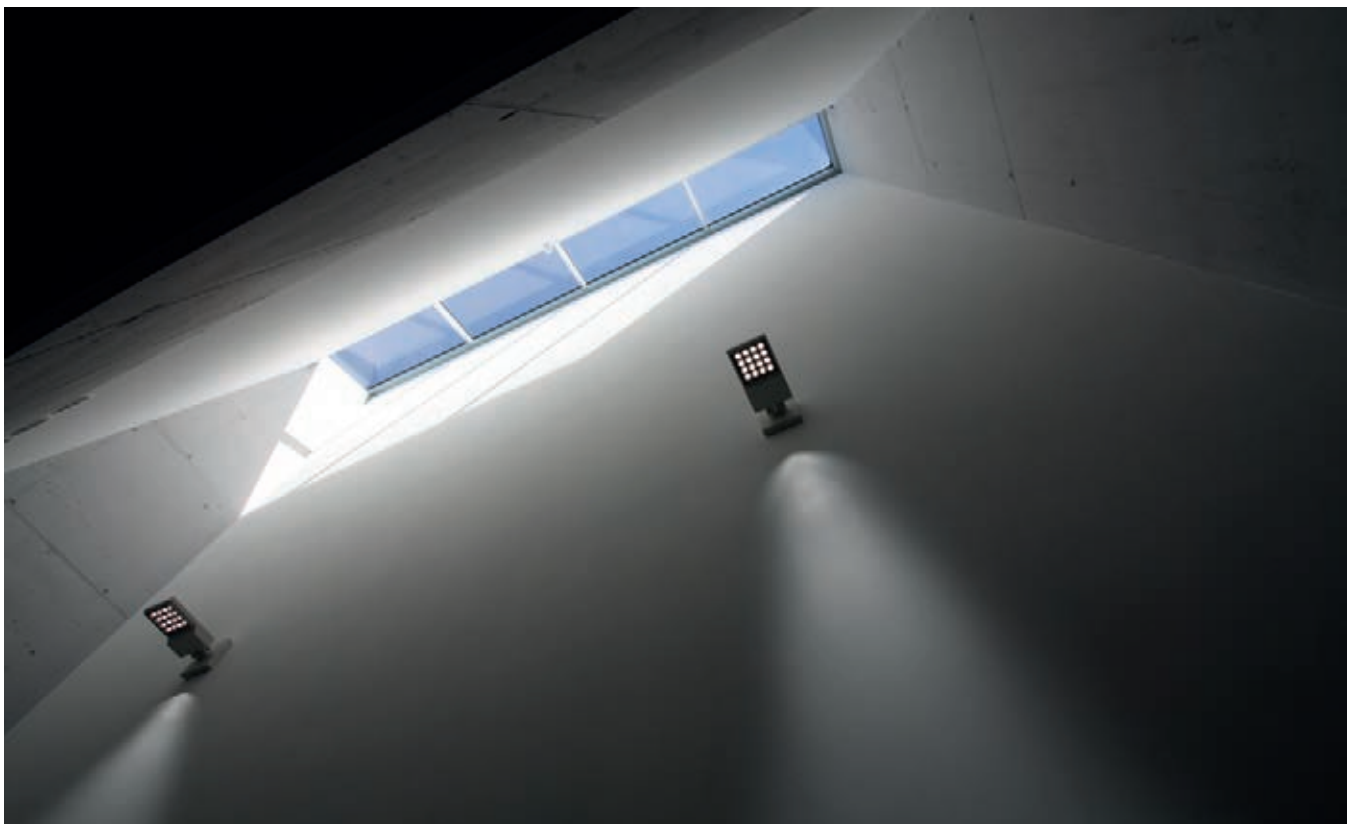
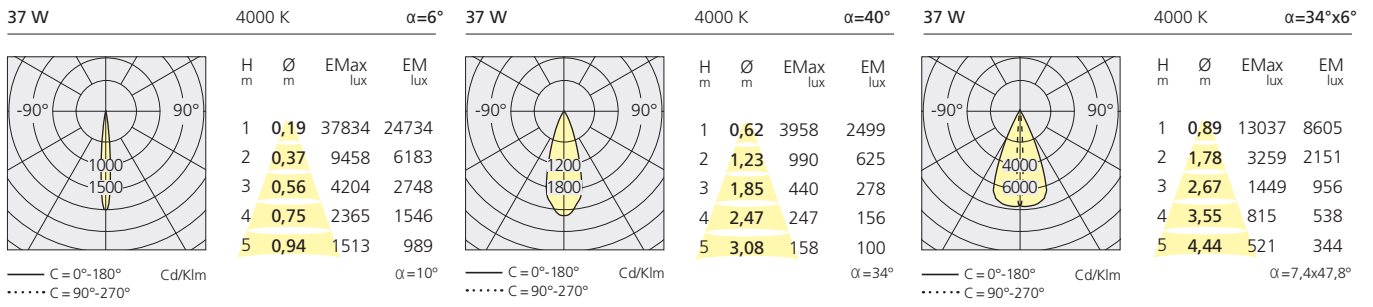
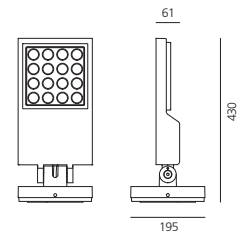

Artemide



IP65/67

Downlighting
Walk-over/Drive-over Lighting
Indicator Lighting

690	Ego downlight
710	Ego walk-over / drive-over
726	Megara
734	Microled
738	Aria
742	Faci
752	Percorso

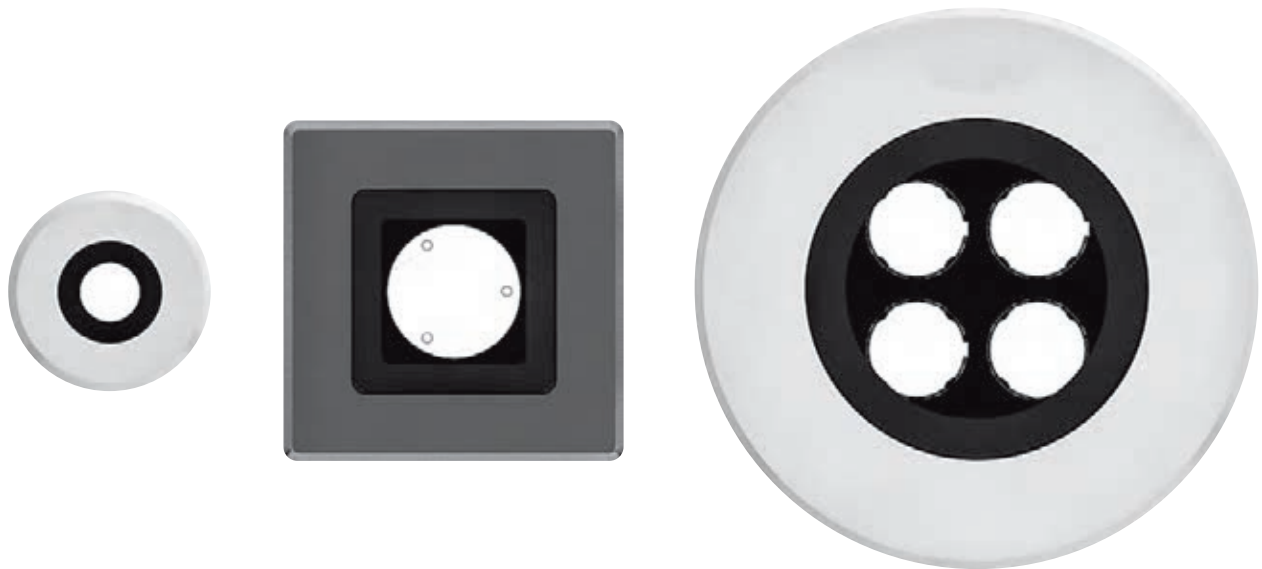

- Light fixture with high-performance LED light sources.
- Ceiling installation.
- Two different housing depths.
- Round and square version in five sizes.
- Consists of body, frame, black silkscreened tempered glass, fixing springs.
- Body in EN AB44100 aluminium, silicone gaskets.
- Frame in aluminium or stainless steel AISI 316.
- Black silkscreened tempered glass, 8mm-thick.
- Fixing springs in harmonic iron.
- Power connection to the mains by means of a H05RN-r cable and IP68 electrical terminal board, supplied with the fixture.

- Glass surface temperature lower than 40°C.
- Fixed and adjustable optics. PMMA lenses in 3 different versions of beams.
- White monochromatic LEDs available in 2 colour temperatures:
Warm = 3000K
Neutral = 4000K
- Painted die-cast aluminium with 3-stage outdoor treatment: nanotechnologies, anti-oxidant primer, polyester paint.
- Technical features of light fixtures in compliance with EN60598-1 and part 2-13.
- IP Rating IP65.
- Insulation class III (Ego 55-90, Ego Flat).
Insulation class I (Ego).

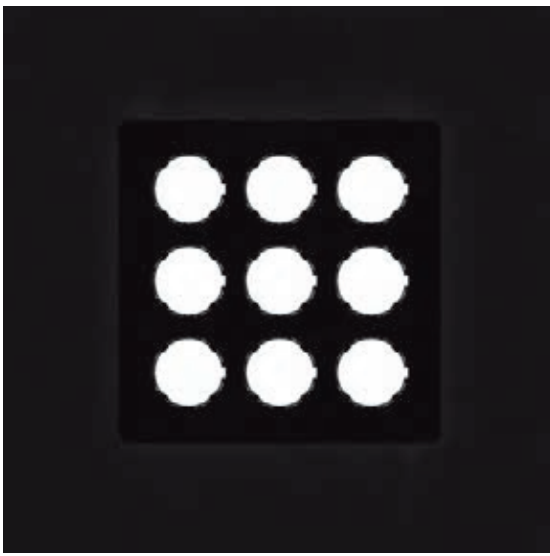

Ego downlight



Ego 55 downlight
Recessed depth 94 mm



Ego 90 downlight
Recessed depth 90 mm

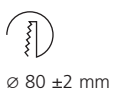

Ego 150 downlight
Recessed depth 120 mm

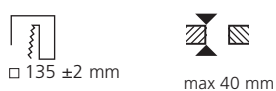

Ego 55 downlight
Recessed depth 60 mm

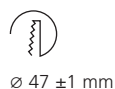

Ego 90 downlight
Recessed depth 60 mm

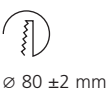

Ego 150 downlight
Recessed depth 60 mm

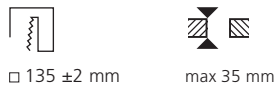
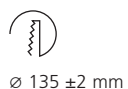

Remote ballast
supplied separately.
(Ego Flat, Ego 55-90)

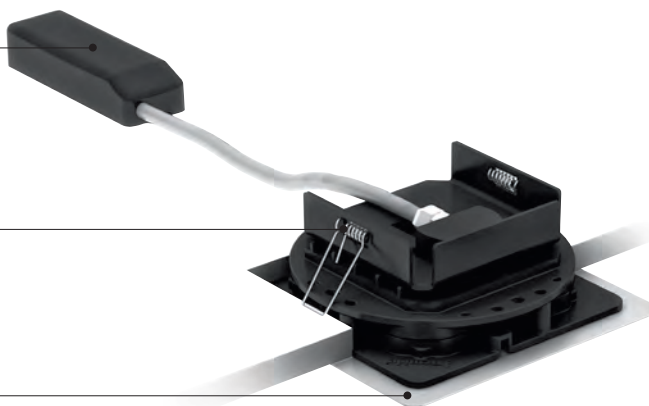

Lighting unit
with built-in springs.

Round or square frame in aluminium
or stainless steel.
Silkscreened tempered glass.



Ego 220 downlight
Recessed depth 117 mm



∅ 203 ±2 mm



□ 203 ±2 mm



max 40 mm

Ego 320 downlight
Recessed depth 116 mm



∅ 300 ±2 mm



□ 300 ±2 mm



max 40 mm

Ego 220 downlight
Recessed depth 60 mm



∅ 203 ±2 mm



□ 203 ±2 mm



max 35 mm

Spot



Medium flood

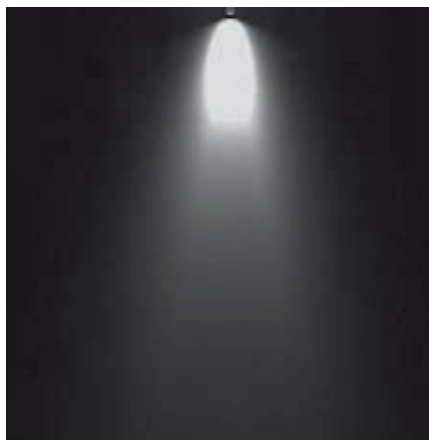

Wall Washer







Ego 55 downlight round

W	Beam	Flux	CRI	CCT
1,5 W	14°	83 lm	80	3000K
		88 lm	80	4000K
	32°	76 lm	80	3000K
		88 lm	80	4000K
	16°x34°	78 lm	80	3000K
		82 lm	80	4000K

Aluminium IK09
Code
T4081SPW00
T4081SPN00
T4081WFLW00
T4081WFLN00
T4081ELPTW00
T4081ELPTN00

Stainless steel IK10
Code
T4080SPW00
T4080SPN00
T4080WFLW00
T4080WFLN00
T4080ELPTW00
T4080ELPTN00

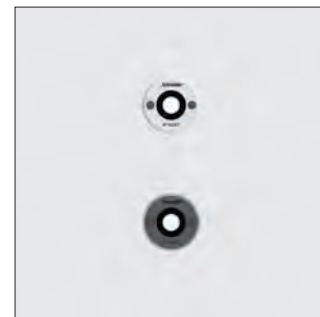

IP65/ IP67

∅ 47±1

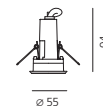

max 35 mm



Fixed beam

Electronic ballast 24V SELV supplied separately

Driver 25 W	T409996
Driver 60 W	T409998
Driver 90 W	T409999

Please see page 875 for drivers installation details.

Ego 55 Flat downlight round

W	Weight	Beam	Flux	CRI	CCT
1 W	0,60 kg	14°	83 lm	80	3000K
			88 lm	80	4000K
		32°	76 lm	80	3000K
			88 lm	80	4000K
		16°x34°	78 lm	80	3000K
			82 lm	80	4000K

Aluminium IK09
Code
T42001SPW00
T42001SPN00
T42001WFLW00
T42001WFLN00
T42001ELPTW00
T42001ELPTN00

Stainless steel IK10
Code
T42009SPW00
T42009SPN00
T42009WFLW00
T42009WFLN00
T42009ELPTW00
T42009ELPTN00

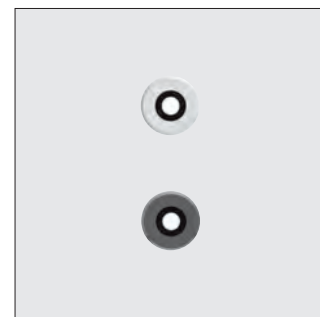

IP65/IP67

∅ 47±1



max 40 mm



Fixed beam

Electronic ballast 24V SELV supplied separately

Driver 6 W	350mA	IP67	4 max	NL11022
Driver 11 W	350mA	IP67	3 min - 9 max	NL19019

Please see page 875 for drivers installation details.

1,5 W 4000 K α=14°

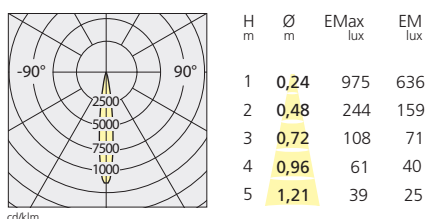

1,5 W 3000 K α=32°

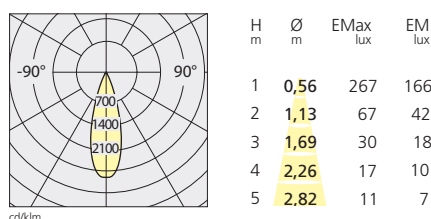

1,5 W 4000 K α=16°x34°

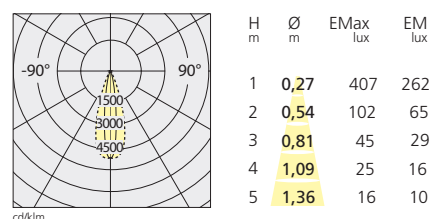

--- C0 - C180
 C90 - C270

Ego 55 downlight square

W	Beam	Flux	CRI	CCT
1,5 W	14°	83 lm	80	3000K
		88 lm	80	4000K
	32°	76 lm	80	3000K
		88 lm	80	4000K
	16°x34°	78 lm	80	3000K
		82 lm	80	4000K

Aluminium IK09	
Code	
T4061SPW00	
T4061SPN00	
T4061WFLW00	
T4061WFLN00	
T4061ELPTW00	
T4061ELPTN00	

Stainless steel IK10	
Code	
T4060SPW00	
T4060SPN00	
T4060WFLW00	
T4060WFLN00	
T4060ELPTW00	
T4060ELPTN00	

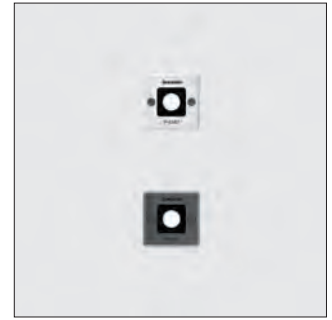

Electronic ballast 24V SELV supplied separately

Driver 25 W	T409996
Driver 60 W	T409998
Driver 90 W	T409999

Please see page 875 for drivers installation details.

IP65/ IP67 $\varnothing 47 \pm 1$

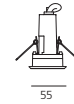

max 35 mm



Fixed beam

Ego 55 Flat downlight square

W	Weight	Beam	Flux	CRI	CCT
1 W	0,60 kg	14°	83 lm	80	3000K
			88 lm	80	4000K
		32°	76 lm	80	3000K
			88 lm	80	4000K
		16°x34°	78 lm	80	3000K
			82 lm	80	4000K

Aluminium IK09	
Code	
T42002SPW00	
T42002SPN00	
T42002WFLW00	
T42002WFLN00	
T42002ELPTW00	
T42002ELPTN00	

Stainless steel IK10	
Code	
T42010SPW00	
T42010SPN00	
T42010WFLW00	
T42010WFLN00	
T42010ELPTW00	
T42010ELPTN00	

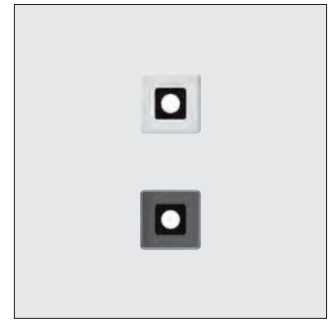

Electronic ballast 24V SELV supplied separately

Driver 6 W	350mA	IP67	3 max	NL11022
Driver 11 W	350mA	IP67	3 min - 9 max	NL19019

Please see page 875 for drivers installation details.

IP65/ IP67 $\varnothing 47 \pm 1$



max 40 mm



Fixed beam

1 W 4000 K $\alpha=14^\circ$

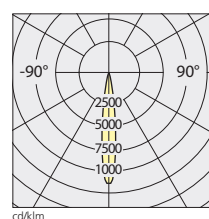

H m	\varnothing m	EMax lux	EM lux
1	0,24	975	636
2	0,48	244	159
3	0,72	108	71
4	0,96	61	40
5	1,21	39	25

1 W 4000 K $\alpha=32^\circ$

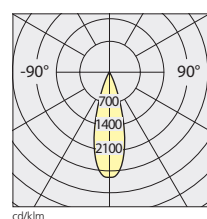

H m	\varnothing m	EMax lux	EM lux
1	0,56	267	166
2	1,13	67	42
3	1,69	30	18
4	2,26	17	10
5	2,82	11	7

1 W 4000 K $\alpha=16^\circ \times 34^\circ$

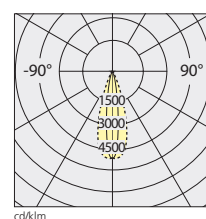

H m	\varnothing m	EMax lux	EM lux
1	0,27	407	262
2	0,54	102	65
3	0,81	45	29
4	1,09	25	16
5	1,36	16	10

cd/klm
 --- C0 - C180
 - - - C90 - C270

Ego 90 downlight round

W	Beam	Flux	CRI	CCT
3 W	10°	220 lm	80	3000K
		233 lm	80	4000K
	24°	179 lm	80	3000K
		190 lm	80	4000K
	10°x40°	162 lm	80	3000K
		171 lm	80	4000K

Aluminium IK10
Code
T4083SPW00
T4083SPN00
T4083FLW00
T4083FLN00
T4083ELPTW00
T4083ELPTN00

Stainless steel IK10
Code
T4082SPW00
T4082SPN00
T4082FLW00
T4082FLN00
T4082ELPTW00
T4082ELPTN00

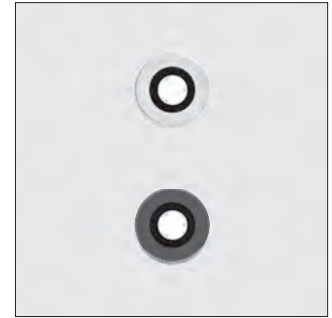

IP65/ IP67 $\varnothing 80 \pm 2$



max 35 mm

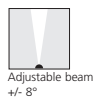

Electronic ballast 24V SELV supplied separately

Driver	25 W	T409996
Driver	60 W	T409998
Driver	90 W	T409999

Please see page 875 for drivers installation details.

Ego 90 Flat downlight round

W	Weight	Beam	Flux	CRI	CCT
3 W	0,60 kg	10°	220 lm	80	3000K
			233 lm	80	4000K
		24°	179 lm	80	3000K
			190 lm	80	4000K
		10°x40°	162 lm	80	3000K
			171 lm	80	4000K

Aluminium IK10
Code
T42003SPW00
T42003SPN00
T42003FLW00
T42003FLN00
T42003ELPTW00
T42003ELPTN00

Stainless steel IK10
Code
T42011SPW00
T42011SPN00
T42011FLW00
T42011FLN00
T42011ELPTW00
T42011ELPTN002

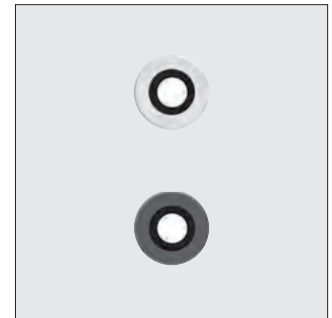

IP65/ IP67 $\varnothing 80 \pm 2$

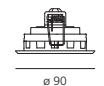

max 35 mm



Electronic ballast 24V SELV supplied separately

Driver	6 W	350mA	IP67	1 max	NL11022
Driver	11 W	350mA	IP67	3 max	NL19019

Please see page 875 for drivers installation details.

3 W 4000 K $\alpha=10^\circ$

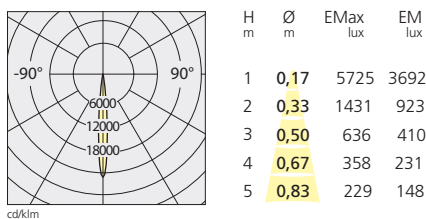

3 W 4000 K $\alpha=24^\circ$

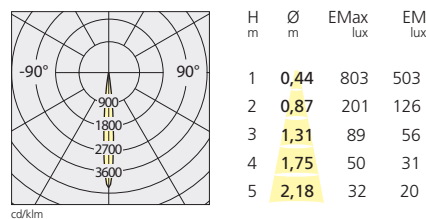

3 W 4000 K $\alpha=10^\circ \times 40^\circ$

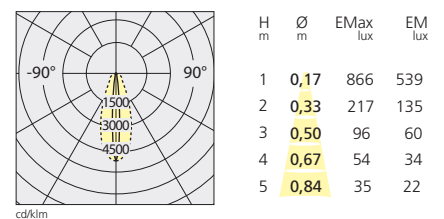

Ego 90 downlight square

W	Beam	Flux	CRI	CCT
3 W	10°	220 lm	80	3000K
		233 lm	80	4000K
	24°	179 lm	80	3000K
		190 lm	80	4000K
	10°x40°	162 lm	80	3000K
		171 lm	80	4000K

Aluminium IK10
Code
T4063SPW00
T4063SPN00
T4063FLW00
T4063FLN00
T4063ELPTW00
T4063ELPTN00

Stainless steel IK10
Code
T4062SPW00
T4062SPN00
T4062FLW00
T4062FLN00
T4062ELPTW00
T4062ELPTN00

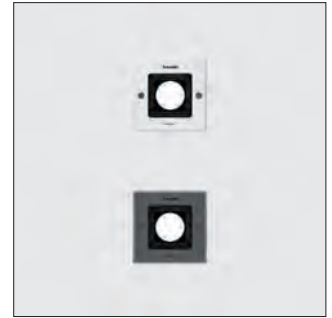

Electronic ballast 24V SELV supplied separately

Driver 25 W	T409996
Driver 60 W	T409998
Driver 90 W	T409999

IP65/ IP67 $\varnothing 47\pm 2$

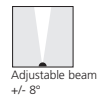

Please see page 875 for drivers installation details.

Ego 90 Flat downlight square

W	Weight	Beam	Flux	CRI	CCT
3 W	0,60 kg	10°	220 lm	80	3000K
			233 lm	80	4000K
		24°	179 lm	80	3000K
			190 lm	80	4000K
		10°x40°	162 lm	80	3000K
			171 lm	80	4000K

Aluminium IK10
Code
T42004SPW00
T42004SPN00
T42004FLW00
T42004FLN00
T42004ELPTW00
T42004ELPTN00

Stainless steel IK10
Code
T42012SPW00
T42012SPN00
T42012FLW00
T42012FLN00
T42012ELPTW00
T42012ELPTN00

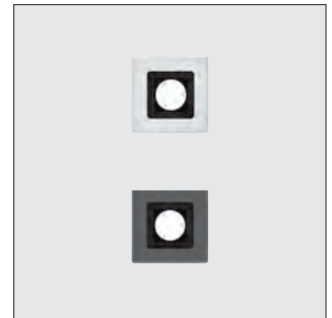

Electronic ballast 24V SELV supplied separately

Driver 6 W	350mA	IP67	1 max	NL11022
Driver 11 W	350mA	IP67	3 max	NL19019

IP65/ IP67 $\varnothing 80\pm 2$

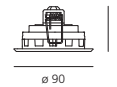

Please see page 875 for drivers installation details.

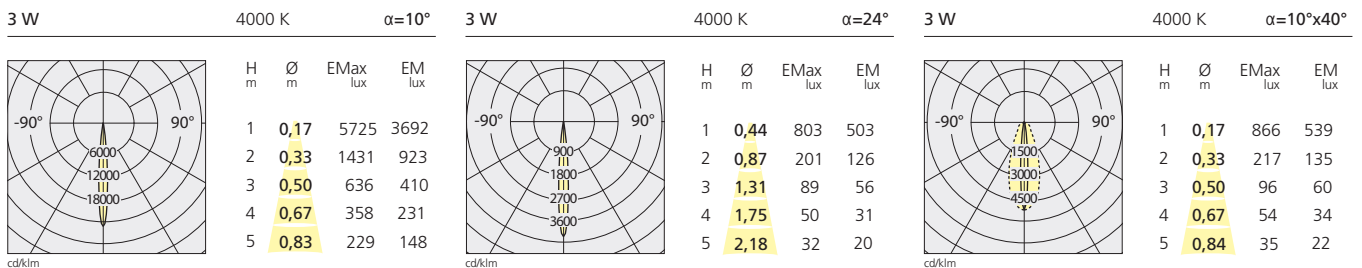

Ego 150 downlight round

					Aluminium IK09	Stainless steel IK09
W	Beam	Flux	CRI	CCT	Code	Code
8 W	5°	366 lm	80	3000K	T4085NSPW00	T4084NSPW00
		392 lm	80	4000K	T4085NSPN00	T4084NSPN00
	38°	321 lm	80	3000K	T4085WFLW00	T4084WFLW00
		344 lm	80	4000K	T4085WFLN00	T4084WFLN00
	6°x54°	366 lm	80	3000K	T4085ELPTW00	T4084ELPTW00
		392 lm	80	4000K	T4085ELPTN00	T4084ELPTN00

220/240Vac 50/60Hz electronic ballast included



IP65/ IP67 \varnothing 135±2

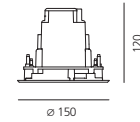

max 40 mm

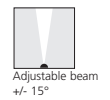

Adjustable beam
+/- 15°

Ego 150 Flat downlight round

						Aluminium IK09	Stainless steel IK09
W	Weight	Beam	Flux	CRI	CCT	Code	Code
6 W	0,60 kg	5°	366 lm	80	3000K	T42005NSPW00	T42013NSPW00
			392 lm	80	4000K	T42005NSPN00	T42013NSPN00
		38°	321 lm	80	3000K	T42005WFLW00	T42013WFLW00
			344 lm	80	4000K	T42005WFLN00	T42013WFLN00
		6°x54°	366 lm	80	3000K	T42005ELPTW00	T42013ELPTW00
			392 lm	80	4000K	T42005ELPTN00	T42013ELPTN00

Electronic ballast 500mA SELV supplied separately

Driver	14 W	500mA	IP67	1 max	NL19046
Driver	20 W	500mA	IP67	2 max	NL19047

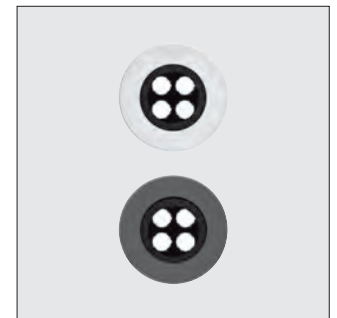

IP65/ IP67 \varnothing 135±2

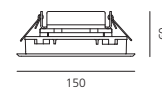

max 35 mm



Fixed beam

8W 4000 K $\alpha=5^\circ$

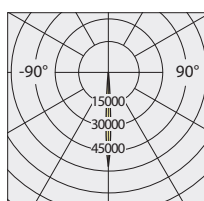

H	\varnothing	EMax	EM
m	m	lux	lux
1	0,10	21441	13555
2	0,19	5360	3389
3	0,29	2382	1506
4	0,39	1340	847
5	0,49	858	542

cd/klm

8 W 4000 K $\alpha=38^\circ$

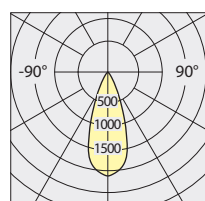

H	\varnothing	EMax	EM
m	m	lux	lux
1	0,69	721	447
2	1,39	180	112
3	2,08	80	50
4	2,77	45	28
5	3,47	29	18

cd/klm

8 W 4000 K $\alpha=6^\circ \times 54^\circ$

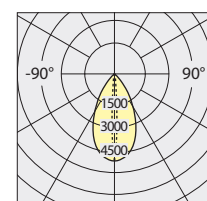

H	\varnothing	EMax	EM
m	m	lux	lux
1	1,04	2000	1243
2	2,07	500	311
3	3,11	222	138
4	4,15	125	78
5	5,18	80	50

cd/klm

— C0 - C180
..... C90 - C270

Ego 150 downlight square

W	Beam	Flux	CRI	CCT
8 W	5°	366 lm	80	3000K
		392 lm	80	4000K
	38°	321 lm	80	3000K
		344 lm	80	4000K
	6°x54°	366 lm	80	3000K
		392 lm	80	4000K

Aluminium IK09
Code
T4065NSPW00
T4065NSPN00
T4065WFLW00
T4065WFLN00
T4065ELPTW00
T40615ELPTN00

Stainless steel IK09
Code
T4064NSPW00
T4064NSPN00
T4064WFLW00
T4064WFLN00
T4064ELPTW00
T4064ELPTN00

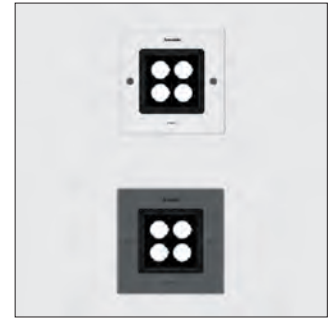

IP65/ IP67

135 x 135±2

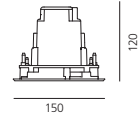

max 40 mm



220/240Vac 50/60Hz electronic ballast included

Ego 150 Flat downlight square

W	Weight	Beam	Flux	CRI	CCT
6 W	0,60 kg	5°	366 lm	80	3000K
			392 lm	80	4000K
		38°	321 lm	80	3000K
			344 lm	80	4000K
		6°x54°	366 lm	80	3000K
			392 lm	80	4000K

Aluminium IK09
Code
T42006NSPW00
T42006NSPN00
T42006WFLW00
T42006WFLN00
T42006ELPTW00
T42006ELPTN00

Stainless steel IK09
Code
T42014NSPW00
T42014NSPN00
T42014WFLW00
T42014WFLN00
T42014ELPTW00
T42014ELPTN00

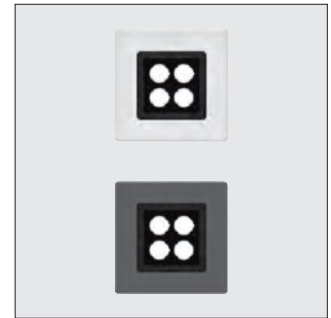

IP65/ IP67

135 x 135±2

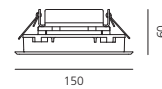

max 35 mm



Electronic ballast 500mA SELV supplied separately

Driver	14 W	500mA	IP67	1 max
Driver	20 W	500mA	IP67	2 max

NL19046
NL19047

6 W 4000 K α=5°

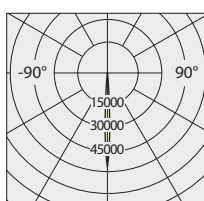

cd/klm

H m	Ø m	EMax lux	EM lux
1	0,10	21441	13555
2	0,19	5360	3389
3	0,29	2382	1506
4	0,39	1340	847
5	0,49	858	542

6 W 4000 K α=38°

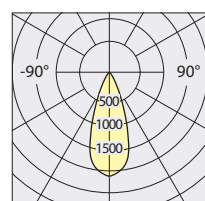

cd/klm

H m	Ø m	EMax lux	EM lux
1	0,69	721	447
2	1,39	180	112
3	2,08	80	50
4	2,77	45	28
5	3,47	29	18

6 W 4000 K α=6°x54°

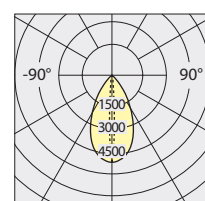

cd/klm

H m	Ø m	EMax lux	EM lux
1	1,04	2000	1243
2	2,07	500	311
3	3,11	222	138
4	4,15	125	78
5	5,18	80	50

— C0 - C180
 C90 - C270

Ego 220 downlight round

W	Beam	Flux	CRI	CCT
16 W	5°	787 lm	80	3000K
		842 lm	80	4000K
	38°	794 lm	80	3000K
		850 lm	80	4000K
	6°x54°	797 lm	80	3000K
		853 lm	80	4000K

Aluminium IK10

Code
T4087NSPW00
T4087NSPN00
T4087WFLW00
T4087WFLN00
T4087ELPTW00
T4087ELPTN00

Stainless steel IK10

Code
T4086NSPW00
T4086NSPN00
T4086WFLW00
T4086WFLN00
T4086ELPTW00
T4086ELPTN00

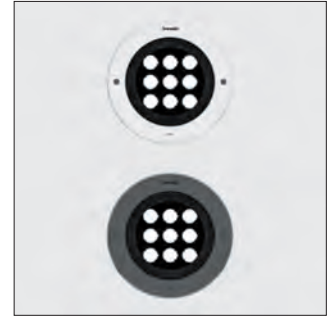

IP65/ IP67 \varnothing 203±2

220/240Vac 50/60Hz electronic ballast included

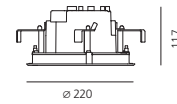

max 40 mm

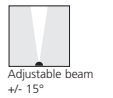

Adjustable beam
+/- 15°

Ego 220 Flat downlight round

W	Weight	Beam	Flux	CRI	CCT
14 W	0,60 kg	5°	787 lm	80	3000K
			842 lm	80	4000K
		38°	794 lm	80	3000K
			850 lm	80	4000K
		6°x54°	797 lm	80	3000K
			853 lm	80	4000K

Aluminium IK10

Code
T42007NSPW00
T42007NSPN00
T42007WFLW00
T42007WFLN00
T42007ELPTW00
T42007ELPTN00

Stainless steel IK10

Code
T42015NSPW00
T42015NSPN00
T42015WFLW00
T42015WFLN00
T42015ELPTW00
T42015ELPTN00

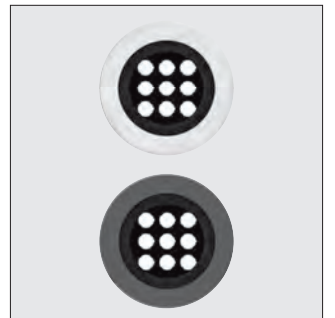

IP65/ IP67 IK10 \varnothing 203±2

Electronic ballast 500mA SELV supplied separately

Driver 20 W 500mA IP67 1 max

NL19047

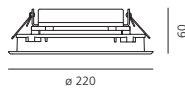

max 35 mm

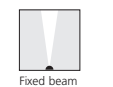

Fixed beam

16 W 4000 K $\alpha=5^\circ$

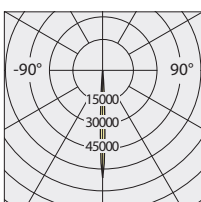

H m	\varnothing m	EMax lux	EM lux
1	0,08	55272	35006
2	0,17	13818	8752
3	0,25	6141	3890
4	0,34	3455	2188
5	0,42	2211	1400

16 W 3000 K $\alpha=38^\circ$

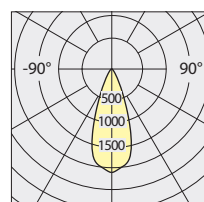

H m	\varnothing m	EMax lux	EM lux
1	0,69	1818	1138
2	1,38	454	284
3	2,06	202	126
4	2,75	114	71
5	3,44	73	46

16 W 4000 K $\alpha=6 \times 54^\circ$

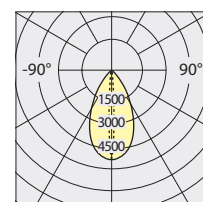

H m	\varnothing m	EMax lux	EM lux
1	1,04	4352	2705
2	2,07	1088	676
3	3,11	484	301
4	4,15	272	169
5	5,18	174	108

— C0 - C180
- - - C90 - C270

Ego 220 downlight square

					Aluminium IK10		Stainless steel IK10	
W	Beam	Flux	CRI	CCT	Code		Code	
16 W	5°	787 lm	80	3000K	T4067NSPW00	T4066NSPW00	T4066NSPW00	T4066NSPW00
		842 lm	80	4000K	T4067NSPN00	T4066NSPN00	T4066NSPN00	T4066NSPN00
	38°	794 lm	80	3000K	T4067WFLW00	T4066WFLW00	T4066WFLW00	T4066WFLW00
		850 lm	80	4000K	T4067WFLN00	T4066WFLN00	T4066WFLN00	T4066WFLN00
	6°x54°	797 lm	80	3000K	T4067ELPTW00	T4066ELPTW00	T4066ELPTW00	T4066ELPTW00
		853 lm	80	4000K	T4067ELPTN00	T4066ELPTN00	T4066ELPTN00	T4066ELPTN00

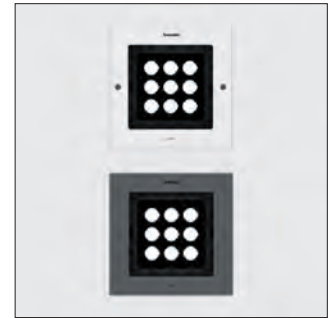

IP65/ IP67

203 x 203±2

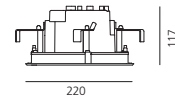

max 40 mm

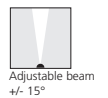

220/240Vac 50/60Hz electronic ballast included

Ego 220 Flat downlight square

						Aluminium IK10		Stainless steel IK10	
W	Weight	Beam	Flux	CRI	CCT	Code		Code	
14 W	0,60 kg	5°	787 lm	80	3000K	T42008NSPW00	T42016NSPW00	T42016NSPW00	T42016NSPW00
			842 lm	80	4000K	T42008NSPN00	T42016NSPN00	T42016NSPN00	T42016NSPN00
		38°	794 lm	80	3000K	T42008WFLW00	T42016WFLW00	T42016WFLW00	T42016WFLW00
			850 lm	80	4000K	T42008WFLN00	T42016WFLN00	T42016WFLN00	T42016WFLN00
		6°x54°	797 lm	80	3000K	T42008ELPTW00	T42016ELPTW00	T42016ELPTW00	T42016ELPTW00
			853 lm	80	4000K	T42008ELPTN00	T42016ELPTN00	T42016ELPTN00	T42016ELPTN00

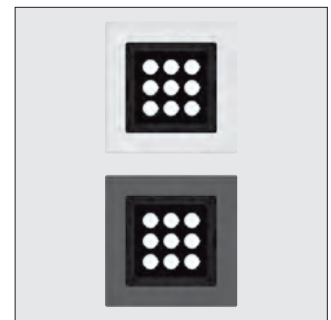

IP65/IP67 IK10

203 x 203±2

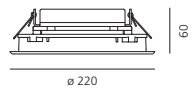

max 35 mm



Electronic ballast 500mA SELV supplied separately

Driver 20 W 500mA IP67 1 max

NL19047

14 W	4000 K	α=5°	14 W	4000 K	α=38°	14 W	4000 K	α=6x54°			
H m	Ø m	EMax lux	EM lux	H m	Ø m	EMax lux	EM lux	H m	Ø m	EMax lux	EM lux
1	0,08	55272	35006	1	0,69	1818	1138	1	1,04	4352	2705
2	0,17	13818	8752	2	1,38	454	284	2	2,07	1088	676
3	0,25	6141	3890	3	2,06	202	126	3	3,11	484	301
4	0,34	3455	2188	4	2,75	114	71	4	4,15	272	169
5	0,42	2211	1400	5	3,44	73	46	5	5,18	174	108

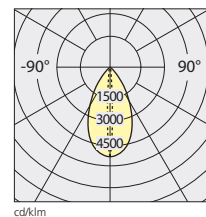
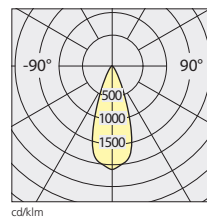
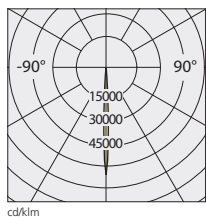

— C0 - C180
..... C90 - C270

Ego 320 downlight round

					Aluminium IK10	Stainless steel IK10
W	Beam	Flux	CRI	CCT	Code	Code
27 W	5°	1550 lm	80	3000K	T4093NSPW00	T4092NSPW00
		1659 lm	80	4000K	T4093NSPN00	T4092NSPN00
	38°	1530 lm	80	3000K	T4093WFLW00	T4092WFLW00
		1637 lm	80	4000K	T4093WFLN00	T4092WFLN00
	6°x54°	1534 lm	80	3000K	T4093ELPTW00	T4092ELPTW00
		1641 lm	80	4000K	T4093ELPTN00	T4092ELPTN00



IP65/ IP67 \varnothing 300±2

220/240Vac 50/60Hz electronic ballast included

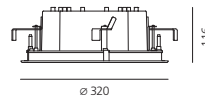

Ego 320 downlight round

					Aluminium IK10	Stainless steel IK10
W	Beam	Flux	CRI	CCT	Code	Code
27 W	5°	1550 lm	80	3000K	T4073NSPW00	T4072NSPW00
		1659 lm	80	4000K	T4073NSPN00	T4072NSPN00
	38°	1530 lm	80	3000K	T4073WFLW00	T4072WFLW00
		1637 lm	80	4000K	T4073WFLN00	T4072WFLN00
	6°x54°	1534 lm	80	3000K	T4073ELPTW00	T4072ELPTW00
		1641 lm	80	4000K	T4073ELPTN00	T4072ELPTN00

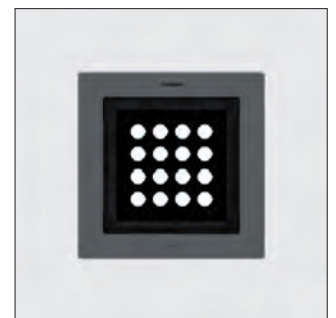

IP65/ IP67 300 x 300±2

220/240Vac 50/60Hz electronic ballast included

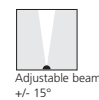
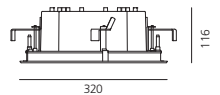

27 W	4000 K	$\alpha=6^\circ$	27 W	3000 K	$\alpha=38^\circ$	27 W	4000 K	$\alpha=6^\circ \times 54^\circ$			
H	\varnothing	EMax	EM	H	\varnothing	EMax	EM	H	\varnothing	EMax	EM
m	m	lux	lux	m	m	lux	lux	m	m	lux	lux
1	0,09	95555	60440	1	0,70	3294	2064	1	1,04	8373	5203
2	0,19	23889	15110	2	1,41	823	516	2	2,07	2093	1301
3	0,28	10617	6716	3	2,11	366	229	3	3,11	930	578
4	0,38	5972	3778	4	2,81	206	129	4	4,15	523	325
5	0,47	3822	2418	5	3,52	132	83	5	5,18	335	208

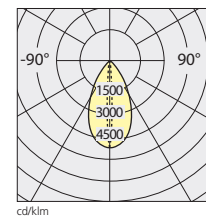
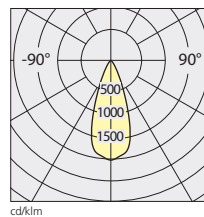
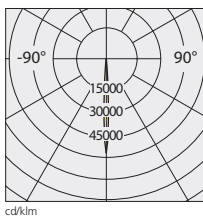

..... C0 - C180
 C90 - C270

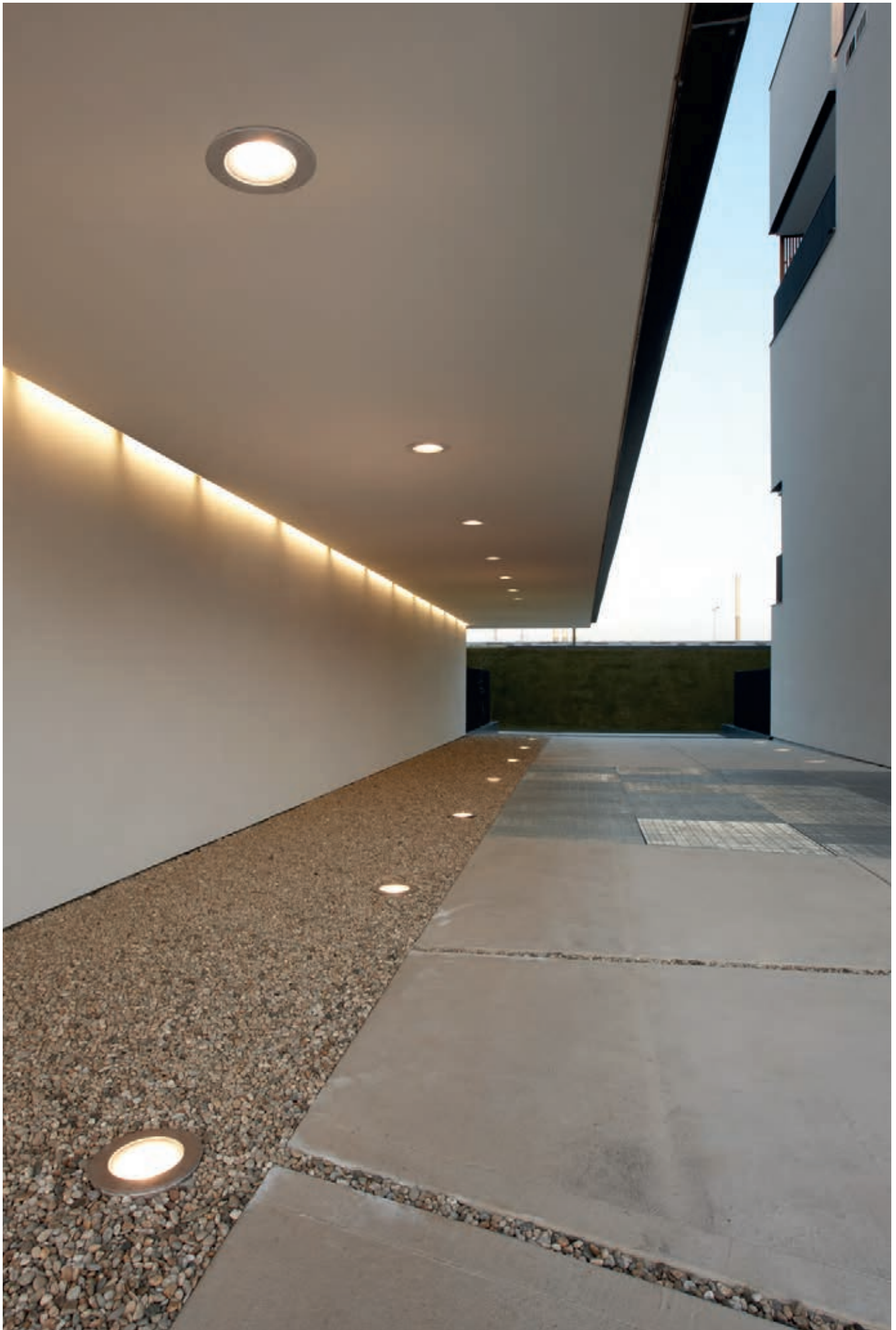



Spot optic

Concentrated luminous flow to highlight details avoiding unwanted light dispersion.

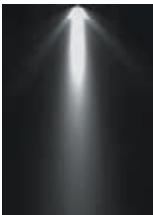

Flood optic

Wide luminous flow suitable for lighting large areas.



Wall Washer optic

Elliptical distribution of the luminous flow suitable for wall washer effect.

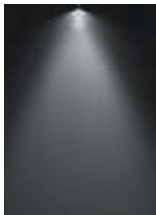

Ego 150 glass downlight

					Round	Square
W	Beam	Flux	CRI	CCT	Code	Code
8 W	5°	366 lm	80	3000K	T4130NSPW00	T4120NSPW00
		392 lm	80	4000K	T4130NSPN00	T4120NSPN00
	38°	321 lm	80	3000K	T4130WFLW00	T4120WFLW00
		344 lm	80	4000K	T4130WFLN00	T4120WFLN00
	6°x54°	366 lm	80	3000K	T4130ELPTW00	T4120ELPTW00
		392 lm	80	4000K	T4130ELPTN00	T4120ELPTN00
220/240Vac 50/60Hz electronic ballast included						
Plate for plasterboard					T409919	T409920

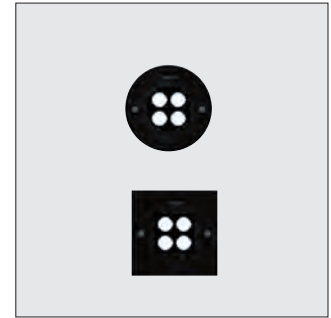

IP65/ IP67 IK09

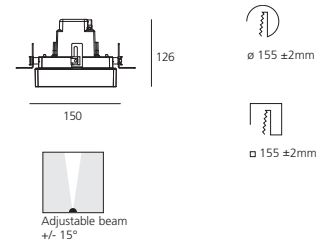

Ego 150 Flat glass downlight

					Round	Square
W	Beam	Flux	CRI	CCT	Code	Code
6 W	5°	366 lm	80	3000K	T42017NSPW00	T42018NSPW00
		392 lm	80	4000K	T42017NSPN00	T42018NSPN00
	38°	321 lm	80	3000K	T42017WFLW00	T42018WFLW00
		344 lm	80	4000K	T42017WFLN00	T42018WFLN00
	6°x54°	366 lm	80	3000K	T42017ELPTW00	T42018ELPTW00
		392 lm	80	4000K	T42017ELPTN00	T42018ELPTN00
Electronic ballast 500mA supplied separately						
Driver	14W	500mA	IP67	1 max	NL19046	
Driver	20W	500mA	IP67	2 min - 2 max	NL19047	

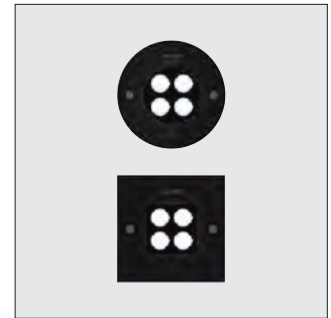

IP65/ IP67 IK09

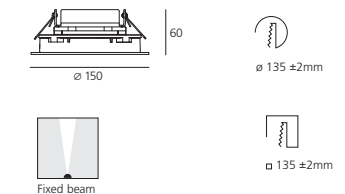

Electronic ballast 500mA SELV supplied separately

8 W	4000 K	$\alpha=5^\circ$	8 W	3000 K	$\alpha=38^\circ$	8 W	4000 K	$\alpha=6^\circ \times 54^\circ$						
	H	\varnothing	EMax	EM	H	\varnothing	EMax	EM						
	m	m	lux	lux	m	m	lux	lux						
	1	0,10	21441	13555		1	0,69	721	447		1	1,04	2000	1243
	2	0,19	5360	3389		2	1,39	180	112		2	2,07	500	311
	3	0,29	2382	1506		3	2,08	80	50		3	3,11	222	138
	4	0,39	1340	847		4	2,77	45	28		4	4,15	125	78
	5	0,49	858	542		5	3,47	29	18		5	5,18	80	50

Ego 220 glass downlight

					Round	Square
W	Beam	Flux	CRI	CCT	Code	Code
16 W	5°	787 lm	80	3000K	T4131NSPW00	T4121NSPW00
		842 lm	80	4000K	T4131NSPN00	T4121NSPN00
	38°	794 lm	80	3000K	T4131WFLW00	T4121WFLW00
		850 lm	80	4000K	T4131WFLN00	T4121WFLN00
	6°x54°	797 lm	80	3000K	T4131ELPTW00	T4121ELPTW00
		853 lm	80	4000K	T4131ELPTN00	T4121ELPTN00

220/240Vac 50/60Hz electronic ballast included

Plate for plasterboard	T409917	T409918
------------------------	---------	---------

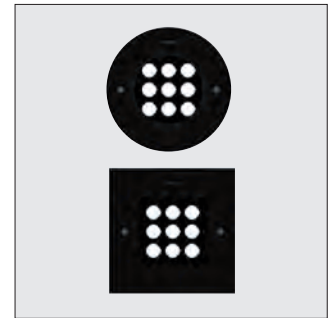

IP65/ IP67 IK09

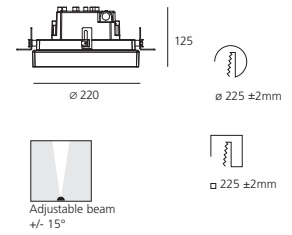

Ego 220 Flat glass downlight

					Round	Square
W	Beam	Flux	CRI	CCT	Code	Code
14 W	4°	787 lm	80	3000K	T42019NSPW00	T42020NSPW00
		842 lm	80	4000K	T42019NSPN00	T42020NSPN00
	38°	794 lm	80	3000K	T42019WFLW00	T42020WFLW00
		850 lm	80	4000K	T42019WFLN00	T42020WFLN00
	6°x54°	797 lm	80	3000K	T42019ELPTW00	T42020ELPTW00
		853 lm	80	4000K	T42019ELPTN00	T42020ELPTN00

Electronic ballast 500mA SELV supplied separately

Driver	20W	500mA	IP67	2 min	NL19047
--------	-----	-------	------	-------	---------

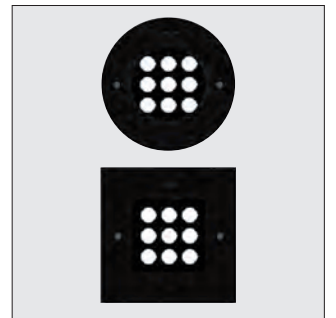

IP65/ IP67 IK09

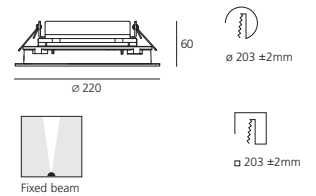

16 W	4000 K	$\alpha=5^\circ$	16 W	3000 K	$\alpha=38^\circ$	16 W	4000 K	$\alpha=6 \times 54^\circ$			
cd/klm			cd/klm			cd/klm					
H	Ø	EMax	EM	H	Ø	EMax	EM	H	Ø	EMax	EM
m	m	lux	lux	m	m	lux	lux	m	m	lux	lux
1	0,08	55272	35006	1	0,69	1818	1138	1	1,04	4352	2705
2	0,17	13818	8752	2	1,38	454	284	2	2,07	1088	676
3	0,25	6141	3890	3	2,06	202	126	3	3,11	484	301
4	0,34	3455	2188	4	2,75	114	71	4	4,15	272	169
5	0,42	2211	1400	5	3,44	73	46	5	5,18	174	108

Ego 320 glass downlight

W	Beam	Flux	CRI	CCT
27 W	5°	1550 lm	80	3000K
		1659 lm	80	4000K
	38°	1530 lm	80	3000K
		1637 lm	80	4000K
	6°x54°	1534 lm	80	3000K
		1641 lm	80	4000K

220/240Vac 50/60Hz electronic ballast included

Plate for plasterboard

Round
Code
T4134NSPW00
T4134NSPN00
T4134WFLW00
T4134WFLN00
T4134ELPTW00
T4134ELPTN00

T409915

Square
Code
T4124NSPW00
T4124NSPN00
T4124WFLW00
T4124WFLN00
T4124ELPTW00
T4124ELPTN00

T409916

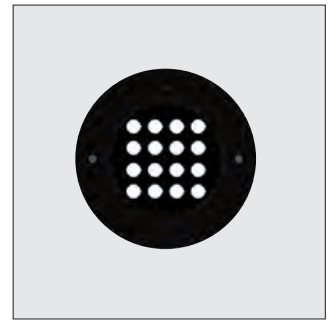

IP65/ IP67 IK09

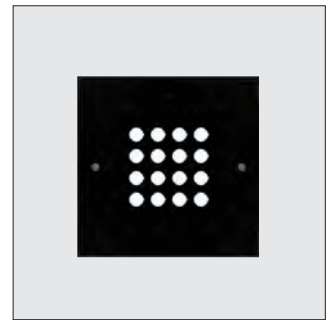
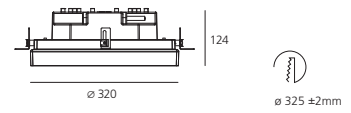

IP65/ IP67 IK09

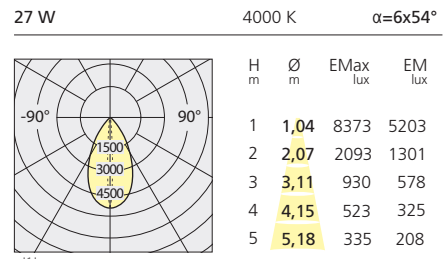
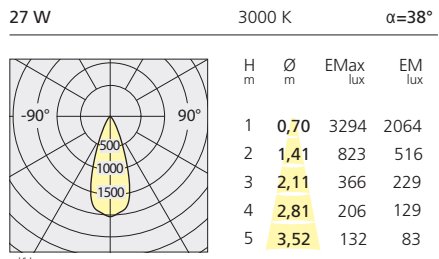
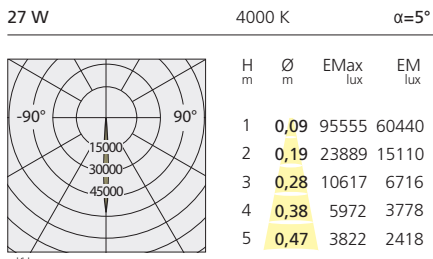
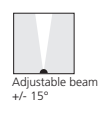
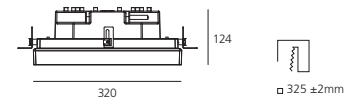

Ego walk-over Ego drive-over

2012



- Light fixture with high-performance LED light sources.
- Recessed ground installation.
- Walk-over and drive-over versions.
- Depth of recess box:
Ego WO: 110-120 mm
Ego Flat WO: 60 mm
- WO/DO round and square version, each one in 5 different sizes.
- Fixture consisting of body, frame, glass diffuser, housing.
- Aluminium body EN AB44100 with silicone gaskets.
- All versions are available with stainless steel frames.
Ego 55-90 / Ego flat 55-90 also available with polished aluminium frame.
Ego 150-220-320 / Ego flat 150-220 also available with 8mm-thick glass flush with the floor.

- Housing in composite techno polymer, to be ordered separately.
- Ego Flat WO H05RNF-F feeding cable length: 300 cm.
Ego WO/DO feeding cable:
H05RNF 2x1 for Ego 55 - 90 ,
H05RNF 3x1 for Ego 150,
H07RNF 3x1 for Ego 220 - 320,
cable length 30 cm.
- All Ego versions (excluding Flat version) are supplied with electronic power supply inside the luminaire body.
- For 55 and 90 versions 24 V power supply and remote power supply to be ordered separately.
- All Ego Flat can be operated by a remote power supply to be ordered separately. Connection cable includes a IP68 electrical terminal board.

- Housing locked by anti-vandal TORX screws in AISI 316 stainless steel.
- Glass surface temperature below 40°C.
- Fixed and adjustable lenses in PMMA in 3 versions with different beam angles.
- White monochromatic LED available in 2 colour temperatures:
Warm = 3000K
Neutral = 4000K
- Die-cast painted aluminium with 3-stage outdoor treatment: nanotechnologies, antioxidant primer, polyester paint.
- Technical features of light fixtures in compliance with EN60598-1 and part 2-13.
- IP rating: IP65-67.
- Insulation class:
Ego WO/DO: class I
(except Ego 55-90 class III)
Ego Flat WO: class III



Ego walk-over Ego drive-over

Ego

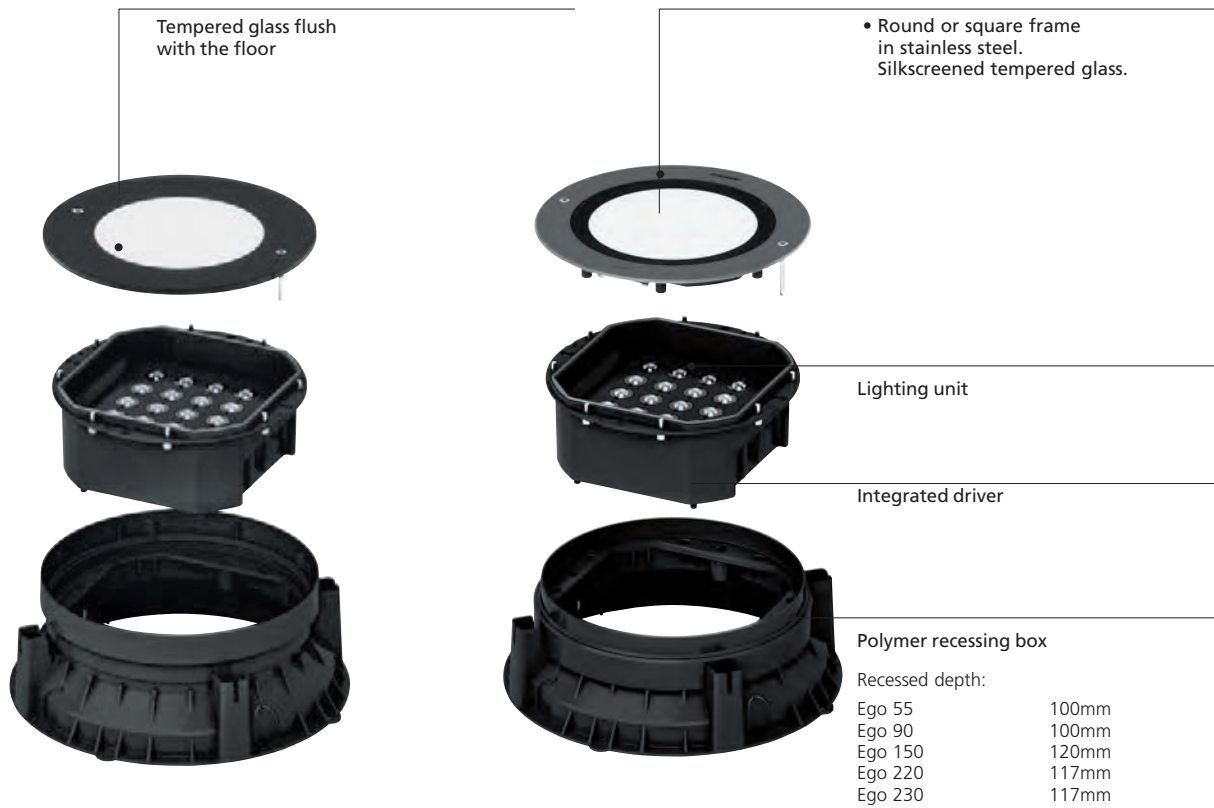

Spot

Concentrated luminous flow to highlight details avoiding unwanted light dispersion.

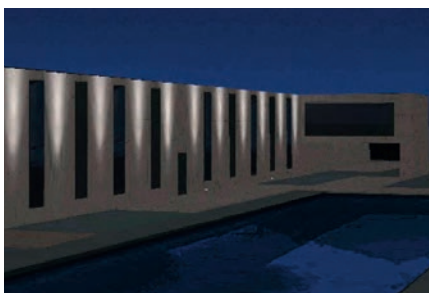

Flood

Wide luminous flow suitable for lighting large areas.



Wall Washer

Elliptical distribution of the luminous flow suitable for wall washer effect.

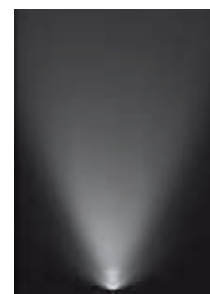

Ego Flat

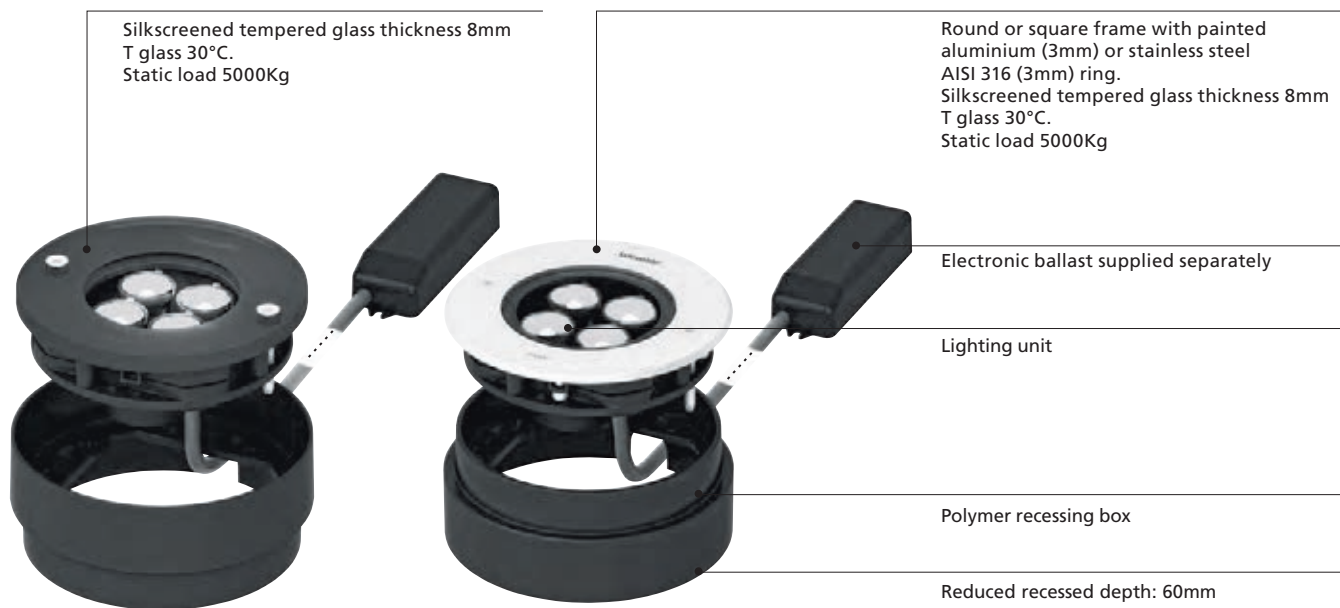

Ego 55 walk-over aluminium

					Round	Square
W	Beam	Flux	CRI	CCT	Code	Code
1,5 W	14°	83 lm	80	3000K	T4031SPW00	T4001SPW00
		88 lm	80	4000K	T4031SPN00	T4001SPN00
	32°	76 lm	80	3000K	T4031WFLW00	T4001WFLW00
		88 lm	80	4000K	T4031WFLN00	T4001WFLN00
	16°x34°	77 lm	80	3000K	T4031ELPTW00	T4001ELPTW00
		82 lm	80	4000K	T4031ELPTN00	T4001ELPTN00

Electronic ballast 24Vdc supplied separately

Recessing box	T409908
Driver 24W	T409996
Driver 60W	T409998
Driver 90W	T409999

Please see page 875 for drivers installation details.

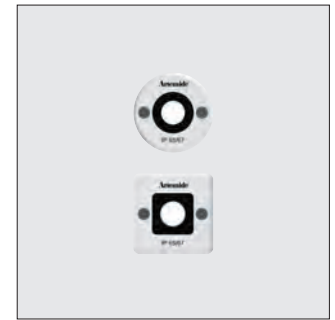

IP65/ IP67 IK09   

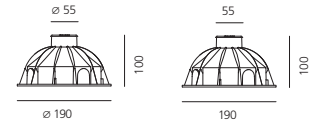

Ego 55 Flat walk-over aluminium

					Round	Square
W	Beam	Flux	CRI	CCT	Code	Code
1 W	14°	83 lm	80	3000K	T40000SPW00	T40001SPW00
		88 lm	80	4000K	T40000SPN00	T40001SPN00
	32°	76 lm	80	3000K	T40000WFLW00	T40001WFLW00
		88 lm	80	4000K	T40000WFLN00	T40001WFLN00
	16°x34°	77 lm	80	3000K	T40000ELPTW00	T40001ELPTW00
		82 lm	80	4000K	T40000ELPTN00	T40001ELPTN00

Electronic ballast 350mA supplied separately

Recessing box	NL40021H0
Driver 6 W 350mA IP67 4 max	NL11022
Driver 11 W 350mA IP67 3 min - 9 max	NL19019

Please see page 875 for drivers installation details.

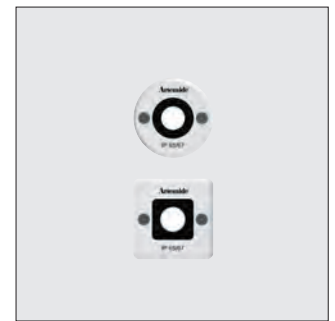

IP65/ IP67 IK09   

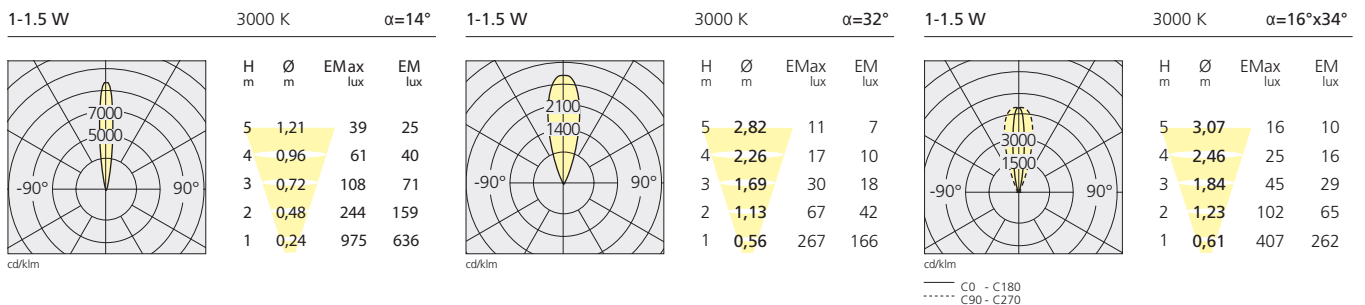
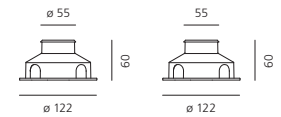

Ego 55 drive-over Stainless steel

W	Beam	Flux	CRI	CCT
1,5 W	14°	83 lm	80	3000K
		88 lm	80	4000K
	32°	76 lm	80	3000K
		88 lm	80	4000K
	16°x34°	77 lm	80	3000K
		82 lm	80	4000K

Electronic ballast 24Vdc supplied separately

Recessing box	
Driver	24W
Driver	60W
Driver	90W

Please see page 875 for drivers installation details.

Round
Code
T4032SPW00
T4032SPN00
T4032WFLW00
T4032WFLN00
T4032ELPTW00
T4032ELPTN00

Square
Code
T4002SPW00
T4002SPN00
T4002WFLW00
T4002WFLN00
T4002ELPTW00
T4002ELPTN00

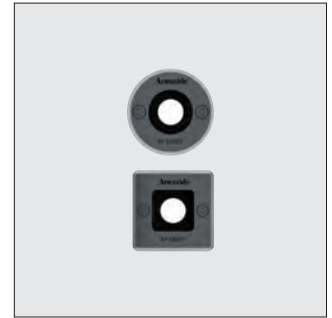

IP65/ IP67 IK10

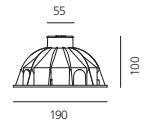
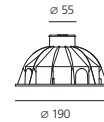

Ego 55 Flat walk-over Stainless steel

W	Beam	Flux	CRI	CCT
1 W	14°	83 lm	80	3000K
		88 lm	80	4000K
	32°	76 lm	80	3000K
		88 lm	80	4000K
	16°x34°	77 lm	80	3000K
		82 lm	80	4000K

Electronic ballast 350mA supplied separately

Recessing box	
Driver	6 W 350mA IP67 4 max
Driver	11 W 350mA IP67 3 min - 9 max

Please see page 875 for drivers installation details.

Round
Code
T40002SPW00
T40002SPN00
T40002WFLW00
T40002WFLN00
T40002ELPTW00
T40002ELPTW00

Square
Code
T40003SPW00
T40003SPN00
T40003WFLW00
T40003WFLN00
T40003ELPTW00
T40003ELPTW00

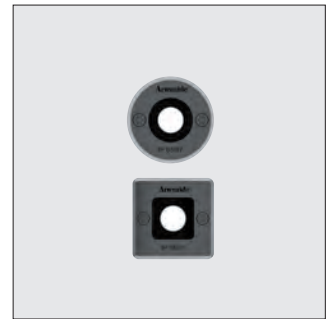

IP65/ IP67 IK09

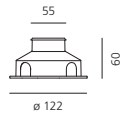
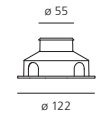

1-1.5 W 3000 K $\alpha=14^\circ$

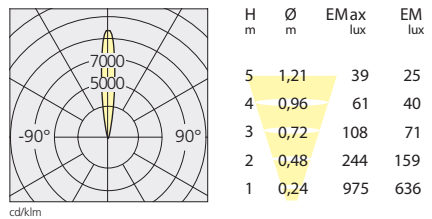

1-1.5 W 3000 K $\alpha=32^\circ$

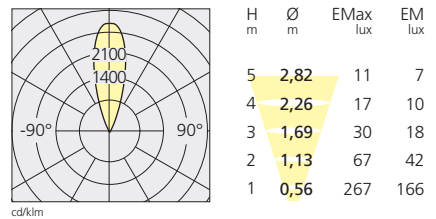

1-1.5 W 3000 K $\alpha=16^\circ \times 34^\circ$

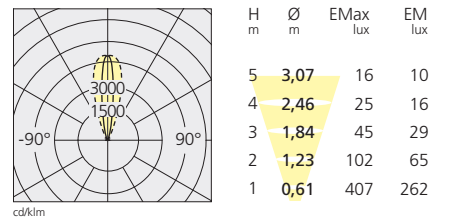

— C0 - C180
- - - C90 - C270

Ego 90 walk-over aluminium

W	Beam	Flux	CRI	CCT
3 W	10°	220 lm	80	3000K
		233 lm	80	4000K
	24°	179 lm	80	3000K
		190 lm	80	4000K
	10°x40°	162 lm	80	3000K
		171 lm	80	4000K

Electronic ballast 24Vdc supplied separately

Recessing box	T409908
Driver 24W	T409996
Driver 60W	T409998
Driver 90W	T409999

Please see page 875 for drivers installation details.

Round
Code
T4034SPW00
T4034SPN00
T4034FLW00
T4034FLN00
T4034ELPTW00
T4034ELPTN00

Square
Code
T4004SPW00
T4004SPN00
T4004FLW00
T4004FLN00
T4004ELPTW00
T4004ELPTN00



IP65/ IP67 IK10   

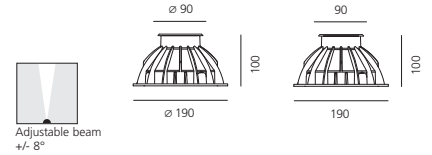

Ego 90 Flat walk-over aluminium

W	Weight	Beam	Flux	CCT	
3 W		10°	220 lm	80	3000K
			233 lm	80	4000K
		24°	179 lm	80	3000K
			190 lm	80	4000K
		10°x40°	162 lm	80	3000K
			171 lm	80	4000K

Electronic ballast 350mA supplied separately

Recessing box	NL40021H0
Driver 6 W	350mA IP67 4 max
Driver 11 W	350mA IP67 3 min - 9 max

Please see page 875 for drivers installation details.

Round
Code
T40004SPW00
T40004SPN00
T40004FLW00
T40004FLN00
T40004ELPTW00
T40004ELPTN00

Square
Code
T40005SPW00
T40005SPN00
T40005FLW00
T40005FLN00
T40005ELPTW00
T40005ELPTN00



IP65/ IP67 IK09   

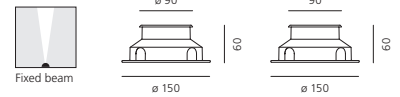

3 W 3000 K $\alpha=10^\circ$

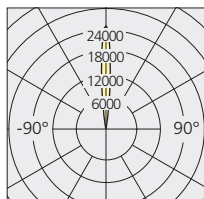

H	Ø	EMax	EM
5	0,83	216	139
4	0,67	338	218
3	0,50	600	387
2	0,33	1351	871
1	0,17	5404	3486

cd/klm

3 W 3000 K $\alpha=24^\circ$

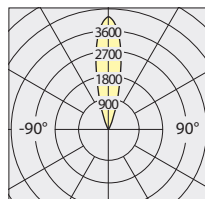

H	Ø	EMax	EM
5	2,18	30	19
4	1,75	47	30
3	1,31	84	53
2	0,87	189	118
1	0,44	756	474

cd/klm

3 W 4000 K $\alpha=10^\circ \times 40^\circ$

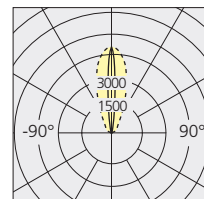

H	Ø	EMax	EM
5	0,84	35	22
4	0,67	54	34
3	0,50	96	60
2	0,33	217	135
1	0,17	866	539

cd/klm

Ego 90 drive-over stainless steel

W	Beam	Flux	CRI	CCT
3 W	10°	220 lm	80	3000K
		233 lm	80	4000K
	24°	179 lm	80	3000K
		190 lm	80	4000K
	10°x40°	162 lm	80	3000K
	171 lm	80	4000K	

Round
Code
T4033SPW00
T4033SPN00
T4033FLW00
T4033FLN00
T4033ELPTW00
T4033ELPTN00

Square
Code
T4003SPW00
T4003SPN00
T4003FLW00
T4003FLN00
T4003ELPTW00
T4003ELPTN00

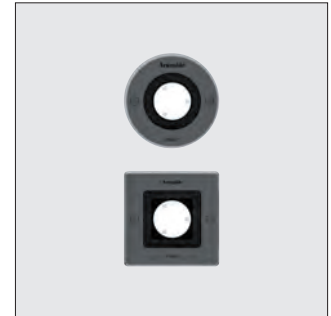

Electronic ballast 24Vdc supplied separately

Recessing box	T409908
Driver 24W	T409996
Driver 60W	T409998
Driver 90W	T409999

Please see page 875 for drivers installation details.

IP65/ IP67 IK10

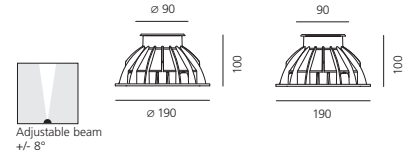

Ego 90 Flat walk-over stainless steel

W	Weight	Beam	Flux	CRI	CCT
3 W	10°	220 lm	80	3000K	
		233 lm	80	4000K	
	24°	179 lm	80	3000K	
		190 lm	80	4000K	
	10°x40°	162 lm	80	3000K	
	171 lm	80	4000K		

Round
Code
T40006SPW00
T40006SPN00
T40006FLW00
T40006FLN00
T40006ELPTW00
T40006ELPTN00

Square
Code
T40007SPW00
T40007SPN00
T40007FLW00
T40007FLN00
T40007ELPTW00
T40007ELPTN00

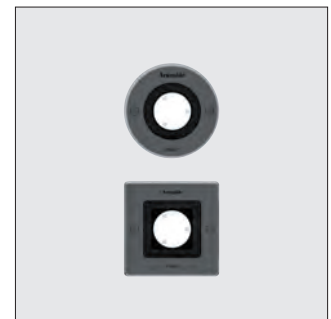

Electronic ballast 350mA supplied separately

Recessing box	NL40021H0
Driver 6 W	350mA IP67 4 max
Driver 11 W	350mA IP67 3 min - 9 max

Please see page 875 for drivers installation details.

IP65/ IP67 IK10

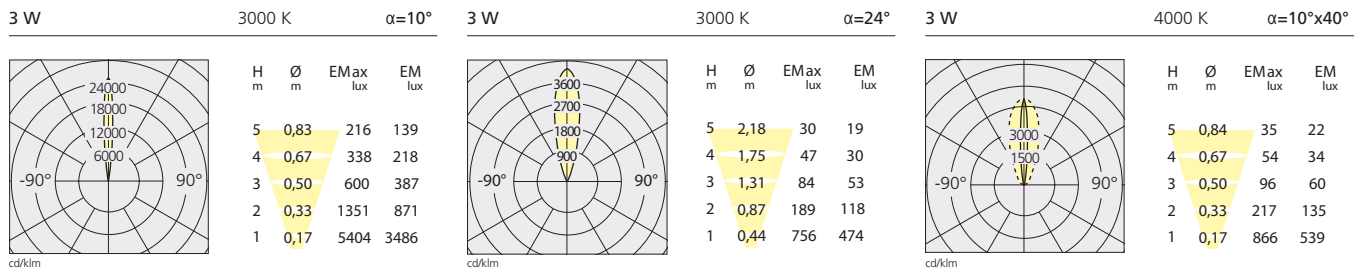
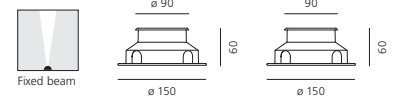

Ego 150 drive-over stainless steel

					Round	Square
W	Beam	Flux	CRI	CCT	Code	Code
8 W	5°	366 lm	80	3000K	T4036NSPW00	T4006NSPW00
		392 lm	80	4000K	T4036NSPN00	T4006NSPN00
	38°	321 lm	80	3000K	T4036WFLW00	T4006WFLW00
		344 lm	80	4000K	T4036WFLN00	T4006WFLN00
	6°x54°	366 lm	80	3000K	T4036ELPTW00	T4006ELPTW00
		392 lm	80	4000K	T4036ELPTN00	T4006ELPTN00
220/240Vac 50/60Hz electronic ballast included						
Recessing box					T409905	T409906

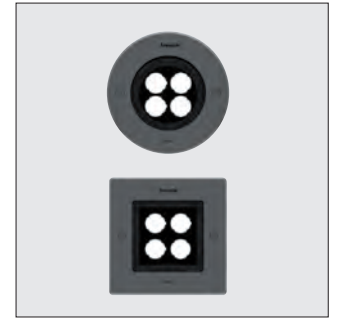

IP65/ IP67 IK09

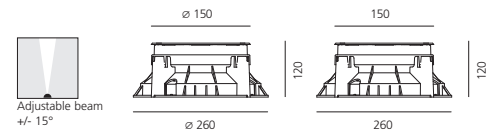

Ego 150 Flat walk-over stainless steel

					Round	Square
W	Beam	Flux	CRI	CCT	Code	Code
6 W	5°	366 lm	80	3000K	T40010NSPW00	T40011NSPW00
		392 lm	80	4000K	T40010NSPN00	T40011NSPN00
	38°	321 lm	80	3000K	T40010WFLW00	T40011WFLW00
		344 lm	80	4000K	T40010WFLN00	T40011WFLN00
	6°x54°	366 lm	80	3000K	T40010ELPTW00	T40011ELPTW00
		392 lm	80	4000K	T40010ELPTN00	T40011ELPTN00
Electronic ballast 500mA supplied separately						
Recessing box					NL40025H0	NL40023H0
Driver	14 W	500mA	IP67	1 max	NL19046	
Driver	20 W	500mA	IP67	2 min - 2 max	NL19047	

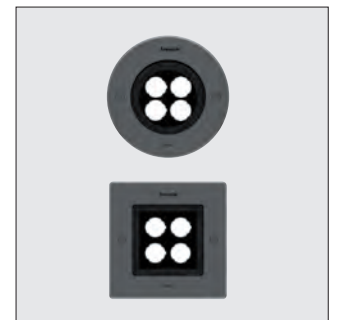

IP65/ IP67 IK09

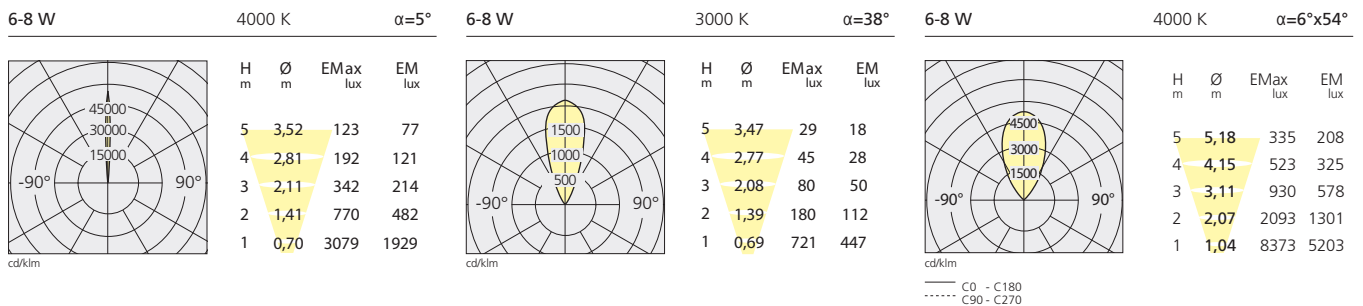
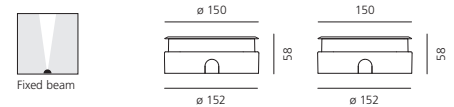

Ego 220 drive-over stainless steel

W	Beam	Flux	CRI	CCT
16 W	5°	787 lm	80	3000K
		842 lm	80	4000K
	38°	794 lm	80	3000K
		850 lm	80	4000K
	6°x54°	797 lm	80	3000K
		853 lm	80	4000K

Round
Code
T4039NSPW00
T4039NSPN00
T4039WFLW00
T4039WFLN00
T4039ELPTW00
T4039ELPTN00

Square
Code
T4009NSPW00
T4009NSPN00
T4009WFLW00
T4009WFLN00
T4009ELPTW00
T4009ELPTN00

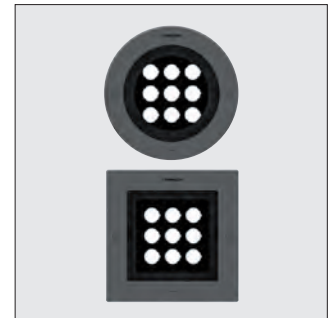

220/240Vac 50/60Hz electronic ballast included

Recessing box

T409903

T409904

IP65/ IP67 IK10

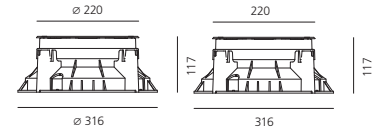
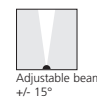

Ego 220 Flat walk-over stainless steel

W	Beam	Flux	CRI	CCT
14 W	5°	787 lm	80	3000K
		842 lm	80	4000K
	38°	794 lm	80	3000K
		850 lm	80	4000K
	6°x54°	797 lm	80	3000K
		853 lm	80	4000K

Round
Code
T40014NSPW00
T40014NSPN00
T40014WFLW00
T40014WFLN00
T40014ELPTW00
T40014ELPTN00

Square
Code
T40015NSPW00
T40015NSPN00
T40015WFLW00
T40015WFLN00
T40015ELPTW00
T40015ELPTN00

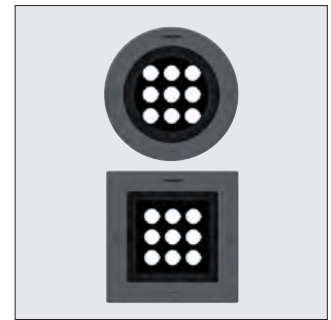

Electronic ballast 500mA supplied separately

Recessing box

NL40026H0

NL40024H0

Driver 20 W 500mA IP67 2 min - 2 max

NL19047

IP65/ IP67 IK10

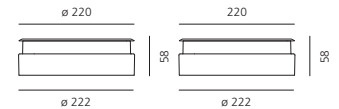

14-16 W

4000 K

$\alpha=5^\circ$

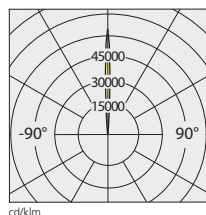

H m	Ø m	EMax lux	EM lux
5	0,42	2211	1400
4	0,34	3455	2188
3	0,25	6141	3890
2	0,17	13818	8752
1	0,08	55272	35006

14-16 W

3000 K

$\alpha=38^\circ$

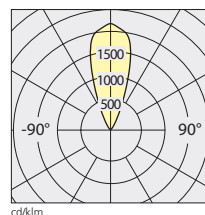

H m	Ø m	EMax lux	EM lux
5	3,44	73	46
4	2,75	114	71
3	2,06	202	126
2	1,38	454	284
1	0,69	1818	1138

14-16 W

4000 K

$\alpha=6 \times 54^\circ$

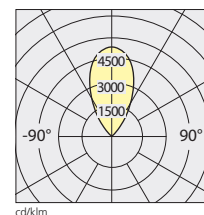

H m	Ø m	EMax lux	EM lux
5	5,18	174	108
4	4,15	272	169
3	3,11	484	301
2	2,07	1088	676
1	1,04	4352	2705

— C0 - C180
- - - C90 - C270

Ego 320 drive-over stainless steel

					Round	Square
W	Beam	Flux	CRI	CCT	Code	Code
27 W	5°	1550 lm	80	3000K	T4048NSPW00	T4018NSPW00
		1659 lm	80	4000K	T4048NSPN00	T4018NSPN00
	38°	1530 lm	80	3000K	T4048WFLW00	T4018WFLW00
		1637 lm	80	4000K	T4048WFLN00	T4018WFLN00
	6°x54°	1534 lm	80	3000K	T4048ELPTW00	T4018ELPTW00
		1641 lm	80	4000K	T4048ELPTN00	T4018ELPTN00

220/240Vac 50/60Hz electronic ballast included

Recessing box	T409901	T409902
---------------	---------	---------



IP65/ IP67 IK10

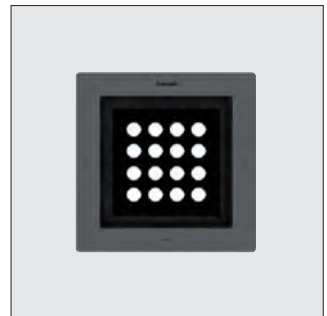
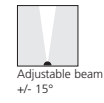
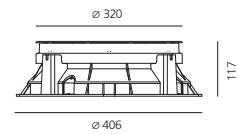

IP65/ IP67 IK10

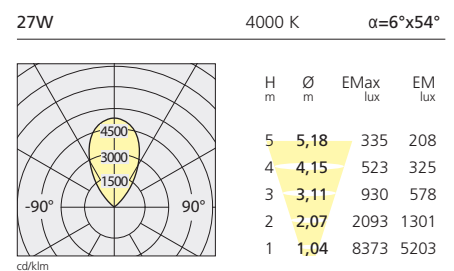
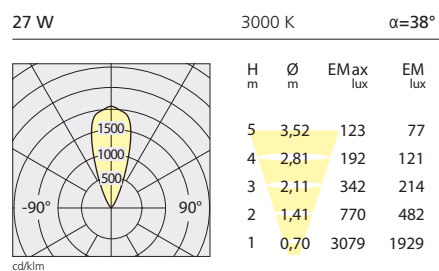
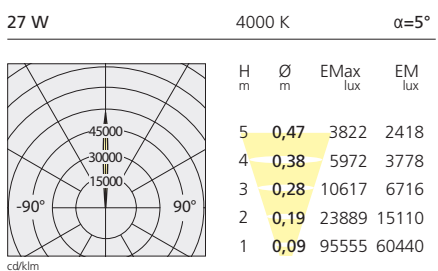
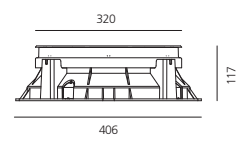

..... C0 - C180
 C90 - C270

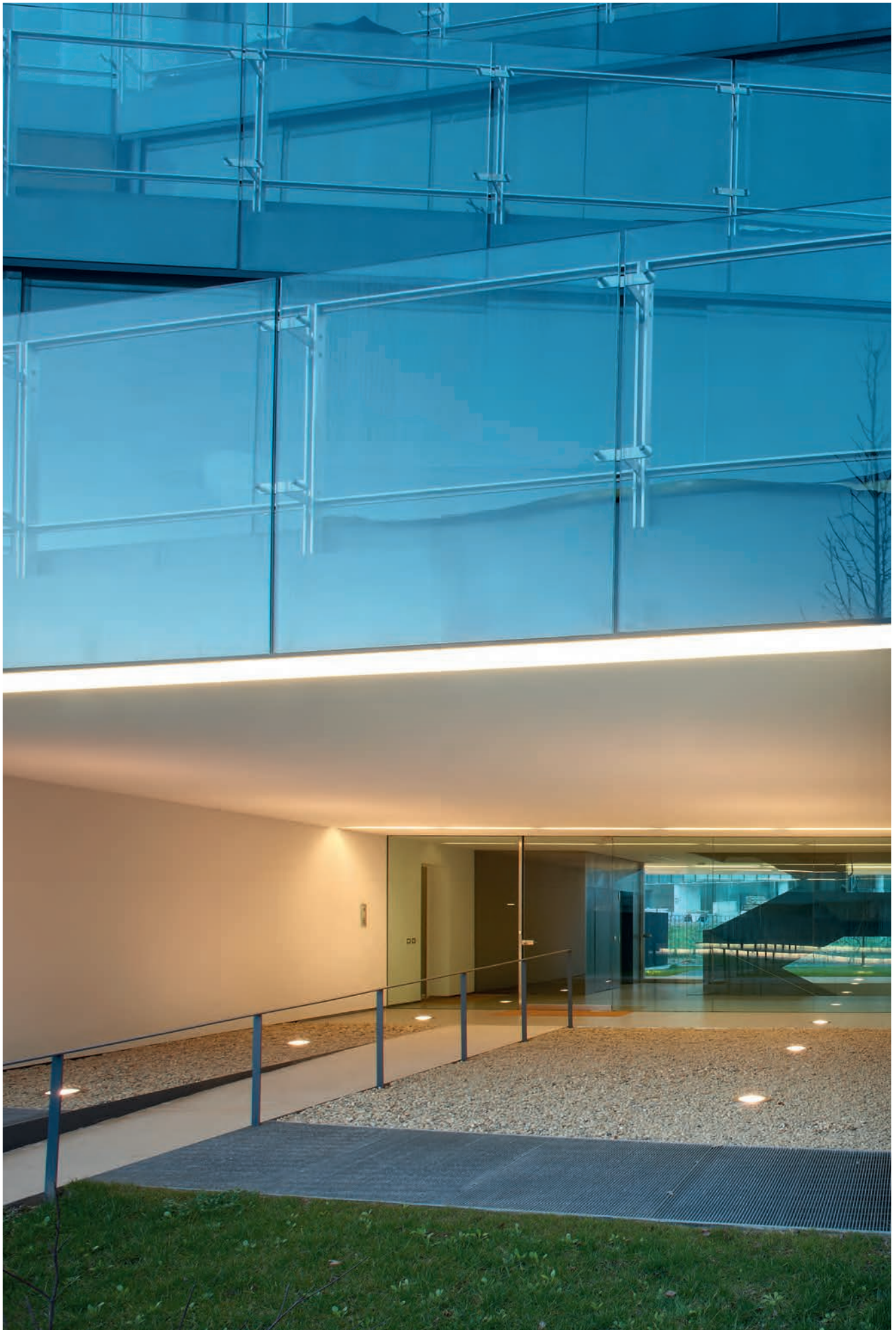

Ego 150 glass walk-over

W	Beam	Flux	CRI	CCT
8 W	5°	366 lm	80	3000K
		392 lm	80	4000K
	38°	321 lm	80	3000K
		344 lm	80	4000K
	6°x54°	366 lm	80	3000K
		392 lm	80	4000K

220/240Vac 50/60Hz electronic ballast included

Recessing box

Round
Code
T4110NSPW00
T4110NSPN00
T4110WFLW00
T4110WFLN00
T4110ELPTW00
T4110ELPTN00

T409913

Square
Code
T4100NSPW00
T4100NSPN00
T4100WFLW00
T4100WFLN00
T4100ELPTW00
T4100ELPTN00

T409914

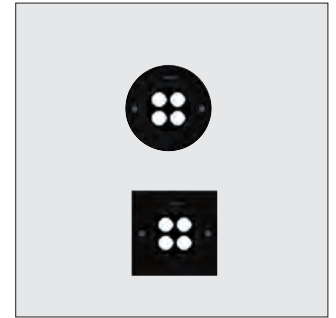

IP65/ IP67 IK09

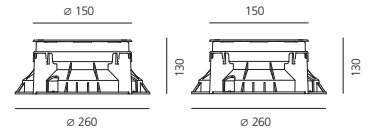

Ego 150 Flat glass walk-over

W	Beam	Flux	CRI	CCT
6 W	5°	366 lm	80	3000K
		392 lm	80	4000K
	38°	321 lm	80	3000K
		344 lm	80	4000K
	6°x54°	366 lm	80	3000K
		392 lm	80	4000K

Electronic ballast 500mA supplied separately

Recessing box

Driver	14 W	500mA	IP67	1 max
Driver	20 W	500mA	IP67	2 min - 2 max

Round
Code
T40017NSPW00
T40017NSPN00
T40017WFLW00
T40017WFLN00
T40017ELPTW00
T40017ELPTN00

NL40029H0

NL19046

NL19047

Square
Code
T40018NSPW00
T40018NSPN00
T40018WFLW00
T40018WFLN00
T40018ELPTW00
T40018ELPTN00

NL40027H0

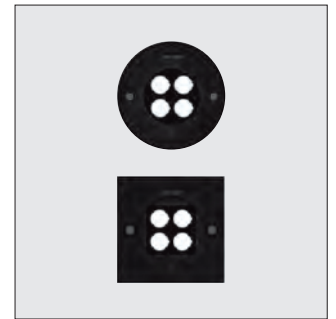

IP65/ IP67 IK09

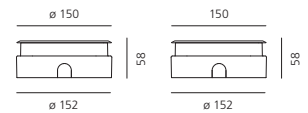

6-8 W 4000 K $\alpha=5^\circ$

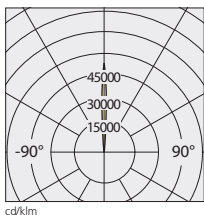

H m	Ø m	EMax lux	EM lux
5	3,52	123	77
4	2,81	192	121
3	2,11	342	214
2	1,41	770	482
1	0,70	3079	1929

6-8 W 3000 K $\alpha=38^\circ$

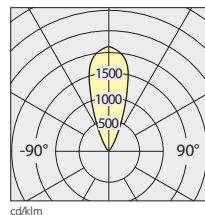

H m	Ø m	EMax lux	EM lux
5	3,47	29	18
4	2,77	45	28
3	2,08	80	50
2	1,39	180	112
1	0,69	721	447

6-8 W 4000 K $\alpha=6^\circ \times 54^\circ$

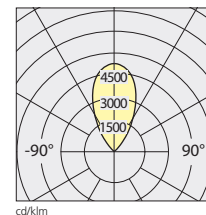

H m	Ø m	EMax lux	EM lux
5	5,18	335	208
4	4,15	523	325
3	3,11	930	578
2	2,07	2093	1301
1	1,04	8373	5203

— C0 - C180
..... C90 - C270

Ego 220 glass walk-over

					Round	Square
W	Beam	Flux	CRI	CCT	Code	Code
16 W	5°	787 lm	80	3000K	T4111NSPW00	T4101NSPW00
		842 lm	80	4000K	T4111NSPN00	T4101NSPN00
	38°	794 lm	80	3000K	T4111WFLW00	T4101WFLW00
		850 lm	80	4000K	T4111WFLN00	T4101WFLN00
	6°x54°	797 lm	80	3000K	T4111ELPTW00	T4101ELPTW00
		853 lm	80	4000K	T4111ELPTN00	T4101ELPTN00

220/240Vac 50/60Hz electronic ballast included

Recessing box

T409911

T409912

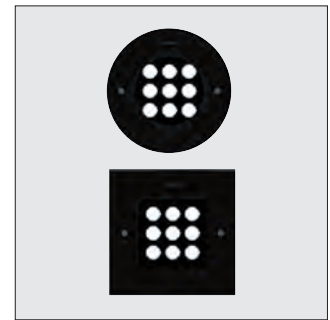

IP65/ IP67 IK09

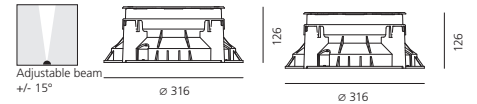

Ego 220 Flat glass walk-over

					Round	Square
W	Beam	Flux	CRI	CCT	Code	Code
14 W	5°	787 lm	80	3000K	T40019NSPW00	T40020NSPW00
		842 lm	80	4000K	T40019NSPN00	T40020NSPN00
	38°	794 lm	80	3000K	T40019WFLW00	T40020WFLW00
		850 lm	80	4000K	T40019WFLN00	T40020WFLN00
	6°x54°	797 lm	80	3000K	T40019ELPTW00	T40020ELPTW00
		853 lm	80	4000K	T40019ELPTN00	T40020ELPTN00

Electronic ballast 500mA supplied separately

Recessing box

NL40030H0

NL40028H0

Driver 20 W 500mA IP67 2 min - 2 max

NL19047

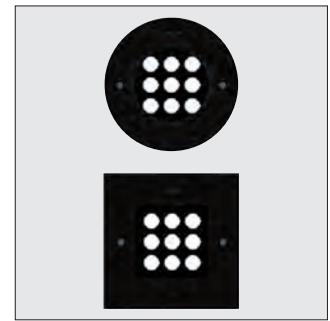

IP65/ IP67 IK09

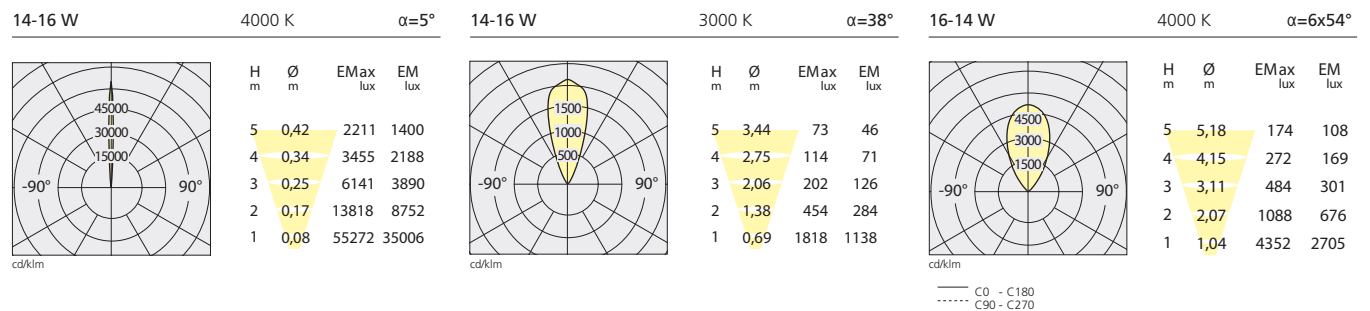
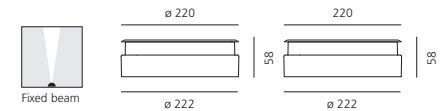

Ego 320 glass walk-over

					Round	Square
W	Beam	Flux	CRI	CCT	Code	Code
27 W	5°	1550 lm	80	3000K	T4114NSPW00	T4104NSPW00
		1659 lm	80	4000K	T4114NSPN00	T4104NSPN00
	38°	1530 lm	80	3000K	T4114WFLW00	T4104WFLW00
		1637 lm	80	4000K	T4114WFLN00	T4104WFLN00
	6°x54°	1534 lm	80	3000K	T4114ELPTW00	T4104ELPTW00
		1641 lm	80	4000K	T4114ELPTN00	T4104ELPTN00
220/240Vac 50/60Hz electronic ballast included						
Recessing box					T409909	T409910

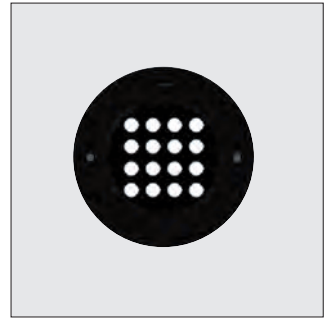

IP65/ IP67 IK10

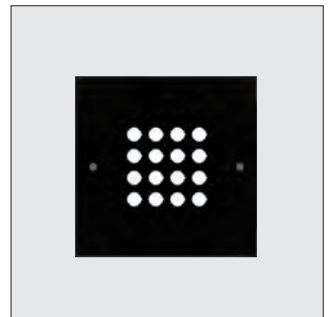
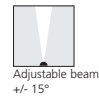
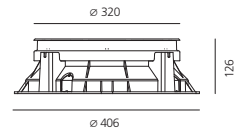

IP65/ IP67 IK10

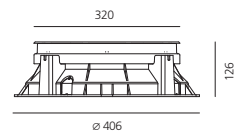

27 W 4000 K α=5°

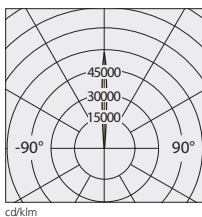

H m	Ø m	EMax lux	EM lux
5	0,47	3822	2418
4	0,38	5972	3778
3	0,28	10617	6716
2	0,19	23889	1510
1	0,09	95555	60440

27 W 3000 K α=38°

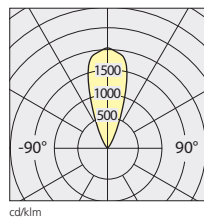

H m	Ø m	EMax lux	EM lux
5	3,52	132	83
4	2,81	206	129
3	2,11	366	229
2	1,41	823	516
1	0,70	3294	2064

27W 4000 K α=6°x54°

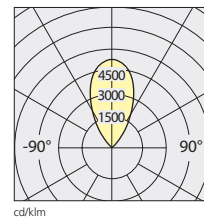

H m	Ø m	EMax lux	EM lux
5	5,18	335	208
4	4,15	523	325
3	3,11	930	578
2	2,07	2093	1301
1	1,04	8373	5203

— C0 - C180
..... C90 - C270

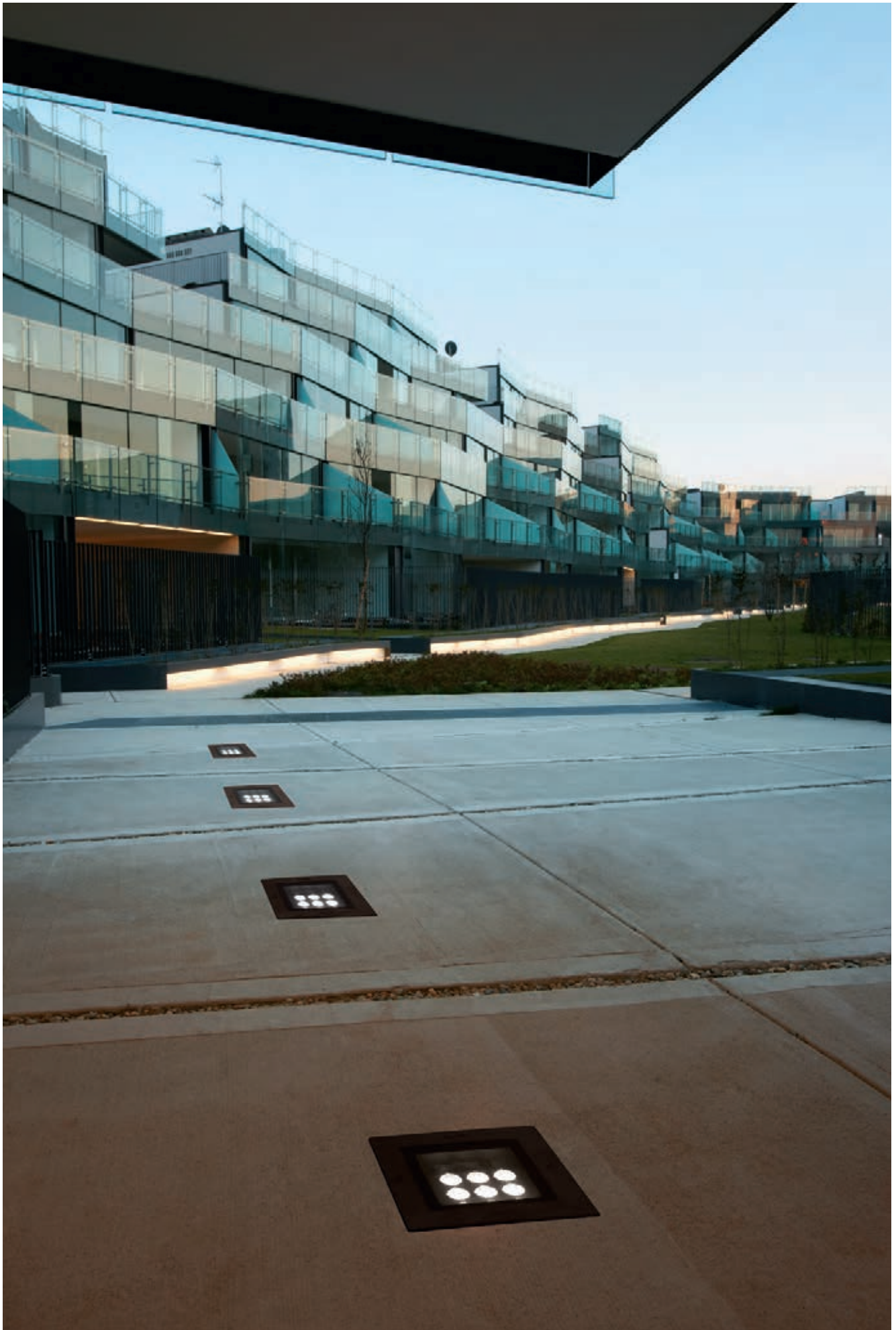

Megara

Michele De Lucchi
2011



- Light fixture with high-performance LED light sources.
- Drive-over recessed floor installation with floor-protruding cap. All the versions are drive-over up to 5000Kg. Due to the low height of the cap, Megara 90 is also suitable for installation in walk-over areas, being careful to avoid areas of direct transit (near walls, buildings, etc.).
- 3 sizes (90, 150, 220 mm).
- Composed by body, cap, diffuser, recessing box.
- Body and cap in painted EN AB44100 aluminium, silicone gaskets; provided with 30 cm-long pre-resined three-pole connection cable (H07RN-F for versions 90 and 150, H05RN-F for version 220).
- Electronic ballast integrated in the body.
- Diffuser in UV resistant polycarbonate.
- Power connection to the mains by means of the IP67 connector supplied with the light fixture, which can be housed in the recessing box and is suitable for cables with a diameter from 5 to 13.3 mm.
- Fixing to the recessing box is ensured by means of anti-vandal screws TORX.
- Recessing box for laying in reinforced polymer to be ordered separately.
- Radial emission beam optic.
- 1, 2, 4 beam and full configurations.
- White monochromatic LEDs available in 2 colour temperatures:
Warm = 3000K
Neutral = 4000K
- Screws in AISI 316 stainless steel.
- Painted die-cast aluminium with 3-stage outdoor treatment: nanotechnologies, antioxidant primer, polyester paint.
- Technical features of light fixtures in compliance with EN60598-1 and part 2-13.
- IP Rating IP65-IP67.
- ENEC approved.
- Insulation class I.
- Installation must be carried out by specialized personnel. Carefully follow the instructions.





Megara 90 - 1 beam



Megara 150 - 1 beam

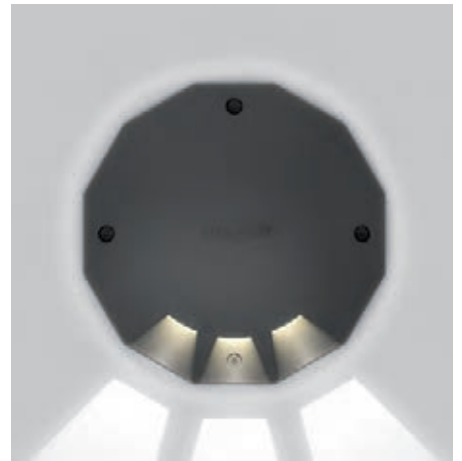

Megara 220 - 1 beam



Megara 90 - 2 beams



Megara 150 - 2 beams

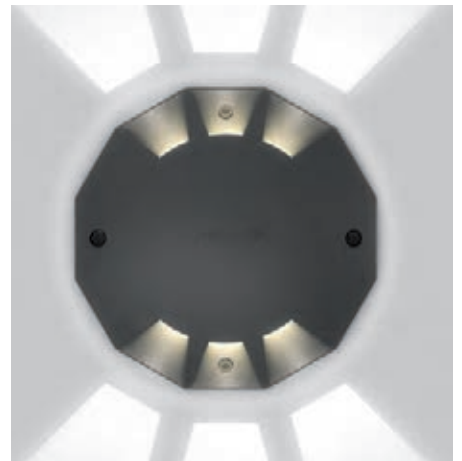

Megara 220 - 2 beams



Megara 90 - 4 beams



Megara 150 - 4 beams



Megara 220 - 4 beams



Megara 90 - full



Megara 150 - full



Megara 220 - full

Painted aluminium cap



Diffuser in UV resistant polycarbonate



Recessing box in polymer

Recessed depth:

Megara 90	101mm
Megara 150	122mm
Megara 220	118mm



Megara 90

1 Beam

W	CRI	Flux	CCT
3 W	80	6 lm	3000 K
		7 lm	4000 K

Code
T415300W00
T415300N00

220/240Vac 50/60Hz electronic ballast included

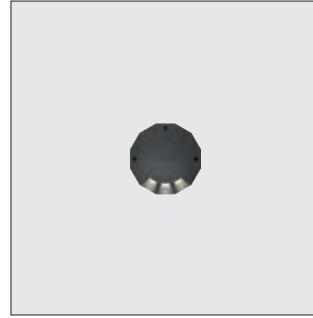

IP65/IP67 IK10

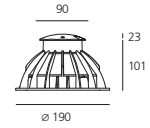

2 Beams

W	CRI	Flux	CCT
3 W	80	12 lm	3000 K
		13 lm	4000 K

Code
T415200W00
T415200N00

220/240Vac 50/60Hz electronic ballast included

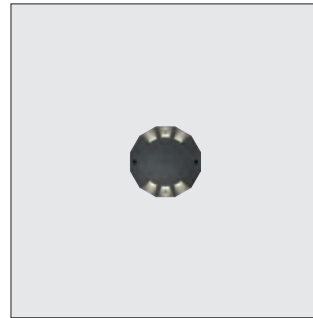

IP65/IP67 IK10

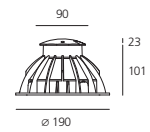

3 Beams

W	CRI	Flux	CCT
3 W	80	15 lm	3000 K
		16 lm	4000 K

Code
T415100W00
T415100N00

220/240Vac 50/60Hz electronic ballast included

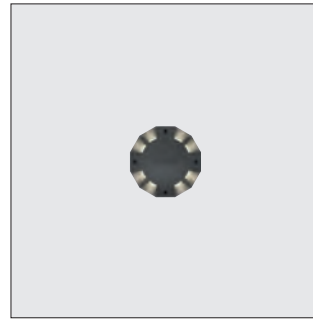

IP65/IP67 IK10

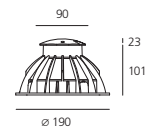

4 Beams

W	CRI	Flux	CCT
3 W	80	22 lm	3000 K
		23 lm	4000 K

Code
T415000W00
T415000N00

220/240Vac 50/60Hz electronic ballast included

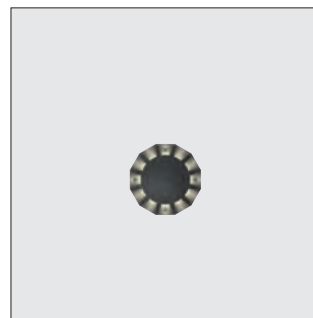

IP65/IP67 IK10

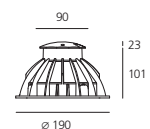

Recessing box

Code
T409907

Megara 150

1 Beam

W	CRI	Flux	CCT
4 W	80	7 lm	3000 K
		8 lm	4000 K

Code
T415700W00
T415700N00

220/240Vac 50/60Hz electronic ballast included



IP65/IP67 IK10

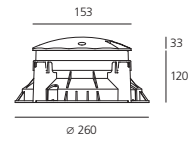

2 Beams

W	CRI	Flux	CCT
4 W	80	14 lm	3000 K
		15 lm	4000 K

Code
T415600W00
T415600N00

220/240Vac 50/60Hz electronic ballast included

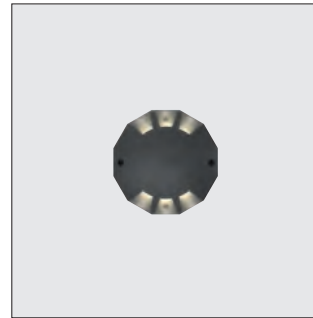

IP65/IP67 IK10

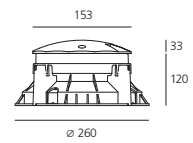

3 Beams

W	CRI	Flux	CCT
4 W	80	18 lm	3000 K
		19 lm	4000 K

Code
T415500W00
T415500N00

220/240Vac 50/60Hz electronic ballast included

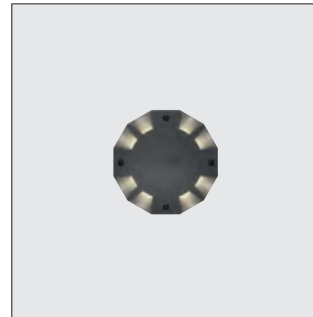

IP65/IP67 IK10

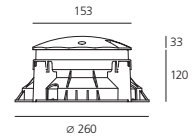

4 Beams

W	CRI	Flux	CCT
4 W	80	26 lm	3000 K
		28 lm	4000 K

Code
T415400W00
T415400N00

220/240Vac 50/60Hz electronic ballast included

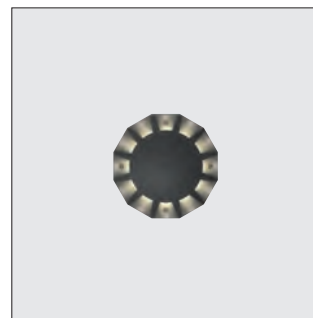

IP65/IP67 IK10

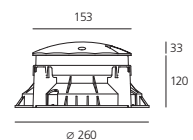

Recessing box

Code
T409905

Megara 220

1 Beam

W	CRI	Flux	CCT
9 W	80	8 lm	3000 K
		9 lm	4000 K

Code
T416100W00
T416100N00

220/240Vac 50/60Hz electronic ballast included



IP65/IP67 IK10

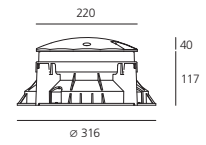

2 Beams

W	CRI	Flux	CCT
9 W	80	13 lm	3000 K
		15 lm	4000 K

Code
T416000W00
T416000N00



IP65/IP67 IK10

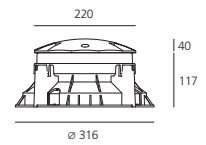

3 Beams

W	CRI	Flux	CCT
9 W	80	17 lm	3000 K
		20 lm	4000 K

Code
T415900W00
T415900N00

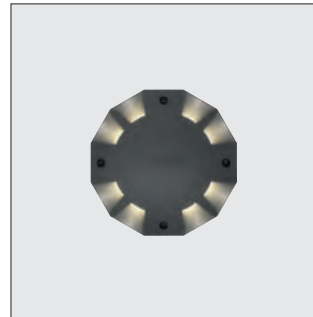

IP65/IP67 IK10

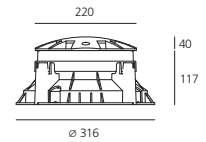

4 Beams

W	CRI	Flux	CCT
9 W	80	26 lm	3000 K
		30 lm	4000 K

Code
T415800W00
T415800N00

220/240Vac 50/60Hz electronic ballast included

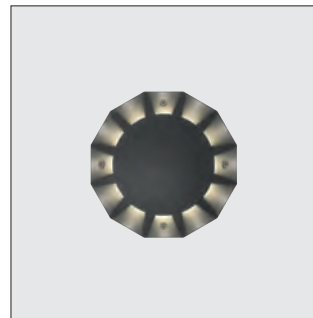

IP65/IP67 IK10

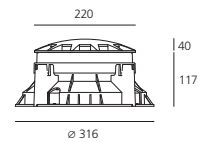

Recessing box

Code
T409903

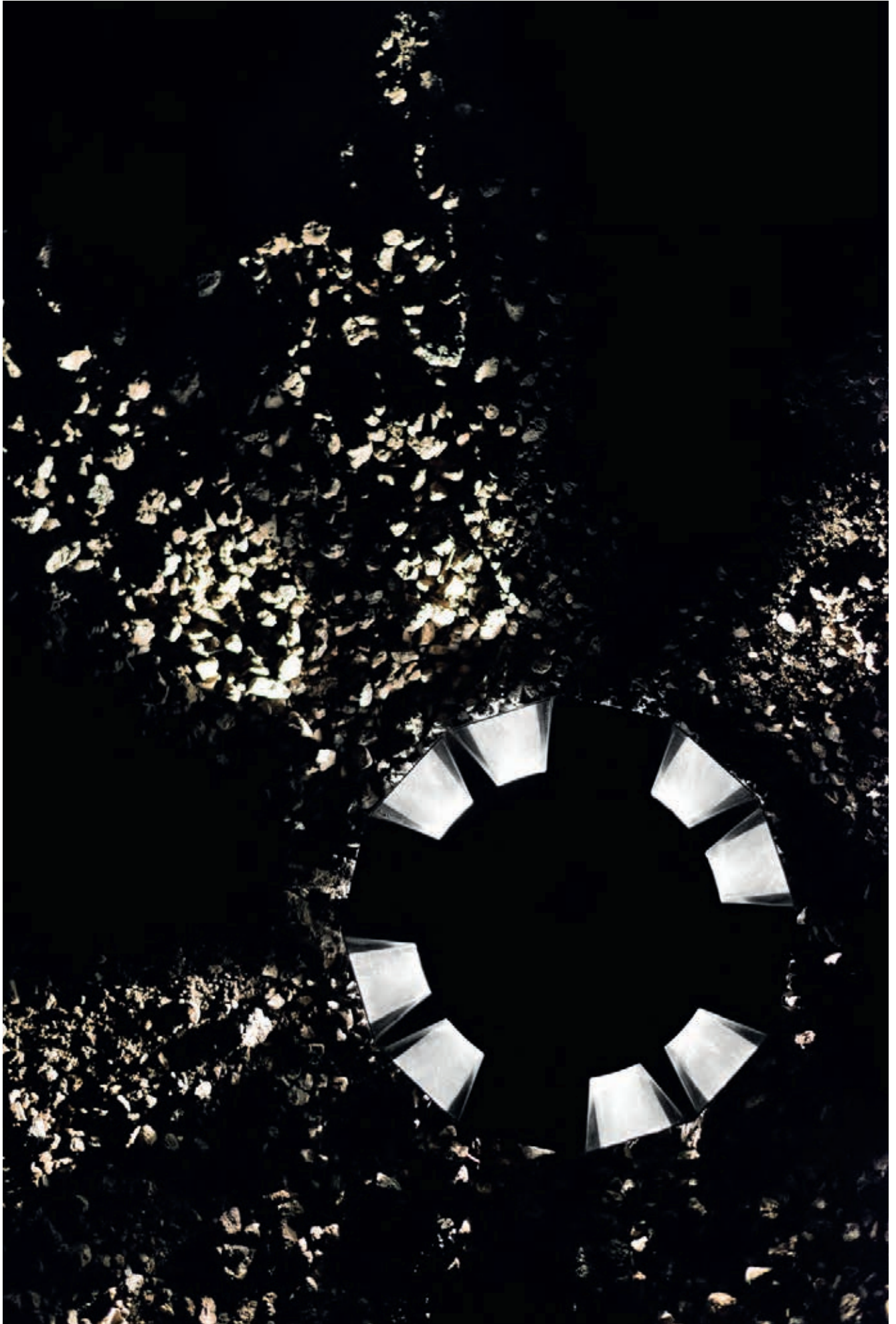

- Light fixture with LED light sources.
- Floor installation.
- Consists of diffuser, body, ring, housing.
- Diffuser in glass, 3mm-thick.
- Body in technopolymer, with or without frame.
- Ring in stainless steel AISI 316L.
- Housing in plastic material (available separately).
- Remote driver.
- Electrical connection to the ballast by means of a two-pole H05RN-F cable and appropriate IP68 terminal board.
- White monochromatic LEDs available in 2 colour temperatures:
Warm = 3000K
Neutral = 4000K
- IP65/IP67 protection rating.
- Insulation class III.
- Technical features of light fixtures in compliance with EN60598-1.
- Installation must be carried out by specialized personnel.
- Carefully follow the instructions.





Microled

W	Weight	Beam	Flux	CCT
0,5 W	0,20 kg	140°	6,9 lm	3000K
				4000K

Code
NL42036VSK0
NL42036VSW0

Driver 12Vdc SELV supplied separately

Driver	V(ac)	L _{mm}	W _{mm}	H _{mm}	IP	CCT
cc 12W 12Vdc	220-240	145	65	55	67	10max
cc 40W 12Vdc	220-240	145	65	55	67	32max

Recessing box

Code
NL19027
NL6203
NL42040H0



IP65/IP67

$\varnothing 36$

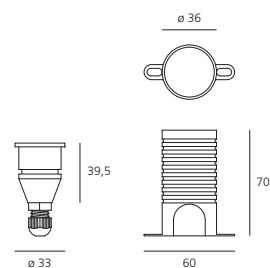

W	Weight	Beam	Flux	CCT
0,5 W	0,20 kg	140°	6,9	3000K
				4000K

Code
NL42037VSK0
NL42037VSW0

Driver 12Vdc SELV supplied separately

Driver	V(ac)	L _{mm}	W _{mm}	H _{mm}	IP	CCT
cc 12W 12Vdc	220-240	145	65	55	67	10max
cc 40W 12Vdc	220-240	145	65	55	67	32max

Recessing box

Code
NL19027
NL6203
NL42040H0

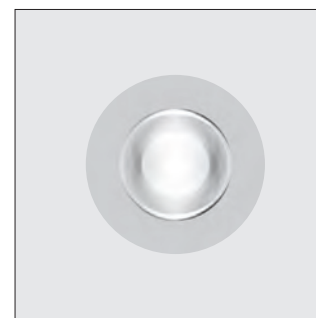

IP65/IP67

$\varnothing 36$

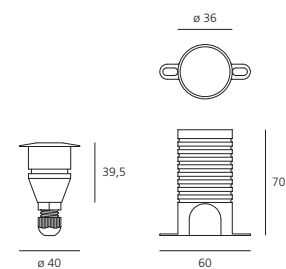

Microled RGB

W	Weight	Beam
0,5 W	0,20 kg	140°

Code
NL42038

Driver 24Vdc SELV supplied separately

Driver NLX 2-70	70 W	24Vdc	PWM	IP65	100 max
Driver NLX 2-100	100 W	24Vdc	PWM	IP65	150 max
DSC 30 USB interface DMX stand alone					
9V/350mA ballast with mini USB connector for DSC30					
50cm cable with HE10 connector for keyboard (optional)					
Recessing box					

NL81260
NL84100
NL19030
NL19031
NL7833
NL42040H0

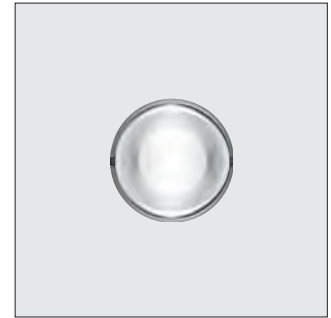

IP67

36

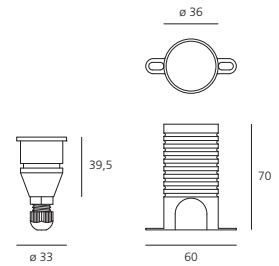

W	Weight	Beam
0,5 W	0,20 kg	140°

Code
NL42039

Driver 24Vdc SELV supplied separately

Driver NLX 2-70	70 W	24Vdc	PWM	IP65	100 max
Driver NLX 2-100	100 W	24Vdc	PWM	IP65	150 max
DSC 30 USB interface DMX stand alone					
9V/350mA ballast with mini USB connector for DSC30					
50cm cable with HE10 connector for keyboard (optional)					
Recessing box					

NL81260
NL84100
NL19030
NL19031
NL7833
NL42040H0

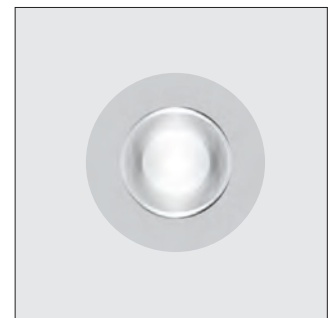

IP67

36

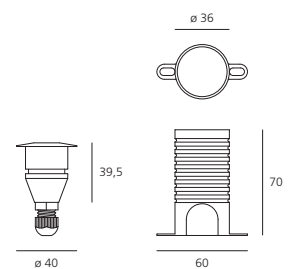



- Light fixture with high-performance LED light sources.
- Wall or ceiling installation.
- Composed by: frame, body, asymmetrical reflector, fixing springs or housing.
- Body in injection mould of aluminium.
- Frame in aluminium.
- Body and frame are painted with outdoor treatment three stages: nanotechnologies, antioxidant primer, polyester paint.
- Metalized polycarbonate reflector.
- Silicone gasket.
- Protection screen in tempered glass, 3mm-thick.
- Housing in bend metal.
- Electrical connection to the ballast by means of a cable with appropriate terminal board supplied with the fixture.
- White monochromatic LEDs available in 2 colour temperatures:
Warm = 3000K
Neutral = 4000K
- IP Rating IP65 or IP40.
- Insulation class III.
- Technical features of light fixtures in compliance with EN60598-1.
- Installation must be carried out by specialized personnel.
- Carefully follow the instructions.



Aria

White ○ Black ● Silver ●

Aria Mini

W LED	Weight	Flux	CCT	Color
3 W	0,60 kg	102 lm	3000 K	○
			4000 K	●
		107 lm	3000 K	●
			4000 K	○
8 W		262 lm	3000 K	○
			4000 K	●
		282 lm	3000 K	●
			4000 K	○

Electronic ballast 350 mA supplied separately

Electronic ballast 700 mA supplied separately

IP65

Code
NL31013VTK006
NL31013VTK004
NL31013VTK002
NL31013VTW006
NL31013VTW004
NL31013VTW002
NL31015VTK006
NL31015VTK004
NL31015VTK002
NL31015VTW006
NL31015VTW004
NL31015VTW002

IP40

Code
NL31016VTK006
NL31016VTK004
NL31016VTK002
NL31016VTW006
NL31016VTW004
NL31016VTW002
NL31017VTK006
NL31017VTK004
NL31017VTK002
NL31017VTW006
NL31017VTW004
NL31017VTW002



IP65/ IP40 72 x 52 ±2

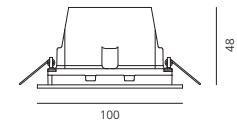

Aria Micro

W LED	Flux	CCT	Color
2,5 W	57 lm	3000 K	○
		4000 K	●
		3000 K	●
		4000 K	○

IP65

Code
NL31019VTK006
NL31019VTK004
NL31019VTK002
NL31019VTW006
NL31019VTW004
NL31019VTW002

IP40

Code
NL31018VTK006
NL31018VTK004
NL31018VTK002
NL31018VTW006
NL31018VTW004
NL31018VTW002



IP65/ IP40 49 x 46 ±2

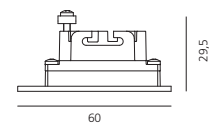

Driver	V(ac)	L _{mm}	W _{mm}	H _{mm}	IP	3 W	8 W	2,5 W	Code
cc 6W 350mA	220-240	140	65	50	67	1 max			NL11022
cc 11W 700mA	220-240	140	65	50	67		1max	2 - 4max	NL19024
cc 35W 700mA	220-240	210	70	50	67		3max	7-14max	NL19029
cc 9W 350mA	220-240	75	38	22		2max			NL19032
cc 10W 700mA	220-240	75	38	22			1max	2 - 3max	NL19035
cc 20W 700mA	220-240	125	38	23			2max	2-7max	NL19036
Recessing box	Aria Mini Aria Micro								NL31014H0 NL31020H0

Aria Mini	LED		luminaire		3 W	
Power	3 W	3 W	3 W	3 W	3 W	3 W
Flux	290 lm	305 lm	102 lm	107 lm	102 lm	107 lm
CCT	3000 K	4000 K	3000 K	4000 K	3000 K	4000 K
CRI	=85 (min.)					
Color tolerance	MacAdam 3SDCM					
Service life	L70(6K) > 36000h					
Beam						
Efficiency			35%	35%		
Efficacy	93 lm/W	98 lm/W	33 lm/W	34 lm/W		

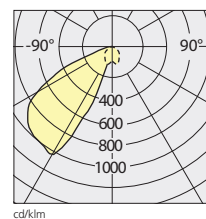

Aria Mini	LED		luminaire		8 W	
Power	8 W	8 W	8 W	8 W	8 W	8 W
Flux	810 lm	874 lm	262 lm	282 lm	262 lm	282 lm
CCT	3000 K	4000 K	3000 K	4000 K	3000 K	4000 K
CRI	=80 (min.)					
Color tolerance	MacAdam 2SDCM					
Service life	L70(6K) > 36000h					
Beam						
Efficiency			32%	32%		
Efficacy	99 lm/W	107 lm/W	32 lm/W	35 lm/W		

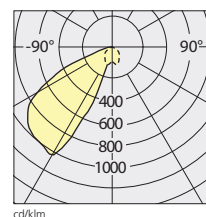

Aria Micro	LED		luminaire		2,5 W	
Power	2,5 W	2,5 W	2,5 W	2,5 W	2,5 W	2,5 W
Flux	165 lm	177 lm	57 lm	61 lm	57 lm	61 lm
CCT	3000 K	4000 K	3000 K	4000 K	3000 K	4000 K
CRI	=80 (min.)					
Color tolerance	MacAdam 4SDCM					
Service life	L70(10K) > 60500h					
Beam						
Efficiency			34%	34%		
Efficacy	72 lm/W	77 lm/W	21 lm/W	23 lm/W		

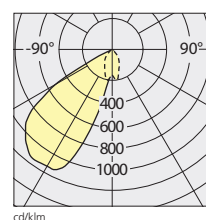

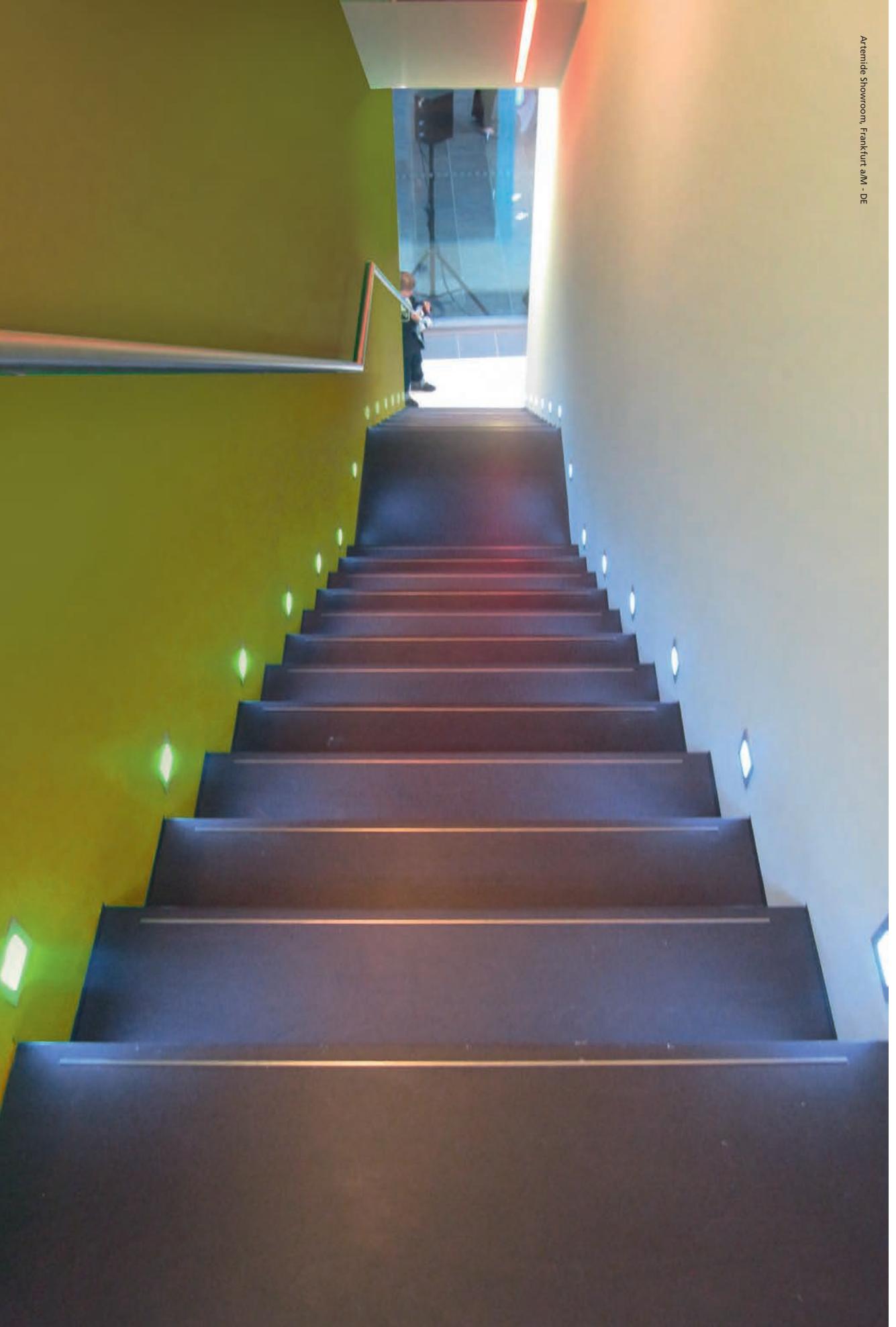

Faci

Ernesto Gismondi
2012

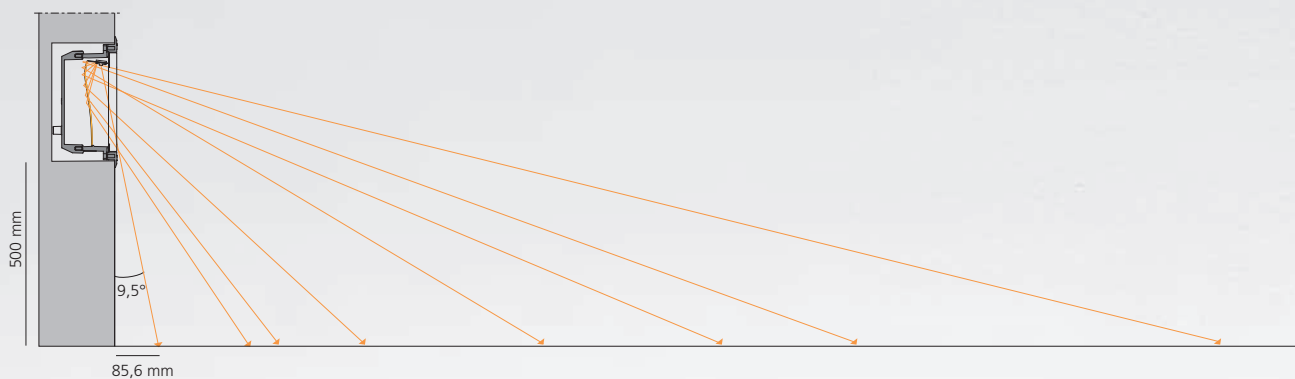
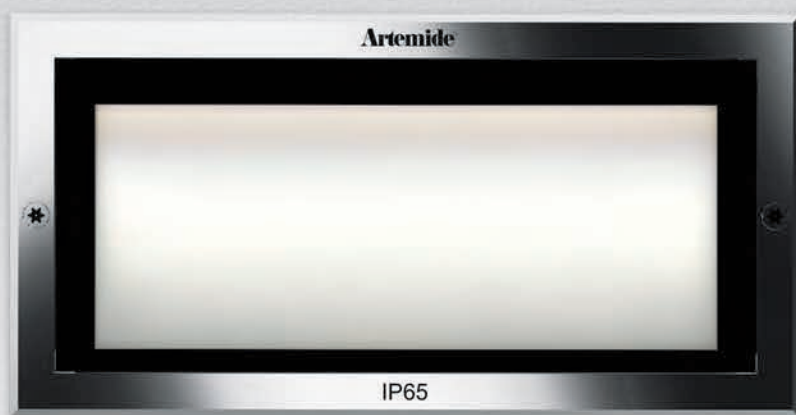

Recessed hole

Faci 12
160 x 160 x 80 mm
Faci 24
280 x 160 x 80 mm
Faci 36
400 x 160 x 80 mm

Recessing box

Faci 12
135 x 137 x 75 mm
Faci 24
256 x 137 x 75 mm
Faci 36
376 x 137 x 75 mm

Body in nylon reinforced with fibre glass

Reflector in optic aluminium with high coefficient of reflection + strip LED

Tempered glass and cromed zamak frame



- Light fixture with high-performance LED light sources.
- Recessed wall installation.
- 3 sizes (120, 240 and 360 mm length).
- Consist of by lamp body and recessing box.
- Body in high-resistance reinforced polymer. The lamp body is snap-fitted into the recessing box, then it is fixed by means of two anti-vandal screws Torx. This product is suitable for areas at risk of vandalism.
- Aluminium reflector conveying and diffusing the light flow downwards to ensure an even floor lighting and visual comfort without glare.
- Diffuser in 8mm-thick silkscreened tempered glass to ensure higher vandal-proof resistance.
- Front frame in chromed zamac.
- Recessing box for laying in reinforced polymer, with low depth, can be ordered separately.
- Wiring inside the lamp body with IP65 grommet suitable for cables with a diameter of 8-12 mm for the connection to the mains.
- AISI 316 setscrews and silicone seal gaskets.
- Technical features of light fixtures in compliance with EN60598-1.
- IP Rating IP65.
- ENEC approved.
- Insulation class II.
- Installation must be carried out by specialized personnel. Carefully follow the instructions.

Faci 12

Polished



Faci 12

W	Flux	CCT	CRI	Color	Code
3 W	62 lm	3000 K	85	☉	T417400W00
	71 lm	4000 K	80	☉	T417400N00

220/240Vac 50/60Hz electronic ballast 50/60Hz included

Recessing box 135x137x75 mm

T409921

3 W 4000 K

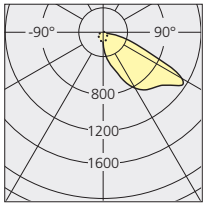

— C = 0°-180° Cd/klm
 C = 90°-270°



IP65 IK10

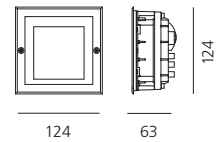

Faci 24

W	Flux	CCT	CRI	Color	Code
5 W	189 lm	3000 K	85	☉	T417600W00
	215 lm	4000 K	80	☉	T417600N00

220/240Vac 50/60Hz electronic ballast 50/60Hz included

Recessing box 256x137x75 mm

T409922

5 W 4000 K

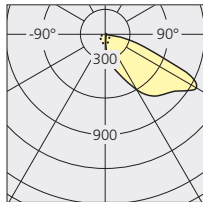

— C = 0°-180° Cd/klm
 C = 90°-270°



IP65 IK10

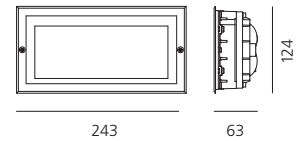

Faci 36

W	Flux	CCT	CRI	Color	Code
9 W	265 lm	3000 K	85	☉	T417800W00
	302 lm	4000 K	80	☉	T417800N00

220/240Vac 50/60Hz electronic ballast 50/60Hz included

Recessing box 376x137x75 mm

T409923

9 W 4000 K

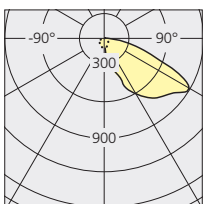

— C = 0°-180° Cd/klm
 C = 90°-270°



IP65 IK10

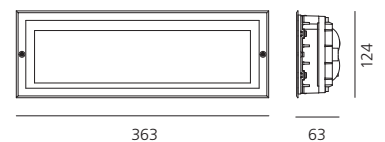



Faci vetro

Ernesto Gismondi
2012

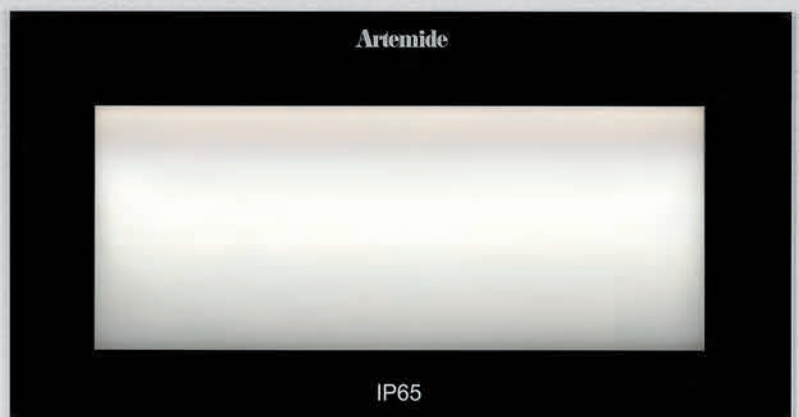
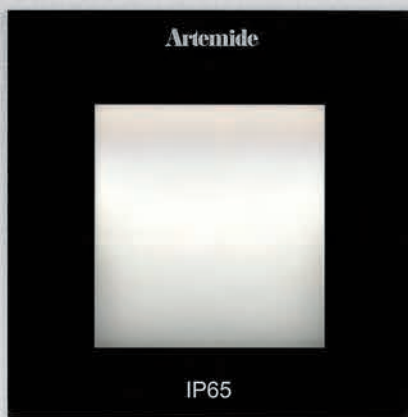

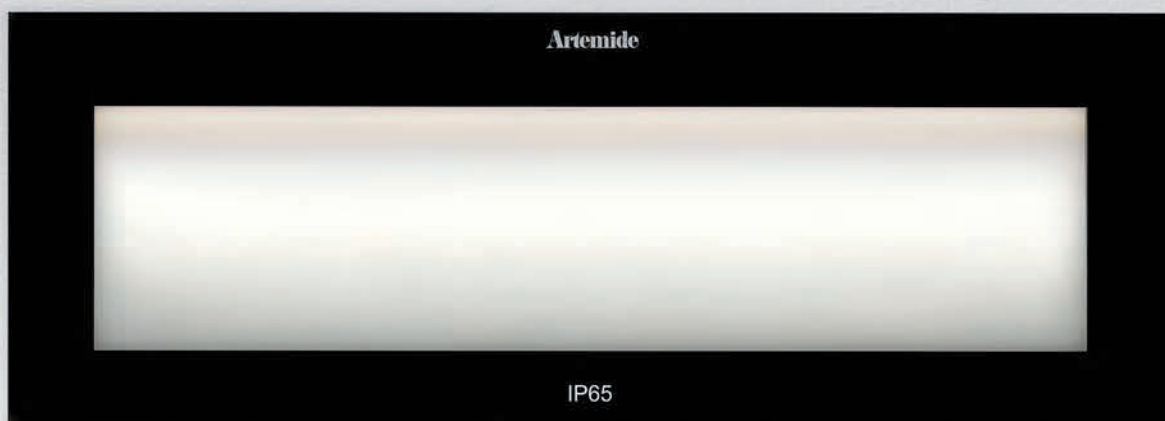

- Light fixture with high-performance LED light sources.
- Recessed wall installation.
- Consist of 3 sizes (120, 240 and 360mm length).
- Composed by lamp body and recessing box.
- Body in high-resistance reinforced polymer. The lamp body is snap-fitted into the recessing box, so the final product has no visible screws and the glass is flush with the wall.
- Aluminium reflector conveying and diffusing the light flow downwards to ensure an even floor lighting and visual comfort without glare.
- Diffuser in 6mm-thick silkscreened tempered glass.
- Recessing box for laying in reinforced polymer, with low depth, can be ordered separately.
- Wiring inside the lamp body with IP65 grommet suitable for cables with a diameter of 8-12mm for the connection to the mains.
- AISI 316 setscrews and silicone seal gaskets.
- Technical features of light fixtures in compliance with EN60598-1.
- IP Rating IP65.
- ENEC approved.
- Insulation class II.
- Installation must be carried out by specialized personnel. Carefully follow the instructions.

Faci vetro



Recessed hole

Faci 12
160 x 160 x 80 mm
Faci 24
280 x 160 x 80 mm
Faci 36
400 x 160 x 80 mm



Recessing box

Faci 12
135 x 137 x 75 mm
Faci 24
256 x 137 x 75 mm
Faci 36
376 x 137 x 75 mm



Lighting unit



Faci vetro

Faci vetro 12

W	Flux	CCT	CRI	Color	Code
3 W	62 lm	3000 K	85		T417500W00
	71 lm	4000 K	80		T417500N00

220/240Vac 50/60Hz electronic ballast 50/60Hz included

Recessing box 135x137x75 mm

T409921

3 W 4000 K

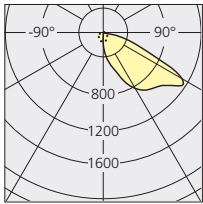

— C = 0°-180° Cd/Klm
 C = 90°-270°



IP65 IK10

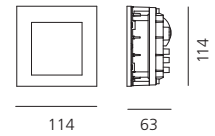

Faci vetro 24

W	Flux	CCT	CRI	Color	Code
5 W	189 lm	3000 K	85		T417700W00
	215 lm	4000 K	80		T417700N00

220/240Vac 50/60Hz electronic ballast 50/60Hz included

Recessing box 256x137x75 mm

T409922

5 W 4000 K

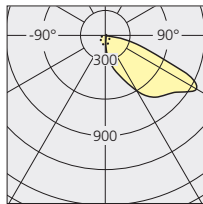

— C = 0°-180° Cd/Klm
 C = 90°-270°



IP65 IK10

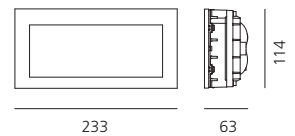

Faci vetro 36

W	Flux	CCT	CRI	Color	Code
9 W	265 lm	3000 K	85		T417900W00
	302 lm	4000 K	80		T417900N00

220/240Vac 50/60Hz electronic ballast 50/60Hz included

Recessing box 376x137x75 mm

T409923

9 W 4000 K

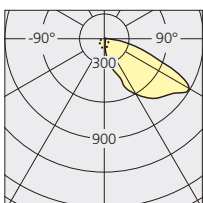

— C = 0°-180° Cd/Klm
 C = 90°-270°



IP65 IK10

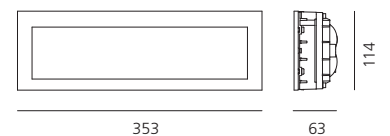







- Light fixture with high-performance LED light sources.
- Recessed wall installation.
- Consist of body in extruded aluminium, protection glass (IP65) or polycarbonate diffuser (IP40); provided with junction box for input/output connection, housing, end caps.
- Body in extruded EN AW6060 T5 aluminium.
- 4mm-thick transparent tempered glass, IP65.
- Glass surface temperature lower than 35°C.
- 1mm-thick transparent polycarbonate, IP40.
- End caps in extruded aluminium with silicone gasket.
- Concrete recessing box in extruded aluminium for laying in, with end caps and accessories for series connection (to be ordered separately).
- Recessing box for panels or plasterboard in painted metal (to be ordered separately).
- Installation of both version in panels (wood, plasterboard) or in concrete/bricks with appropriate housings.
- 24Vdc remote ballast.
- Electrical connection to the ballast by means of H05RN-F cable, with IP68 terminal block supplied with the fixture.
- Painted profile with 2-stage outdoor treatment: primer, outdoor paint.
- White monochromatic LEDs available in 2 colour temperatures:
Warm = 3000K
Neutral = 4000K
- IP Rating IP40 or IP65.
- Insulation class III.
- Technical features of light fixtures in compliance with EN60598-1.
- Installation must be carried out by specialized personnel.
- Carefully follow the instructions.

Percorso IP65

White Black

CRI = 80(min)

W	L	Weight	Flux	Efficacy	CCT	Color
2 W	256	0,60kg	108 lm	54 lm/W	3000K	●
			120 lm	60 lm/W	4000K	●
						○
						○
5 W	616	1,00kg	270 lm	54 lm/W	3000K	●
			300 lm	60 lm/W	4000K	●
						○
						○
8 W	976	1,50kg	432 lm	54 lm/W	3000K	●
			480 lm	60 lm/W	4000K	●
						○
						○

Code
NL50026VSK004
NL50026VSK006
NL50026VSW004
NL50026VSW006
NL50014VSK004
NL50014VSK006
NL50014VSW004
NL50014VSW006
NL50015VSK004
NL50015VSK006
NL50015VSW004
NL50015VSW006

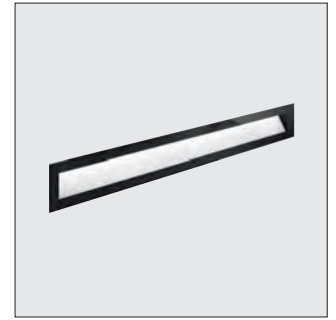

L x 130 x 70h

Driver 24Vdc SELV supplied separately
Dimmable fixture, dimming devices available upon request.

		2 W	5 W	8 W			
Driver	IP67	40 W	24Vdc	16 max	6 max	4 max	NL62040
Driver	IP67	70 W	24Vdc	30 max	12 max	7 max	NL89080
Driver	IP67	150 W	24Vdc	40 max	16 max	10 max	NL62880

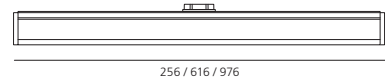

Maximum linear length of a series of products with one supply line:
6m. For lines exceeding 6m, provide multiple supply lines.

	L mm	Code
Recessing box Single / Side for module 256	268	NL50028H0
Recessing box Central for module 256	256	NL50029H0
Recessing box Single / Side for module 616	628	NL50018H0
Recessing box Central for module 616	616	NL50019H0
Recessing box Single / Side for module 976	988	NL50020H0
Recessing box Central for module 976	976	NL50021H0
End pieces (Dx Sx)	●	NL50025004
	○	NL50025006
Pair of end pieces for external recessed housing		NL50024
Power supply connector & connector end cap		NL19052
Extracting tool		NL50054

1000 mm 4000 K

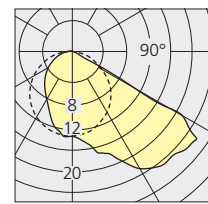

cd/klm
--- C0 - C180
- - - C90 - C270

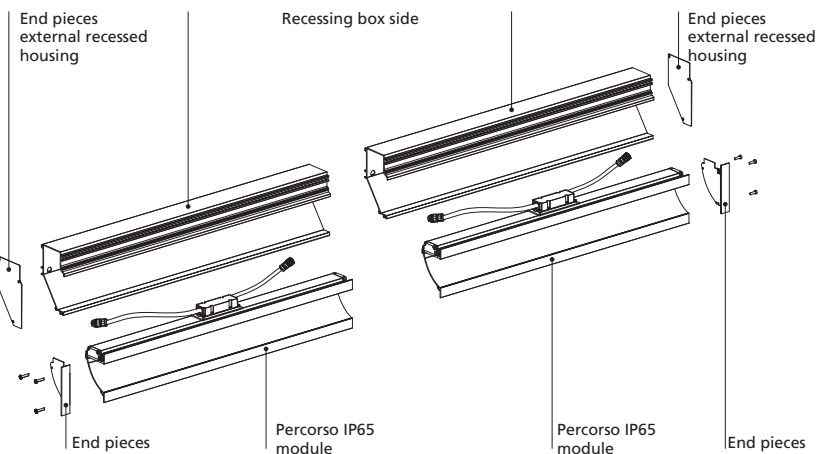
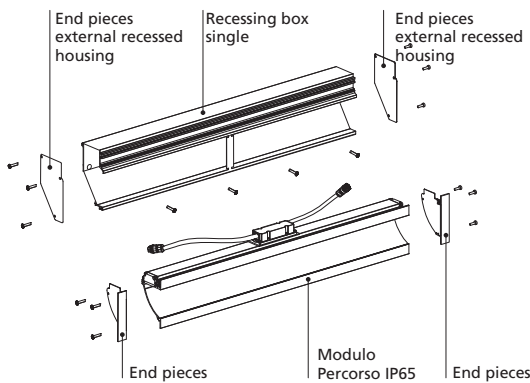

Percorso IP40

White Black

CRI = 80(min)

W	L	Weight	Flux	Efficacy	CCT	Color
2 W	250	0,60kg	108 lm	54 lm/W	3000K	●
						○
			120 lm	60 lm/W	4000K	●
						○
5 W	610	1,00kg	270 lm	54 lm/W	3000K	●
						○
			300 lm	60 lm/W	4000K	●
						○
8 W	970	1,50kg	432 lm	54 lm/W	3000K	●
						○
			480 lm	60 lm/W	4000K	●
						○

Code
NL50027VSK004
NL50027VSK006
NL50027VSW004
NL50027VSW006
NL50016VSK004
NL50016VSK006
NL50016VSW004
NL50016VSW006
NL50017VSK004
NL50017VSK006
NL50017VSW004
NL50017VSW006

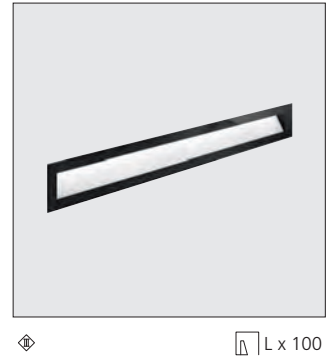

Driver 24Vdc SELV supplied separately
Dimmable fixture, dimming devices available upon request.

	2 W	5 W	8 W		
Driver	10 W	24Vdc	4 max	1 max	1 max
Driver	19 W	24Vdc	8 max	3 max	2 max
Driver	70 W	24Vdc	30 max	12 max	7 max

NL10964
NL19040
NL8711

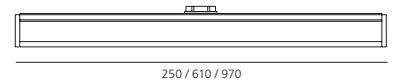

Maximum linear length of a series of products with one supply line: 6m. For lines exceeding 6m, provide multiple supply lines.

	L mm
Recessing box for panels for module 250	268
Recessing box for panels for module 610	628
Recessing box for panels for module 970	988
End pieces (Dx Sx)	●
	○
Power supply connector & connector end cap	
Extracting tool	

Code
NL50030H0
NL50022H0
NL50023H0
NL50025004
NL50025006
NL19052
NL50054

1000 mm 4000 K

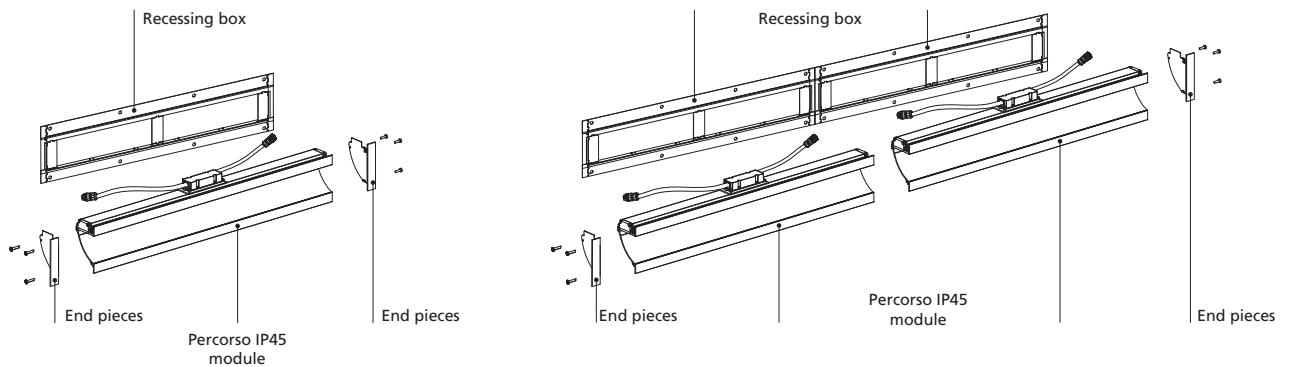
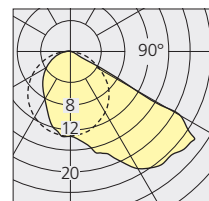



Graphic Lighting
General Lighting
Path Lighting

758	Effetto
764	Calumet
768	Molla
770	Pantarei
774	Niki
778	Dioscuri
782	Mitasi
784	Cuneo
788	Basolo
790	Illo Cantilina Aglaia
792	Nuda
798	Ciclope
804	Chilone
810	Tetragono
814	Eraclea
816	Ippolito
818	Logico Garden
822	Piroscafo
824	Granito
828	Reeds

Effetto

Ernesto Gismondi
2011

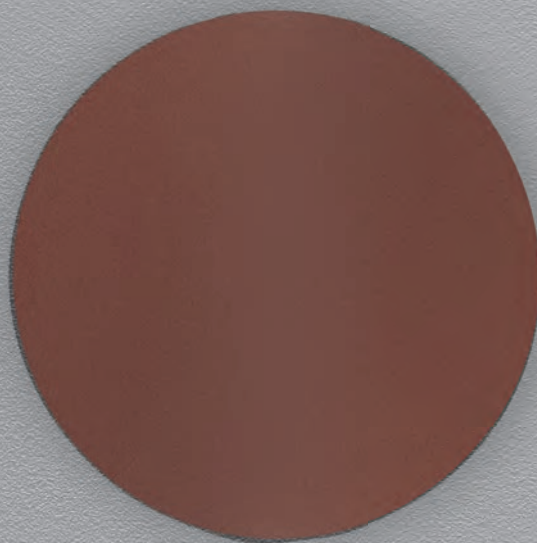
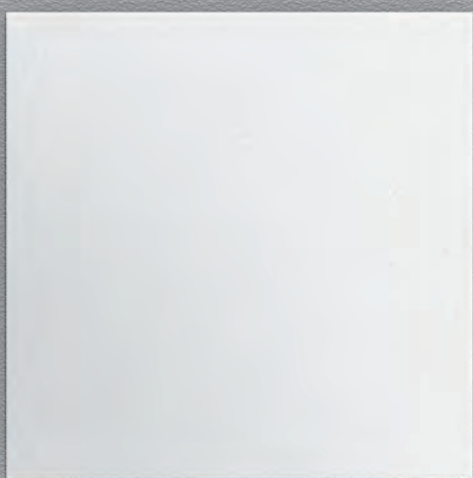

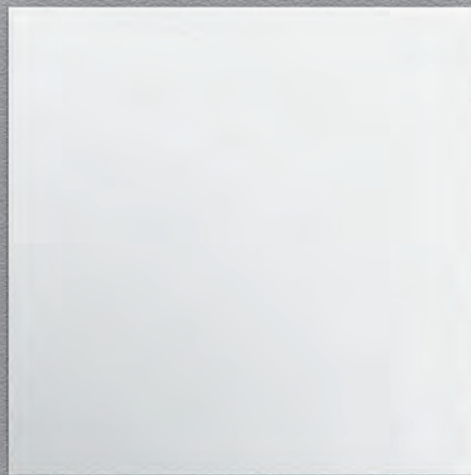

- Light fixture with 1, 2 or 4 light beams using monochromatic LED light sources together with light-diffusing lenses which optimize the optical performance of the beams and establish their width. Designed to create geometric lights of scenic effect, it is available with beams of the same spread or with combined beams.
- Beam spread 15° and 90°.
- Wall installation.
- Available in two shapes: square and round and in two finishes: grey-white painted and rust painted.
- Consists of lighting cap unit and terminal board fixed together by means of locking dowels.
- Cap in die-cast EN AB-47100 aluminium.
- Terminal board in reinforced polymer.
- Watertight gasket in silicone rubber.
- Electronic ballast integrated in the fixture.
- PMMA lenses siliconed flush with the cap to obtain two different beam angle opening (narrow and wide).
- White monochromatic LEDs available in 2 colour temperatures:
Warm = 3000K
Neutral = 4000K
- Wiring to be carried out inside the terminal board by piercing an IP65 membrane grommet suitable for cables with a diameter of 6-13 mm.
- Locking dowels used outside the fixture in AISI 316 stainless steel.
- Painted die-cast aluminium with 3-stage outdoor treatment: nanotechnologies, antioxidant primer, polyester paint.
- Technical features of light fixtures in compliance with EN60598-1.
- IP Rating IP65.
- ENEC approved.
- Insulation class II.

Effetto

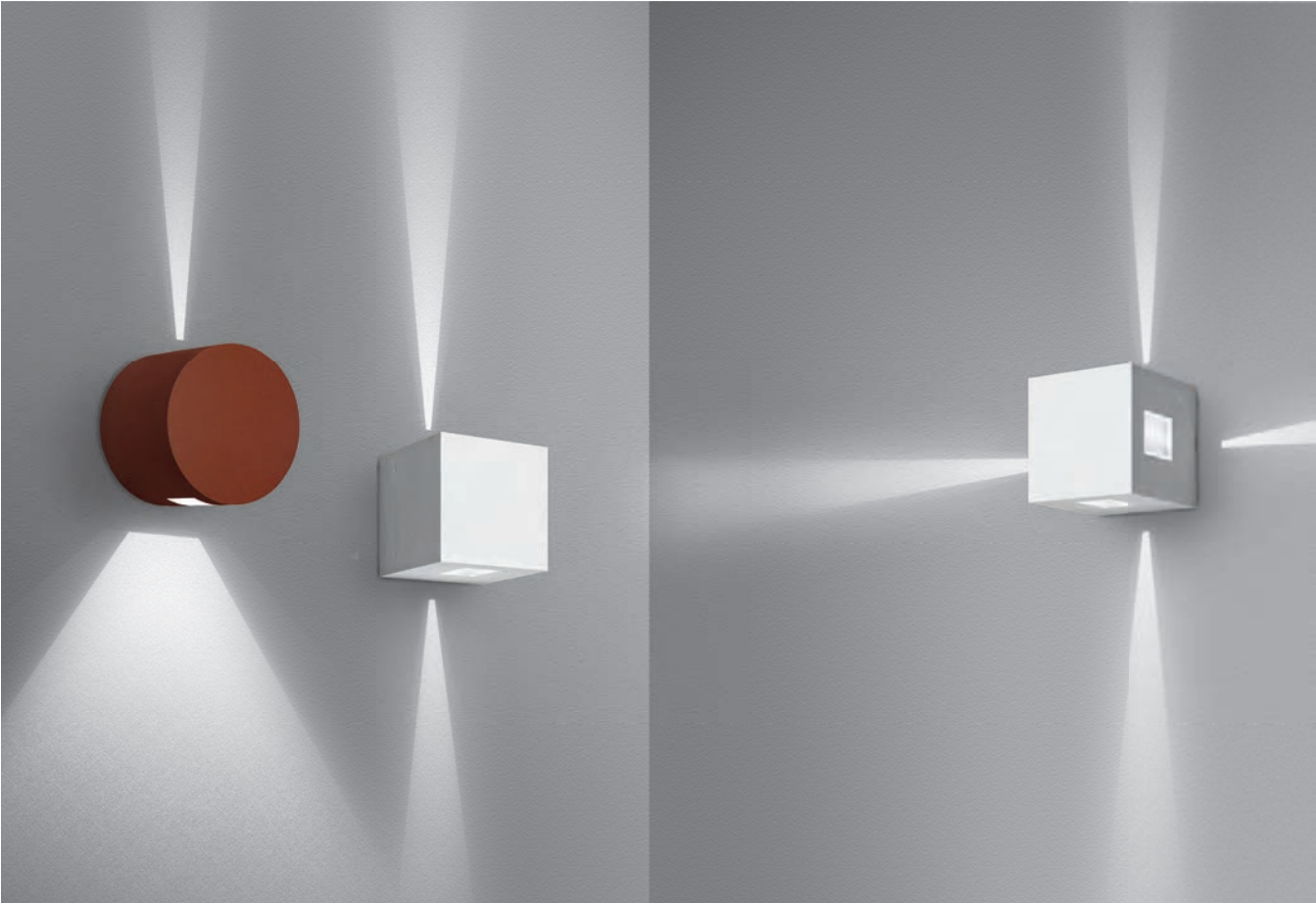
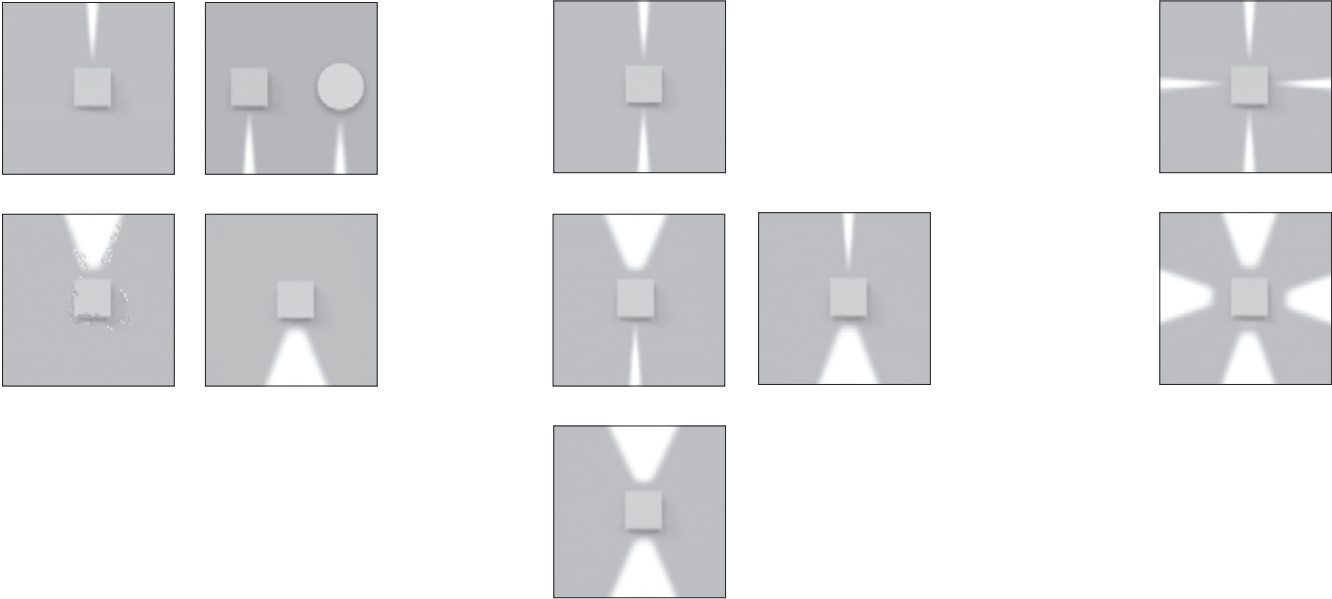





1 narrow beam

W (LED)	Beam Square	Beam Round	Flux Square	Flux Round	CCT	Color
4,5 W	1x4°	1x2°	19 lm	23,47 lm	3000 K	○
			19 lm	23,47 lm	4000 K	●

Square

Code
T42021NW00
T42021NW10
T42021NN00
T42021NN10

Round

Code
T42121NW00
T42121NW10
T42121NN00
T42121NN10

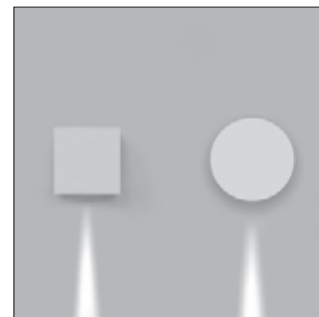

IP65 IK10

220/240Vac 50/60Hz electronic ballast included.

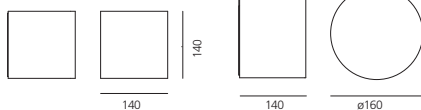

1 large beam

W (LED)	Beam Square	Beam Round	Flux Square	Flux Round	CCT	Color
4,5 W	1x46°	1x38°	54,50 lm	49,90 lm	3000 K	○
			54,50 lm	49,90 lm	4000 K	●

Square

Code
T42021LW00
T42021LW10
T42021LN00
T42021LN10

Round

Code
T42121LW00
T42121LW10
T42121LN00
T42121LN10



IP65 IK10

220/240Vac 50/60Hz electronic ballast included.

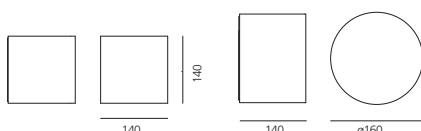

2 narrow beams

W (LED)	Beam Square	Beam Round	Flux Square	Flux Round	CCT	Color
7 W	2x4°	2x2°	37,62 lm	49,34 lm	3000 K	○
			37,62 lm	49,34 lm	4000 K	●

Square

Code
T42012NW00
T42012NW10
T42012NN00
T42012NN10

Round

Code
T42112NW00
T42112NW10
T42112NN00
T42112NN10



IP65 IK10

220/240Vac 50/60Hz electronic ballast included.

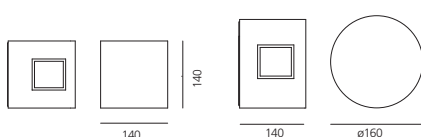

1 narrow beam 1 large beam

W (LED)	Beam Square	Beam Round	Flux Square	Flux Round	CCT	Color
7 W	1x4°+1x46°	1x2°+1x38°	73,32 lm	73,36 lm	3000 K	○
			73,32 lm	73,36 lm	4000 K	●

Square

Code
T42011NLW00
T42011NLW10
T42011NLN00
T42011NLN10

Round

Code
T42111NLW00
T42111NLW10
T42111NLN00
T42111NLN10



IP65 IK10

220/240Vac 50/60Hz electronic ballast included.

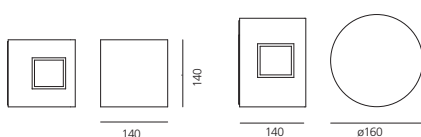

Effetto

Grey-white RAL9002 ○ Rust ●

2 large beams

W (LED)	Beam	Beam	Flux	Flux	CCT	Color
	Square	Round	Square	Round		
7 W	2x46°	2x38°	109 lm	99,82 lm	3000 K	○
			109 lm	99,82 lm	4000 K	●
					3000 K	○
					4000 K	●

Square

Code
T42012LW00
T42012LW10
T42012LN00
T42012LN10

Round

Code
T42112LW00
T42112LW10
T42112LN00
T42112LN10



IP65 IK10

220/240Vac 50/60Hz electronic ballast included.

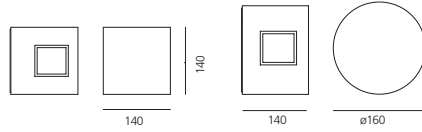

4 narrow beams

W (LED)	Beam	Beam	Flux	Flux	CCT	Color
	Square	Round	Square	Round		
11 W	4x4°	4x2°	76,10 lm	102,36 lm	3000 K	○
			76,10 lm	102,36 lm	4000 K	●
					3000 K	○
					4000 K	●

Square

Code
T42004NW00
T42004NW10
T42004NN00
T42004NN10

Round

Code
T42104NW00
T42104NW10
T42104NN00
T42104NN10

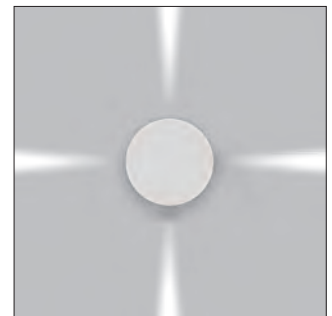

IP65 IK10

220/240Vac 50/60Hz electronic ballast included.

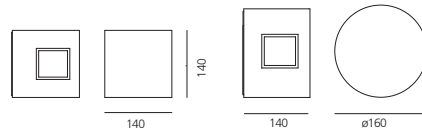

4 large beams

W (LED)	Beam	Beam	Flux	Flux	CCT	Color
	Square	Round	Square	Round		
11 W	4x46°	4x38°	218,59 lm	102,36 lm	3000 K	○
			218,59 lm	102,36 lm	4000 K	●
					3000 K	○
					4000 K	●

Square

Code
T42004LW00
T42004LW10
T42004LN00
T42004LN10

Round

Code
T42104LW00
T42104LW10
T42104LN00
T42104LN10

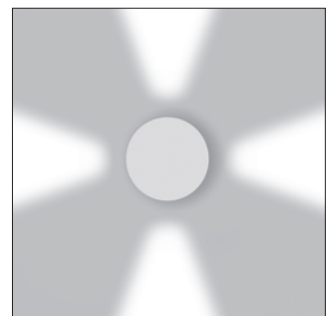

IP65 IK10

220/240Vac 50/60Hz electronic ballast included.

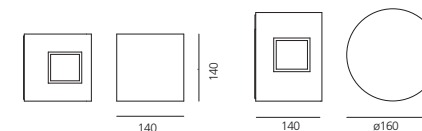



Calumet wall

- Lighting system with single or double emission, with high-performance LED light sources combined with lenses which optimize the light emitting efficiency of the beams and determine their spread.
- Available in two sizes: $\varnothing 8$ e $\varnothing 13$ cm.
- Ceiling and wall installation.
- Available in two finishes: light grey and anthracite grey painted.
- Single or double emission version.
- Consist of lighting body, lighting cap and wall fixing bracket.
- Cylindrical body in EN AW-6060 aluminium containing the electronic power supply components.
- Optical lighting body in EN AW-6060 aluminium.
- Led and collimator lenses which swing by means of an aluminium bracket.
- Diffuser in toughened glass.
- Wall fixing bracket in bent steel.
- Water tight silicone gaskets.
- Electronic ballast integrated in the body.
- PMMA lenses with narrow beam ($8,5^\circ$ and $5,6^\circ$)
- White monochromatic LEDs available in 2 colour temperatures:
Warm = 3000K
Neutral = 4000K
- IP65 electrical connection device suitable for cables with a diameter between 6 and 13 mm and allowing the electrical interfacing with the external mains without need of opening the fixture.
- All fixing dowels used outside the fixture are in AISI 304 stainless steel.
- The components in die-cast aluminium and the steel bracket for wall fixing are painted by means of 3-stage outdoor treatment: nanotechnologies, antioxidant primer, polyester paint.
- Technical features of light fixtures in compliance with EN60598-1.
- IP Rating IP65.
- Insulation class II.



Calumet ceiling

- Made up of cylindrical body, lighting cap and ceiling fixing flange.
- Cylindrical body in EN AW-6060 aluminium containing the electronic power supply components.
- Optical lighting body in EN AW-6060 aluminium
- Led and collimator lenses which swing by means of an aluminium bracket.
- Diffuser in toughened glass
- Water tight silicone gaskets.
- EN AW-6060 aluminium flange to fix the light fixture to the ceiling.
- Electronic ballast integrated in the body.
- PMMA lenses with narrow beam (8° and 38,2°)
- White monochromatic LEDs available in 2 colour temperatures:
Warm = 3000K
Neutral = 4000K
- IP65 electrical connection device suitable for cables with a diameter between 6 and 13 mm and allowing the electrical interfacing with the external mains without need of opening the fixture.
- All fixing dowels used outside the fixture are in AISI 304 stainless steel.
- The components in die-cast aluminium and the steel bracket for wall fixing are painted by means of 3-stage outdoor treatment: nanotechnologies, antioxidant primer, polyester paint.
- Technical features of light fixtures in compliance with EN60598-1.
- IP Rating IP65.
- Insulation class II.

Calumet 8 wall

Grey-white RAL9002

Anthracite grey



						One emission
W	Beam	CCT	CRI	Flux	Color	Code
4 W	7,8°	3000 K	80	184 lm		T41911NW00
		4000 K	80	253 lm		T41911NW10
						T41911NN00
						T41911NN10



						Double emission
W	Beam	CCT	CRI	Flux	Color	Code
8 W	2x7,8°	3000 K	80	369 lm		T41922NW00
		4000 K	80	506 lm		T41922NW10
						T41922NN00
						T41922NN10

IP65 IK06

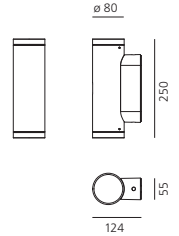

220/240Vac 50/60Hz electronic ballast included

4 W				8 W					
		4000 K	$\alpha=7,8^\circ$			4000 K	$\alpha=2X7,8^\circ$		
	H	\varnothing	EMax	EM		H	\varnothing	EMax	EM
	m	m	lux	lux		m	m	lux	lux
	1	0,14	7525	4929		1	0,14	7525	4929
	2	0,28	1881	1232		2	0,28	1881	1232
	3	0,41	836	548		3	0,41	836	548
	4	0,55	470	308		4	0,55	470	308
	5	0,69	301	197		5	0,69	301	197

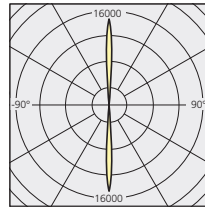
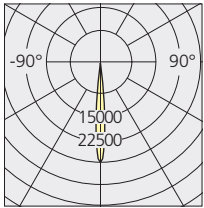

Calumet 13 wall

						One emission
W	Beam	CCT	CRI	Flux	Color	Code
8 W	6°	3000 K	80	366 lm		T41941NW00
		4000 K	80	392 lm		T41941NW10
						T41941NN00
						T41941NN10



						Double emission
W	Beam	CCT	CRI	Flux	Color	Code
16 W	2x6°	3000 K	80	732 lm		T41952NW00
		4000 K	80	784 lm		T41952NW10
						T41952NN00
						T41952NN10

IP65 IK09

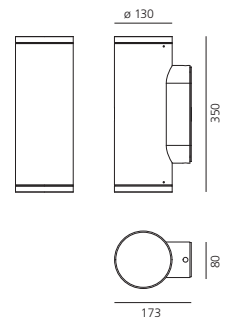

220/240Vac 50/60Hz electronic ballast included

8 W				16 W					
		4000 K	$\alpha=6^\circ$			4000 K	$\alpha=2x6^\circ$		
	H	\varnothing	EMax	EM		H	\varnothing	EMax	EM
	m	m	lux	lux		m	m	lux	lux
	1	0,10	21441	13555		1	0,10	21441	13555
	2	0,19	5360	3389		2	0,19	5360	3389
	3	0,29	2382	1506		3	0,29	2382	1506
	4	0,39	1340	847		4	0,39	1340	847
	5	0,49	858	542		5	0,49	858	542

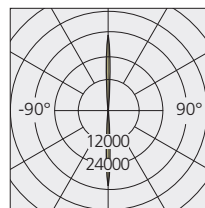
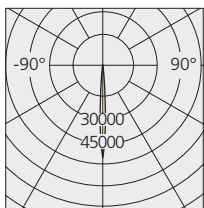

— C = 0°-180° Cd/Klm
 C = 90°-270°

— C = 0°-180° Cd/Klm
 C = 90°-270°

Calumet 8 ceiling

Grey-white RAL9002

Anthracite grey

W	Beam	CCT	CRI	Flux	Color
4 W	25°	3000 K	80	189 lm	○
		4000 K	80	260 lm	●

Code
T41931LW00
T41931LW10
T41931LN00
T41931LN10

220/240Vac 50/60Hz electronic ballast included



IP65 IK06

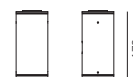

4 W 4000 K $\alpha=25^\circ$

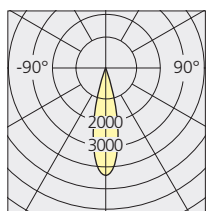

H m	Ø m	EMax lux	EM lux
1	0,44	1132	729
2	0,89	283	182
3	1,33	126	81
4	1,78	71	46
5	2,22	45	29

— C = 0°-180° Cd/Klm
 C = 90°-270°

Calumet 13 ceiling

W	Beam	CCT	CRI	Flux	Color
8 W	38°	3000 K	80	321 lm	○
		4000 K	80	344 lm	●

Code
T41961LW00
T41961LW10
T41961LN00
T41961LN10

220/240Vac 50/60Hz electronic ballast included



IP65 IK09

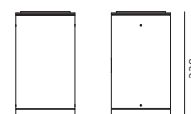

8 W 4000 K $\alpha=38^\circ$

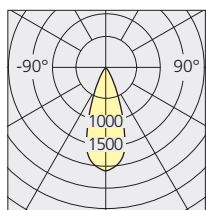

H m	Ø m	EMax lux	EM lux
1	0,69	721	447
2	1,39	180	112
3	2,08	80	50
4	2,77	45	28
5	3,47	29	18

— C = 0°-180° Cd/Klm
 C = 90°-270°

Molla

Ernesto Gismondi
2011



- Light fixture with 2 combined light beams: the large one with lighting function and the narrow one with decorative function.
- Wall installation. The fixture can be installed with the main beam pointed either downwards or upwards according to the kind of lighting desired (direct or indirect).
- The large beam is obtained by the combination of a monochromatic LED light source with a reflector. The narrow beam is obtained by the combination of a monochromatic LED light source with a high-performance projector.
- Available in two finishes: light grey and anthracite grey painted.
- Consists of lighting cap unit and terminal board fixed together by means of locking screws.
- Cap and terminal board in die-cast EN AB-47100 aluminium.
- Watertight gasket in silicone rubber.
- Electronic ballast integrated in the fixture.
- Projector consists of a body in reinforced polymer and PMMA lenses.
- Tempered and silkscreened light-diffusing glasses, siliconed flush with the lighting cap.
- Power connection to the mains to be carried out outside the fixture, without the need to open it, by means of a pre-installed IP65 connection device suitable for cables with a diameter between 6 and 13 mm.
- Wall fixing by means of a bracket in folded steel sheet to which the fixture is fastened with two screws.
- Locking screws used outside the fixture in AISI 316 stainless steel.
- Die-cast aluminium and bracket painted with 3-stage outdoor treatment: nanotechnologies, antioxidant primer, polyester paint.
- Technical features of light fixtures in compliance with EN60598-1.
- IP Rating IP65.
- ENEC approved.
- Insulation class II.

Molla

Grey-white RAL9002
○

Anthracite grey
●

W	CCT	Flux	CRI	Beam	Color	Code
10 W - 3 W	3000 K	350 lm - 55 lm	82 - 80	90° - 8°	○	T4190NLW00
	4000 K	400 lm - 63 lm	80 - 75	90° - 8°	●	T4190NLW10
					○	T4190NLN00
					●	T4190NLN10



220/240Vac 50/60Hz electronic ballast included

IP65

13 W 4000 K $\alpha=90^\circ-8^\circ$

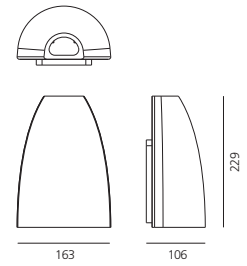
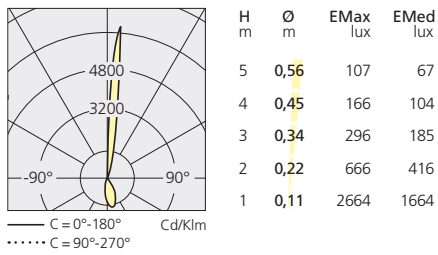

Pantarei

Ernesto Gismondi
1993, 2012



- Series of light fixtures with diffuse emission, with LED sources.
- Wall and ceiling installation.
- 3 sizes (190, 300 e 390mm).
- Available in two finishes: silver grey and black painted.
- Available with two types of diffusers:
 - Honeycomb moulded diffuser in internally sanded sodium-calcium glass;
 - Honeycomb moulded prismatic shock resistant diffuser in opal polycarbonate.
- Pantarei 190 can be provided with half-light screen.
- Pantarei 300 LED available with microwaves movement detector adjustable from 2 to 10 m and from 10 to 30 minutes, and with daylight sensor adjustable from 10 to 500 lux.
- Lamp unit in die-cast EN-AB 46100 aluminium with 3-stage outdoor treatment: nanotechnologies, antioxidant primer, polyester paint.
- AISI 316 stainless steel screws and silicone seal gaskets.
- Suitable for watertight connection.
- Technical features of light fixtures in compliance with EN60598-1.
- IP Rating IP65.
- ENEC approved.
- Insulation class I.



Pantarei 190

Black ● Silver grey ●

Sanded glass IK06

W	Flux	CCT	CRI	Color	Code
10 W	381 lm	3000 K	80	●	T277630
				●	T277690

Opal polycarbonate IK10

W	Flux	CCT	CRI	Color	Code
10 W	243 lm	3000 K	80	●	T277730
				●	T277790

220/240Vac 50/60Hz electronic ballast included

Opal polycarbonate

10 W 3000 K

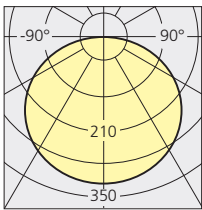

— C = 0°-180° Cd/Klm
 C = 90°-270°

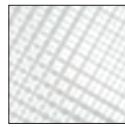

Sanded glass diffuser

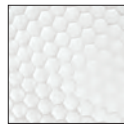

Opal polycarbonate diffuser

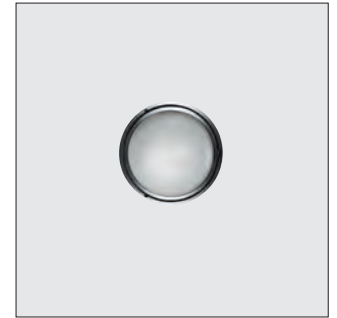

IP65 IK06/IK10

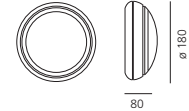

Pantarei 300

Sanded glass IK06

W	Flux	CCT	CRI	Color	Code
13 W	497 lm	3000K	85	●	T2778130
				●	T2778190
				sens.pres + daylight ●	T2780130
				●	T2780190
532lm	4000K	80	●	T277830	
			●	T277890	
			sens.pres + daylight ●	T278030	
			●	T278090	

Opal polycarbonate IK10

W	Flux	CCT	CRI	Color	Code
13 W	544 lm	3000K	85	●	T2779130
				●	T2779190
				sens.pres + daylight ●	T2781130
				●	T2781190
582lm	4000K	80	●	T277930	
			●	T277990	
			sens.pres + daylight ●	T278130	
			●	T278190	

220/240Vac 50/60Hz electronic ballast included

Opal polycarbonate

13 W 3000 K

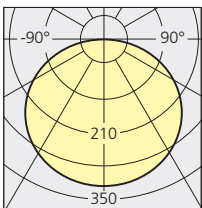

— C = 0°-180° Cd/Klm
 C = 90°-270°

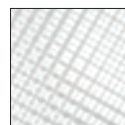

Sanded glass diffuser



Opal polycarbonate diffuser

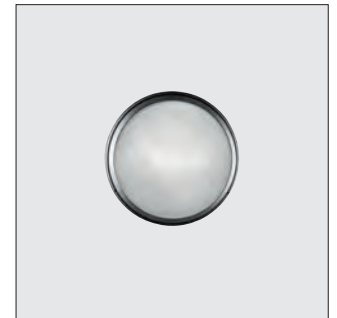

IP65 IK06/IK10

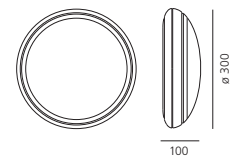

Pantarei 390

Black ● Silver grey ●

Sanded glass IK06					Code
W	Flux	CCT	CRI	Color	
30 W	960 lm	3000 K	80	●	T278230
				●	T278290

Opal polycarbonate IK10					Code
W	Flux	CCT	CRI	Color	
30 W	1000 lm	3000 K	80	●	T278330
				●	T278390

220/240Vac 50/60Hz electronic ballast included

Opal polycarbonate

30 W 3000 K

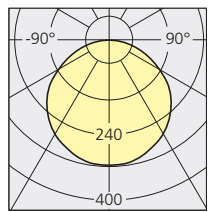

— C = 0°-180° Cd/Klm
 C = 90°-270°

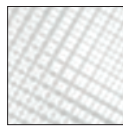

Sanded glass diffuser

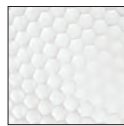

Opal polycarbonate diffuser

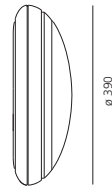
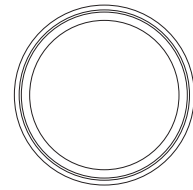

IP65 IK06/IK10





- Light fixture with diffuse emission, with LED sources.
- Wall and ceiling installation.
- LED version available with microwaves movement detector adjustable from 2 to 10 m and from 10 to 30 minutes, and with daylight sensor adjustable from 10 to 500 lux.
- Lamp unit in AISI316 stainless steel.
- Moulded covering frame in AISI316 stainless steel, satiny or polished finish.
- Available with two types of diffusers:
 - Moulded prismatic diffuser in sodium-calcium glass with internal satin finish;
 - Moulded prismatic shock resistant diffuser in opal UV-stabilized thermoplastic material.
- AISI 316 stainless steel screws and polyurethane seal gaskets.
- Suitable for watertight connection.
- Electronic ballast.
- IP Rating IP65.
- ENEC approved.
- Insulation class I.



Niki glass

Satiny
○

Polished
●

LED

W	Flux	CCT	CRI	Color	Code
13 W	483 lm	3000 K	85	<input type="radio"/>	L2280180
				<input checked="" type="radio"/>	L2280190
				detector + daylight	L2282180
				<input checked="" type="radio"/>	L2282190
	517 lm	4000 K	80	<input type="radio"/>	L228080
				<input checked="" type="radio"/>	L228090
				detector + daylight	L228280
				<input checked="" type="radio"/>	L228290



220/240Vac 50/60Hz electronic ballast included

IP65 IK06

13 W 4000 K

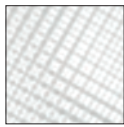
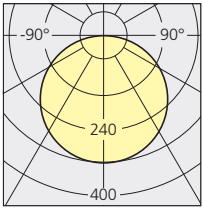

Prismatic glass diffuser

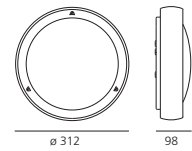

Niki polycarbonate

LED

W	Flux	CCT	CRI	Color	Code
13 W	443 lm	3000 K	85	<input type="radio"/>	L2281180
				<input checked="" type="radio"/>	L2281190
				detector + daylight	L2283180
				<input checked="" type="radio"/>	L2283190
	580 lm	4000 K	80	<input type="radio"/>	L228180
				<input checked="" type="radio"/>	L228190
				detector + daylight	L228380
				<input checked="" type="radio"/>	L228390



220/240Vac 50/60Hz electronic ballast included

IP65 IK10

13 W 4000 K

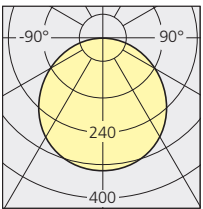

Opal polycarbonate diffuser

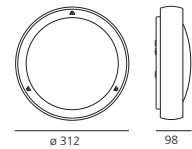

Niki glass

Satiny
○

Polished
●

HALO/FLUO

W	Color	Code
HALO max 1x52W (E27) - ECO	○	L221180
	●	L221190
FLUO 2x18W (G24d-2) - TC-DEL	○	L220480
	●	L220490
FLUO 1x18W (G24d-2) - TC-DEL	○	L222180
emergency	●	L222190



IP65 IK06

220/240Vac 50/60Hz electronic ballast included

52 W HALO

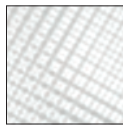
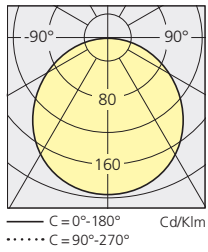

Prismatic glass diffuser

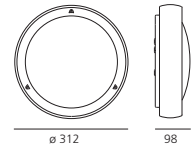

Niki polycarbonate

FLUO

W	Color	Code
FLUO 2x18W (G24d-2) - TC-DEL	○	L225480
	●	L225490
FLUO 2x18W (G24d-2) - TC-DEL	○	L227180
emergency	●	L227190



IP65 IK10

220/240Vac 50/60Hz electronic ballast included

2x18 W FLUO

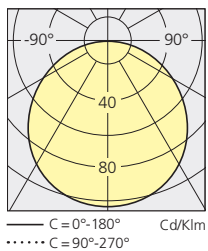

Opal polycarbonate diffuser

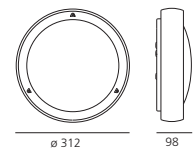



- Wall and ceiling light fixture with diffuse emission, with fluorescent or halogen sources.
- Available in 4 sizes (ø14, ø25, ø35 e ø42 cm).
- Wall support in thermoplastic resin.
- Acid-etched blown glass diffuser, milk white colour.
- Silicone seal gaskets.
- Suitable for watertight connection.
- Technical features of light fixtures in compliance with EN60598-1.
- IP Rating IP65.
- ENEC approved.
- Insulation class II.



Dioscuri 14

White
○

HALO

HALO max 1x60W (G9) - ECO

Color
○

Code
1039010A

Voltage 220/240Vdc 50/60Hz

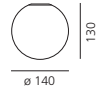

IP65  

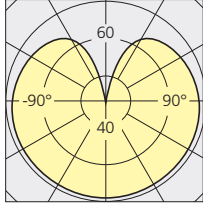

— C = 0°-180° Cd/Klm
..... C = 90°-270°

Dioscuri 25

HALO/FLUO/LED

HALO max 1x70W (E27) - ECO

FLUO 1x20W (E27) - TC-TSE

LED max 17W (E27)

Voltage 220/240Vdc 50/60Hz

Color
○

Code
0112010A

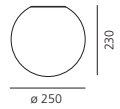

IP65  

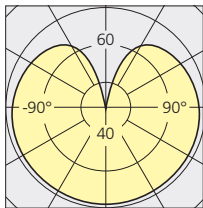

— C = 0°-180° Cd/Klm
..... C = 90°-270°

Dioscuri 35

White



HALO/FLUO/LED

HALO max 1x105W (E27) - ECO
FLUO 1x23W (E27) - TC-TSE
LED max 17W (E27)

Voltage 220/240Vdc 50/60Hz

Color



Code

0116010A

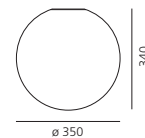

IP65  

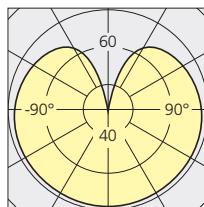

— C = 0°-180° Cd/Klm
..... C = 90°-270°

Dioscuri 42

HALO/FLUO/LED

HALO max 1x105W (E27) - ECO
FLUO 1x23W (E27) - TC-TSE
LED max 17W (E27)

Voltage 220/240Vdc 50/60Hz

Color



Code

0117010A

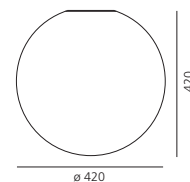
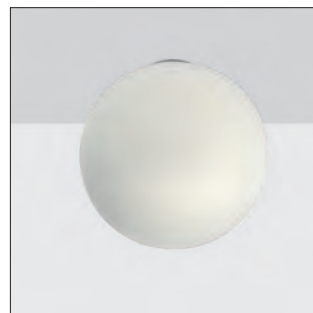

IP65  

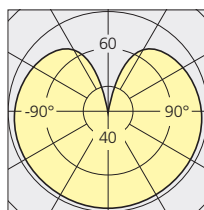

— C = 0°-180° Cd/Klm
..... C = 90°-270°



- Wall/ceiling light fixture with diffuse emission, with fluorescent or halogen light sources.
- Horizontal or vertical installation.
- Available in two finishes: silver grey painted and black painted.
- Lamp unit in die-cast EN-AB 46100 aluminium with 3-stage outdoor treatment: nanotechnologies, antioxidant primer, polyester paint.
- Reflector in bright anodized aluminium.
- Moulded diffuser in internally sanded sodium-calcium glass with transparent profile.
- The fixture can be provided with directional screen in bright anodized aluminium.
- Stainless steel screws and silicone seal gaskets.
- Suitable for watertight connection.
- Technical features of light fixtures in compliance with EN60598-1.
- IP Rating IP65.
- ENEC approved.
- Insulation class II.

Mitasi

Black

Silver grey



HALO/FLUO

W	Color	Code
HALO max 2x28W (E14) - ECO	●	T052310
	●	T052390
220/240Vac 50/60Hz main voltage		
	●	T052210
FLUO 1x26W (G24d-3) - TC-D	●	T052290
220/240Vac 50/60Hz main voltage.		
Directional screen.		T087100

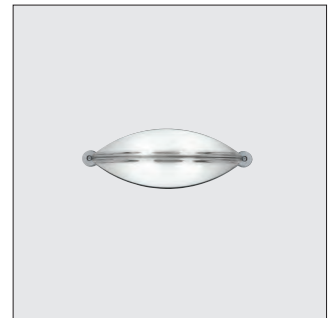

IP65

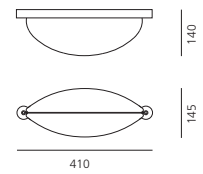
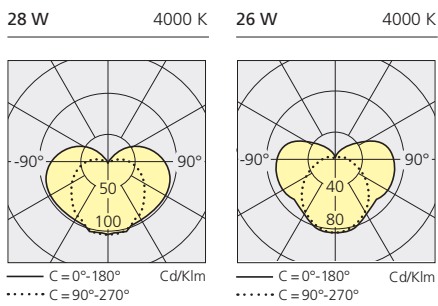

Cuneo Cuneo Mini

Klaus Begasse
2010, 2015



- Light fixture with direct side emission, with high-performance LED light sources. Six monochromatic LEDs are used together with six collimators and a light-diffusing prismatic screen to obtain an optimum lighting beam.
- Floor or wall installation. In the wall installation, the light can be pointed either upwards or downwards.
- Available in two finishes: light grey and rust painted.
- Consists of lighting cap and terminal board fixed together by means of locking screws.
- Cap and terminal board in die-cast EN AB-47100 aluminium, gaskets in silicone rubber. Electronic ballast integrated in the fixture.
- Cuneo: PMMA collimators installed on the LED light sources. Light-diffusing prismatic screen in PMMA siliconed flush with the lighting cap.
- Cuneo Mini: High-yield COB LED source with high-reflection anodized aluminium body. Etched tempered glass screen glued flush to the lighting body with silicon.
- Power connection to the mains to be carried out outside the fixture, without the need to open, by means of a pre-installed IP65 connection device suitable for cables with a diameter between 6 and 13 mm.
- Wall installation by means of a bracket in folded steel sheet to which the fixture is fastened with two screws.
- Screws in AISI 316 stainless steel.
- All the components in die-cast aluminium and the steel bracket for wall or floor fixing are painted by means of 3-stage outdoor treatment: nanotechnologies, antioxidant primer, polyester paint.
- Technical features of light fixtures in compliance with EN60598-1.
- IP Rating IP65.
- ENEC approved.
- Insulation class II.

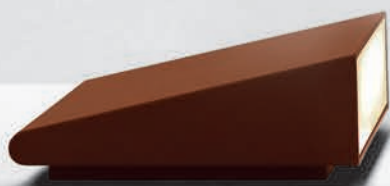

Cuneo

Grey-white RAL9002

Rust

W	Flux	CCT	CRI	Beam	Color	Code
17 W	668 lm	4000 K	75	14,6°x63,4°	○	T082900
					●	T082910

Electronic power supply 220 / 240Vac 50 / 60Hz included.



11 W 4000 K $\alpha=14,6^\circ \times 63,4^\circ$

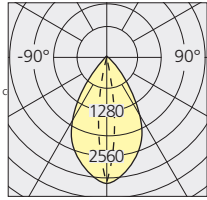

— C = 0°-180° Cd/Klm
 C = 90°-270°

IP65

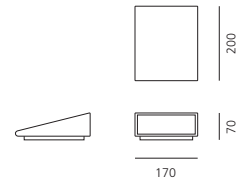

The elliptical light emission and the flat shape of the fixture make it particularly suitable for floors or spacious areas in gardens to provide a side lighting.



Cuneo mini

Grey-white RAL9002
○

Rust
●

W	Flux	CCT	CRI	Beam	Color	Code
11W	650 lm	3000 K	80	55,2°x79,4°	○	T082800
					●	T082810



Electronic power supply 220 / 240Vac 50 / 60Hz included.

17 W 3000 K α=55,2°x79,4°

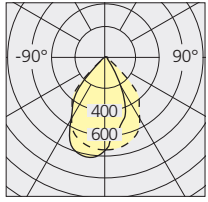

H m	Ø m	EMax lux	EM lux
1	1,69	542	257
2	3,37	135	64
3	5,06	60	29
4	6,74	34	16
5	8,43	22	10

— C = 0°-180° Cd/Klm
 C = 90°-270°

IP65 □

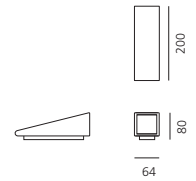



Basolo

Ernesto Gismondi
2014

- Floor and ceiling asymmetrical wallwasher light fixture with a roto-symmetrical option, only available for the ceiling version. The ceiling version is also available with downlight optics with high visual comfort (UGR<19).
- Fixture consisting of cubic body and floor / ceiling fixing plate. Ceiling version includes a security cable.
- Body made in die-cast aluminium EN-AB 44100 with 3-stage outdoor treatment: nanotechnologies, antioxidant primer, polyester paint.
- Wallwasher version also available in a movable version with 4 solid support legs.
- Includes a metal-finish polycarbonate reflector.
- Diffuser in tempered silk-screened glass.
- AISI 316 fixing screws and silicon gaskets.
- IP rating: IP67. Class I
- Supplied with H05RN-F 3X1 cable and IP67 network connector using 5-13.5 diameter cables, housed in a compartment in the lower part of the fixture.
- Technical features in compliance to EN60598-1.
- EC Certificate.



Basolo

Anthracite grey



Basolo wall washer

W	Flux	CCT	CRI	Color
27 W	2067 lm	3000 K	80	○

Fixed

Code
T419700W00

Mobile

Code
T440000W00

220/240Vac 50/60Hz electronic ballast included

17 W 3000 K $\alpha=54^\circ \times 57,4^\circ$

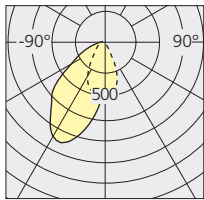

H m	Ø m	EMax lux	EM lux
1	1,19	1920	893
2	2,38	480	223
3	3,57	213	99
4	4,77	120	56
5	5,96	77	36

cd/klm



IP67 IK06

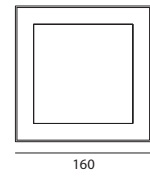
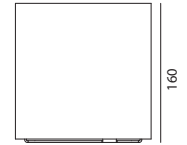

Basolo soffitto

W	Flux	CCT	CRI	Color
28 W	2089 lm	3000 K	80	○

Code
T440100W00

220/240Vac 50/60Hz electronic ballast included

28 W 3000 K

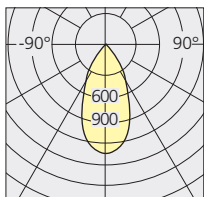

IP67 IK06

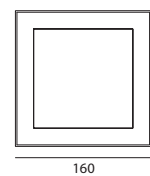
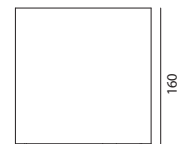

Illo Catilina Aglaia

Sergio Mazza

Series of light fixtures with diffuse emission,
with halogen or fluorescent sources.
Floor, wall and ceiling installation.



Illo

- Ceiling installation.
- Lamp unit in die-cast EN-AB 46100 aluminium with 3-stage outdoor treatment: nanotechnologies, antioxidant primer, polyester paint.
- Reflector in bright anodised aluminium.
- Diffuser in opal blown glass.
- Stainless steel screws and silicone seal gaskets.
- Suitable for watertight connection.
- Technical features of light fixtures in compliance with EN60598-1.
- IP Rating IP44.
- ENEC approved.
- Insulation class I.

Catilina

- Wall or floor installation.
- Lamp unit in die-cast EN-AB 46100 aluminium with 3-stage outdoor treatment: nanotechnologies, antioxidant primer, polyester paint.
- Reflector in bright anodised aluminium.
- Diffuser in opal blown glass.
- Stainless steel screws and silicone seal gaskets.
- Suitable for watertight connection.
- Technical features of light fixtures in compliance with EN60598-1.
- IP Rating IP44.
- ENEC approved.
- Insulation class I.

Aglaia

- Floor installation.
- Lamp unit in die-cast EN-AB 46100 aluminium with 3-stage outdoor treatment: nanotechnologies, antioxidant primer, polyester paint.
- Reflector in bright anodised aluminium.
- Diffuser in opal blown glass.
- Pole in painted aluminium.
- Stainless steel screws and silicone seal gaskets.
- Suitable for watertight connection.
- Technical features of light fixtures in compliance with EN60598-1.
- IP Rating IP44.
- ENEC approved.
- Insulation class I.



HALO/FLUO/LED

W	Color	Code
HALO max 1x70 W (E27) - ECO		T053110
FLUO 1x20 W (E27) - TC-TSE		
LED max 17 W (E27)		

220/240Vac 50/60Hz electronic ballast included

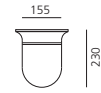
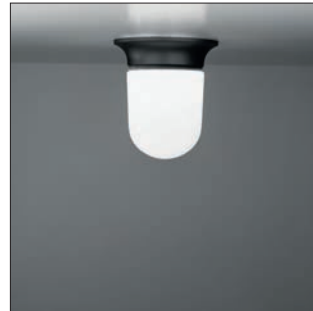

IP44

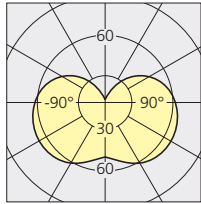

— C = 0°-180° Cd/Klm
 C = 90°-270°

Catilina

HALO/FLUO/LED

W	Color	Code
HALO max 1x70 W (E27) - ECO		T053010
FLUO 1x20 W (E27) - TC-TSE		
LED max 17 W (E27)		

220/240Vac 50/60Hz electronic ballast included

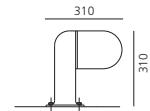
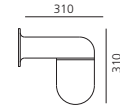

IP44

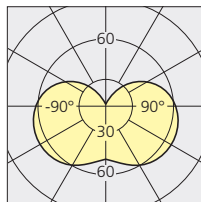

— C = 0°-180° Cd/Klm
 C = 90°-270°

Aglaia

HALO/FLUO/LED

W	Color	Code
HALO max 1x70 W (E27) - ECO		T052010
FLUO 1x20 W (E27) - TC-TSE		
LED max 17 W (E27)		

220/240Vac 50/60Hz electronic ballast included

Pole H 50 cm	T053710
Pole H 100 cm	T053810
Floor mounting plate	T053900

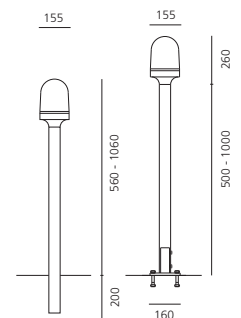
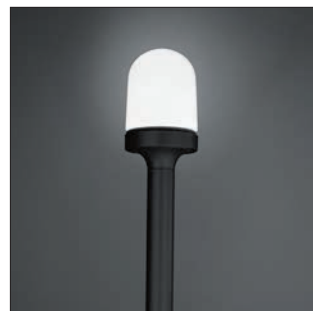

IP44

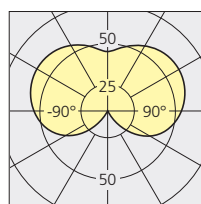

— C = 0°-180° Cd/Klm
 C = 90°-270°

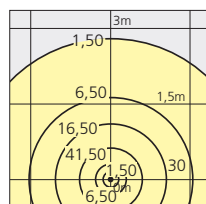

h = 56 Lux

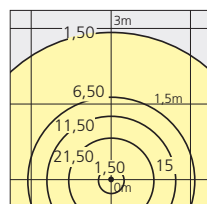

h = 76 Lux

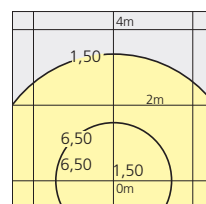

h = 126 Lux



Series of light fixtures with direct unilateral or bilateral emission, with high-performance LED light sources.

Floor and recessed installation.

Available in two finishes: grey-white painted and rust painted.

Nuda floor

- Available in unilateral and bilateral emission version and in two heights (h 50cm and h 100cm).
- Consist of lamp, support pole and ground mounting plate.
- Lamp unit in die-cast EN-AB 47100 aluminium.
- UV resistant diffuser in shock resistant polycarbonate with satin finish.
- Specular reflector in aluminium. It conveys and diffuses the luminous flow downwards to ensure visual comfort.
- Support pole in extruded EN-AW-6060 aluminium, chromate treated and painted.
- Mounting plate in folded, welded and painted steel, with holes for ground fixing by means of log bolts or dowels.
- Painting is obtained by means of 3-stage outdoor treatment: nanotechnologies, antioxidant primer, polyester paint.
- AISI 316 stainless steel screws and silicone seal gasket.
- Provided with IP67 cable and connector for the mains connection.
- Technical features of light fixtures in compliance with EN60598-1.
- IP Rating IP65.
- ENEC approved.
- Insulation class II.

Nuda recessed

- Consist of lamp and recessing box for recessed wall installation.
- Lamp unit in painted die-cast EN-AB 44100 aluminium, complete with holding plate for electrical components.
- Specular reflector in aluminium. It conveys and diffuses the luminous flow downwards to ensure visual comfort.
- UV resistant diffuser in shock resistant polycarbonate with satin finish.
- Aesthetic cover in painted aluminium.
- Painting is obtained by means of 3-stage outdoor treatment: nanotechnologies, antioxidant primer, polyester paint.
- AISI 316 stainless steel screws and silicone seal gasket.
- Provided with IP67 cable and connector suitable for H07RN-F cables with a diameter from 5 to 13.5 mm for the mains connection.
- Recessing box in reinforced polymer, can be ordered separately.
- Technical features of light fixtures in compliance with EN60598-1.
- IP Rating IP65.
- ENEC approved.
- Insulation class II.



Nuda

Nuda floor 50 unilateral

LED 8,5 W			Lighting application		
h	L	a	Em	E _{max}	E _{min}
0.5 m	0.5 m	1.8 m	52 lux	178 lux	0.5 lux

Nuda floor 100 unilateral

LED 17 W			Lighting application		
h	L	a	Em	E _{max}	E _{min}
1.0 m	1.0 m	2.5 m	24 lux	66 lux	0.5 lux

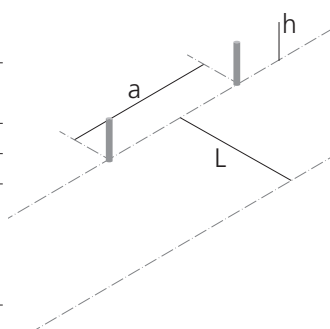

Nuda floor 50 bilateral

LED 8,5 W			Lighting application		
h	L	a	Em	E _{max}	E _{min}
0.5 m	0.5 m	1.8 m	16 lux	72 lux	0.5 lux

Nuda floor 100 bilateral

LED 17 W			Lighting application		
h	L	a	Em	E _{max}	E _{min}
1.0 m	1.0 m	2.5 m	7 lux	26 lux	0.5 lux

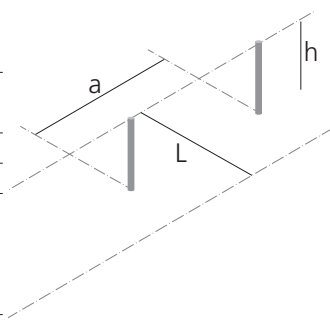

Recessed hole
200 x 260 x 60 mm



Recessing box
190 x 250 x 55 mm



Lighting unit



Aesthetic cover



Nuda

Grey-white RAL9002

Rust



Nuda recessed

W	Flux	CCT	CRI	Color	Code
8,5 W	180lm	3000K	80		T083500
					T083510

220/240Vac 50/60Hz electronic ballast included

Recessing box

T083400

8,5 W 3000 K

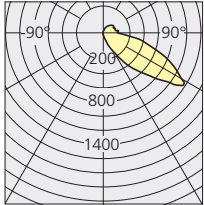

— C = 0°-180° Cd/Klm
 C = 90°-270°

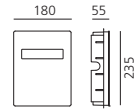
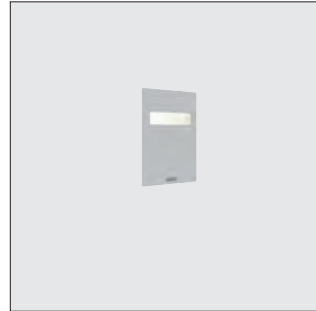

IP65 IK06

Nuda floor 50 unilateral

W	Flux	CCT	CRI	Color	Code
8,5 W	180 lm	3000K	80		T083600
					T083610

220/240Vac 50/60Hz electronic ballast included

8,5 W 3000 K

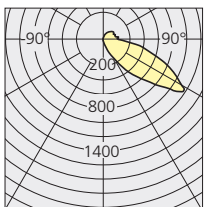

— C = 0°-180° Cd/Klm
 C = 90°-270°

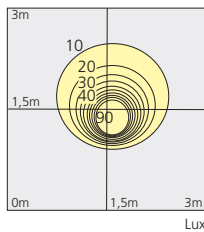

Lux

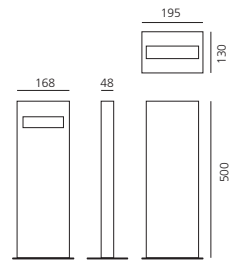

IP65 IK06

Nuda floor 50 bilateral

W	Flux	CCT	CRI	Color	Code
8,5 W	147 lm	3000 K	80		T083700
					T083710

220/240Vac 50/60Hz electronic ballast included

8,5 W 3000 K

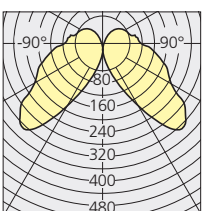

— C = 0°-180° Cd/Klm
 C = 90°-270°

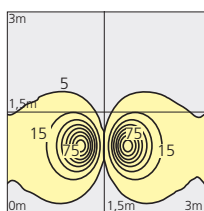

Lux

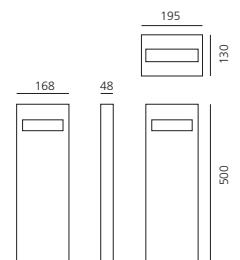

IP65 IK06

Nuda

Grey-white RAL9002

Rust



Nuda floor 100 unilateral

W	Flux	CCT	CRI	Color
17 W	306 lm	3000 K	80	<input type="radio"/>
				<input checked="" type="radio"/>

Code
T083800
T083810

220/240Vac 50/60Hz electronic ballast included

17 W 3000 K

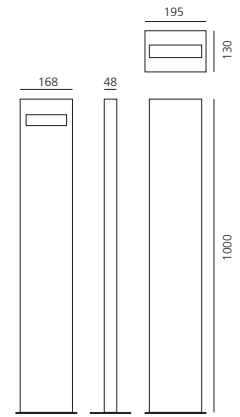
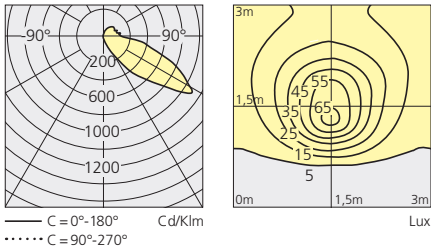

IP65 IK06

Nuda floor 100 bilateral

W	Flux	CCT	CRI	Color
17 W	250 lm	3000 K	80	<input type="radio"/>
				<input checked="" type="radio"/>

Code
T083900
T083910

220/240Vac 50/60Hz electronic ballast included

17 W 3000 K

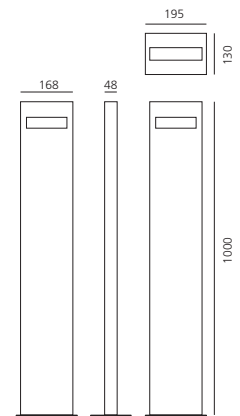
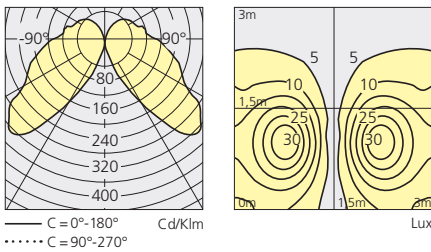

IP65 IK06

Ciclope

Alessandro Pedretti
(Studio Rota & Partners)
2009





Lighting system with diffuse unilateral or bilateral emission, with high-performance LED light sources.

Light emission is obtained by the combination of six monochromatic LED light sources, a reflector and an opaline diffuser.

Floor, wall or recessed installation.

Available in two finishes: light grey and rust painted.

Ciclope floor

- Available in unilateral and bilateral emission version and in two heights (h 50cm and h 90cm).
- Stem in extruded EN AW-6060 aluminium.
- Lighting unit consists of: frame in reinforced polymer; diffuser in light-diffusing polycarbonate; plate in pickled, machined and galvanised steel; watertight gasket in silicone rubber; LED circuit; electronic ballast; reflector in painted spun aluminium; PG13.5 cable gland, H05RN-F cable and IP65 electrical connection device suitable for cables with a diameter between 6 and 13 mm to allow electrical interfacing with the external mains without the need to open the fixture.
- The lighting unit houses the electrical components and sources.
- Aesthetic cover in die-cast EN AB-47100 aluminium.
- Ground mounting plate in folded, welded and painted steel, with holes for ground fixing by means of log bolts or dowels.
- The elements are fixed together by means of screws. All the locking screws used outside the fixture and inside the stem are in AISI 304 stainless steel.
- The components in die-cast, extruded aluminium and steel are painted by means of 3-stage outdoor treatment: nanotechnologies, antioxidant primer, polyester paint.
- Technical features of light fixtures in compliance with EN60598-1.
- IP Rating IP65.
- ENEC approved.
- Insulation class II.

Ciclope recessed

- Lighting unit consists of: frame in reinforced polymer; diffuser in light-diffusing polycarbonate; plate in pickled, machined galvanised steel; watertight gasket in silicone rubber; LED circuit; electronic ballast; reflector in painted, spun aluminium sheet PG13.5 cable gland, H05RN-F cable and IP65 electrical connection device suitable for cables with a diameter between 6 and 8.5 mm to allow electrical interfacing with the external mains without the need to open the fixture.
- The lighting unit houses the electrical components and sources.
- Aesthetic cover in die-cast EN AB-47100 aluminium painted by means of 3-stage outdoor treatment: nanotechnologies, antioxidant primer, polyester paint.
- Recessing box in reinforced polymer, can be ordered separately.
- The elements are fixed together by means of screws. All the locking screws used outside the fixture and inside the stem are in AISI 304 stainless steel.
- Technical features of light fixtures in compliance with EN60598-1.
- IP Rating IP65.
- ENEC approved.
- Insulation class II.

Ciclope wall

- Box in extruded EN AW-6060 aluminium.
- Lighting unit consists of: frame in reinforced polymer; diffuser in light-diffusing polycarbonate; plate in pickled, machined galvanised steel; watertight gasket in silicone rubber; LED circuit; electronic ballast; reflector in painted spun aluminium; PG13.5 cable gland, H05RN-F cable and IP65 electrical connection device suitable for cables with a diameter between 6 and 8.5 mm to allow electrical interfacing with the external mains without the need to open the fixture.
- The lighting unit houses the electrical components and sources.
- Aesthetic cover in die-cast EN AB-47100 aluminium.
- The elements are fixed together by means of screws. All the locking screws used outside the fixture and inside the stem are in AISI 304 stainless steel.
- The components in die-cast, extruded aluminium and steel are painted by means of 3-stage outdoor treatment: nanotechnologies, antioxidant primer, polyester paint.
- Technical features of light fixtures in compliance with EN60598-1.
- IP Rating IP65.
- ENEC approved.
- Insulation class II.

Ciclope

Ciclope floor 50 unilateral

LED 6W			Lighting application		
h	L	a	Em	E _{max}	E _{min}
0.5 m	1.0 m	3 m	59 lux	378 lux	1 lux

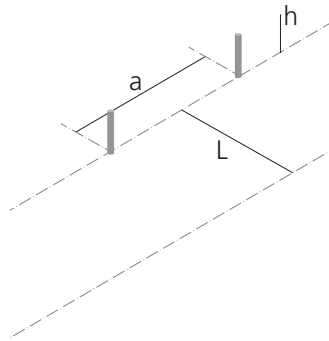

Ciclope floor 90 unilateral/bilateral

LED 6W			Lighting application		
h	L	a	Em	E _{max}	E _{min}
0.9 m	1.0 m	3.5 m	28 lux	87 lux	1 lux

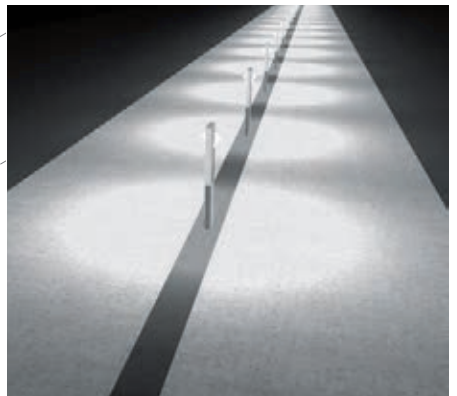
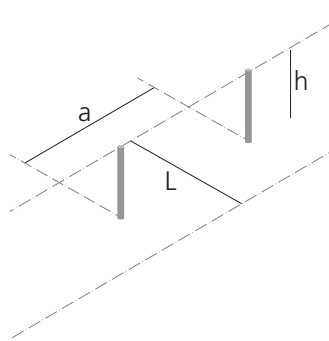
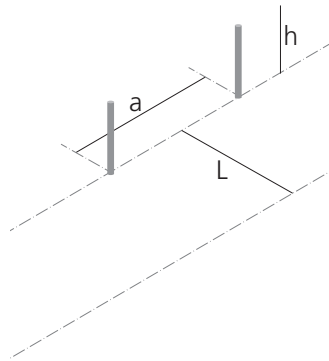

Ciclope wall/recessed

LED 6W			Lighting application		
h	L	a	Em	E _{max}	E _{min}
0.5 m	1.0 m	2.9 m	53 lux	401 lux	1 lux

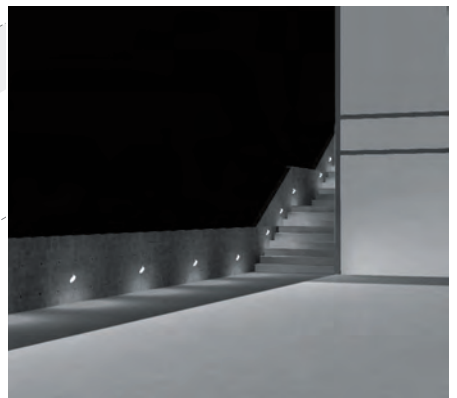
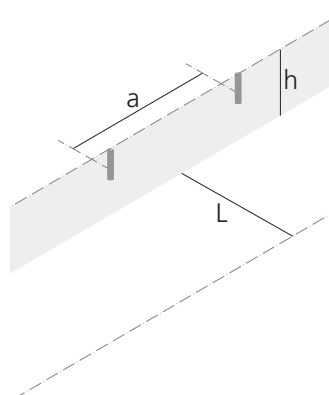



Ciclope

Grey-white RAL9002

Rust



Ciclope floor 50 Unilateral

W	Flux	CCT	CRI	Color	Code
6 W	284 lm	3000 K	80		T081000
					T081010

220/240Vac 50/60Hz electronic ballast included
Mounting plate included

6 W 3000 K

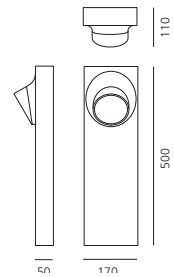
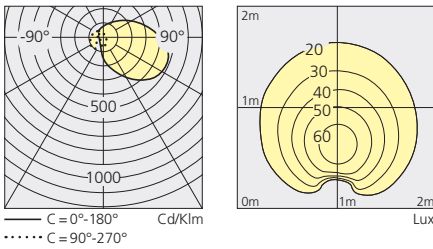

IP65 IK10

Ciclope floor 50 Bilateral

W	Flux	CCT	CRI	Color	Code
13 W	568 lm	3000 K	80		T081300
					T081310

220/240Vac 50/60Hz electronic ballast included
Mounting plate included

13 W 3000 K

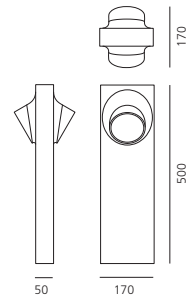
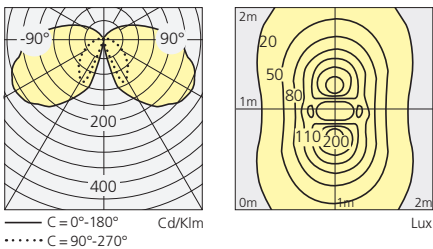

IP65 IK10

Ciclope floor 90 Unilateral

W	Flux	CCT	CRI	Color	Code
6 W	284 lm	3000 K	80		T081100
					T081110

220/240Vac 50/60Hz electronic ballast included
Mounting plate included

6 W 3000 K

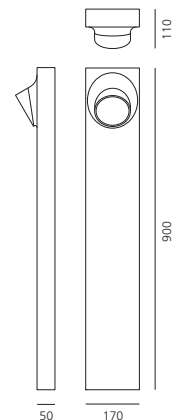
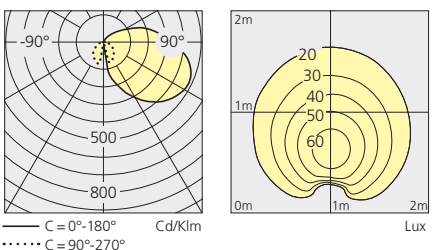

IP65 IK10

Ciclope

Grey-white RAL9002

Rust



Ciclope floor 90 Bilateral

W	Flux	CCT	CRI	Color	Code
13 W	568 lm	3000 K	80		T081400
					T081410

220/240Vac 50/60Hz electronic ballast included
Mounting plate included

13 W 3000 K

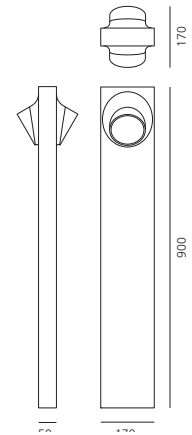
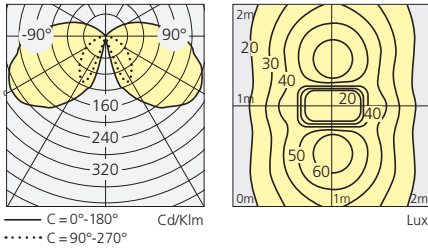

IP65 IK10

Ciclope recessed

W	Flux	CCT	CRI	Color	Code
6 W	284lm	3000 K	80		T081500
					T081510

220/240Vac 50/60Hz electronic ballast included
Recessing box supplied separately

Recessing box

T081600

6 W 3000 K

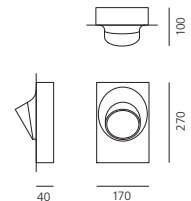
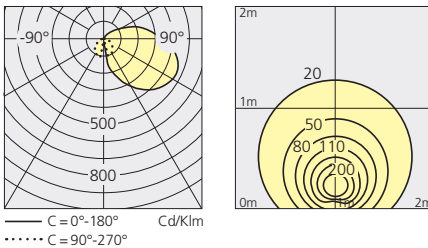

IP65 IK10



Recessed hole
230 x 330 x 50 mm



Recessing box
201 x 300 x 48,5 mm



Lighting unit



Aesthetic cover

Ciclope wall

W	Flux	CCT	CRI	Color	Code
6 W	284lm	3000 K	80		T081200
					T081210

220/240Vac 50/60Hz electronic ballast included
Wall support included

6 W 3000 K

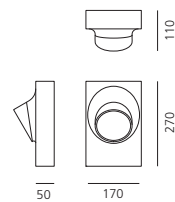
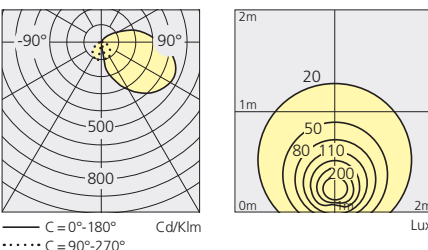

IP65 IK10

Chilone

Ernesto Gismondi
2009



Series of light fixtures with direct emission,
with high-performance LED light sources.
Floor, pole or wall installation.

Available in two finishes: light grey painted
and rust painted.

Chilone wall

- It can be installed with the light pointed either downwards or upwards.
- Consists of lamp, lamp support and wall support.
- Lamp unit in die-cast EN-AB 47100 aluminium.
- UV resistant diffuser in shock resistant polycarbonate with satiny finish.
- Lamp support in extruded EN-AW-6060 aluminium.
- Wall support in steel.
- Painting is obtained by means of 3-stage outdoor treatment: nanotechnologies, antioxidant primer, polyester paint.
- AISI 316 stainless steel screws and silicone seal gasket.
- Provided with IP67 cable and connector for the mains connection.
- Technical features of light fixtures in compliance with EN60598-1.
- IP Rating IP65.
- ENEC approved.
- Insulation class II.
- Wall support included

Chilone pole

- Height 250 cm
- Consists of lamp, lamp support and ground fixing pole.
- Lamp unit in die-cast EN-AB 47100 aluminium.
- UV resistant diffuser in shock resistant polycarbonate with satiny finish.
- Lamp support in extruded EN-AW-6060 aluminium.
- Ground fixing pole in painted extruded EN-AW-6060 aluminium. It must be installed by means of a proper foundation plinth.
- Painting is obtained by means of 3-stage outdoor treatment: nanotechnologies, antioxidant primer, polyester paint.
- AISI 316 stainless steel screws and silicone seal gasket.
- Provided with IP67 cable and connector for the mains connection.
- Technical features of light fixtures in compliance with EN60598-1.
- IP Rating IP65.
- ENEC approved.
- Insulation class II.

Chilone floor

- Available with downward emission in two heights (h4 5cm and h 90cm) and with upward emission (Chilone Up).
- Consists of lamp, support pole and ground mounting plate.
- Lamp unit in die-cast EN-AB 47100 aluminium.
- UV resistant diffuser in shock resistant polycarbonate with satiny finish.
- Support pole in extruded EN-AW-6060 aluminium, chromate treated and painted.
- Mounting plate in folded, welded and painted steel, with holes for ground fixing by means of log bolts or dowels.
- Painting is obtained by means of 3-stage outdoor treatment: nanotechnologies, antioxidant primer, polyester paint.
- AISI 316 stainless steel screws and silicone seal gasket.
- Provided with IP67 cable and connector for the mains connection.
- Technical features of light fixtures in compliance with EN60598-1.
- IP Rating IP65.
- ENEC approved.
- Insulation class II.



Chilone

Chilone floor 45

LED 8 W			Lighting application		
h	L	a	Em	E _{max}	E _{min}
0.45 m	1.0 m	3.0 m	43 lux	842 lux	1 lux

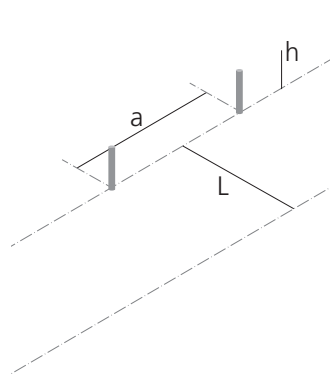

Chilone floor 90

LED 8 W			Lighting application		
h	L	a	Em	E _{max}	E _{min}
0.90 m	1.0 m	4.0 m	16 lux	96 lux	1 lux

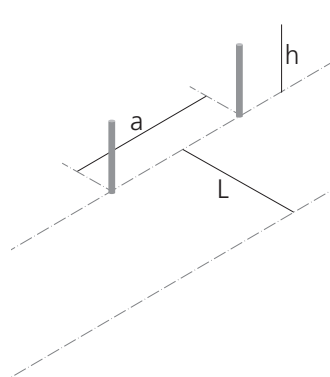

Chilone pole

LED 16 W			Lighting application		
h	L	a	Em	E _{max}	E _{min}
2.50 m	2.5 m	9 m	4 lux	9 lux	0.6 lux

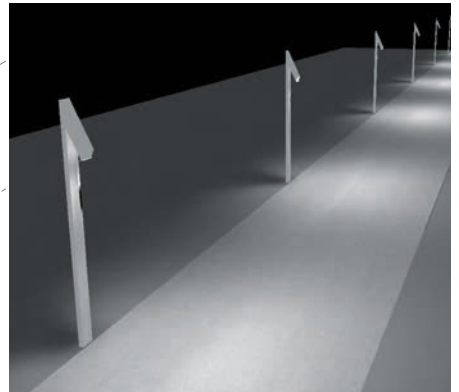
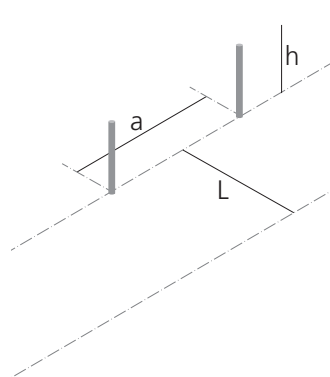



Chilone

Grey-white RAL9002

Rust



Chilone floor 45

W	Flux	CCT	CRI	Color	Code
8 W	194 lm	3000 K	80		T082200
					T082210

220/240Vac 50/60Hz electronic ballast included

Mounting plate included

8 W 3000 K

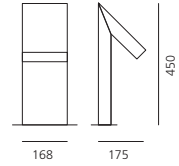
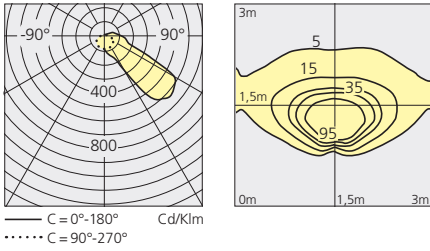

IP65

Chilone floor 90

W	Flux	CCT	CRI	Color	Code
8 W	194 lm	3000 K	80		T082100
					T082110

220/240Vac 50/60Hz electronic ballast included

Mounting plate included

8 W 3000 K

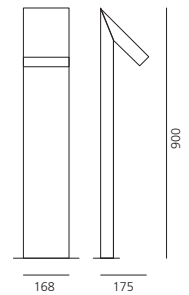
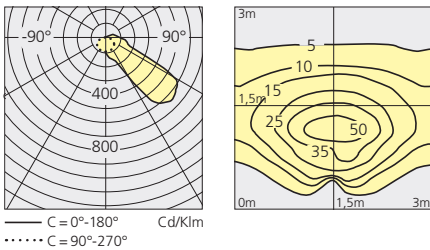

IP65

Chilone up

W	Flux	CCT	CRI	Color	Code
17 W	515 lm	3000 K	80		T082300
					T082310

220/240Vac 50/60Hz electronic ballast included

Mounting plate included

17 W 3000 K

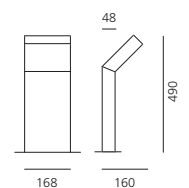
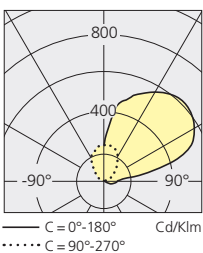

IP65

Chilone

Grey-white RAL9002

Rust



Chilone pole

W	Flux	CCT	CRI	Color	Code
17 W	515 lm	3000 K	80		T082000
					T082010

220/240Vac 50/60Hz electronic ballast included

Ground pole included

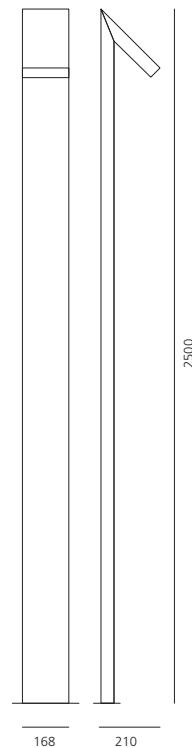
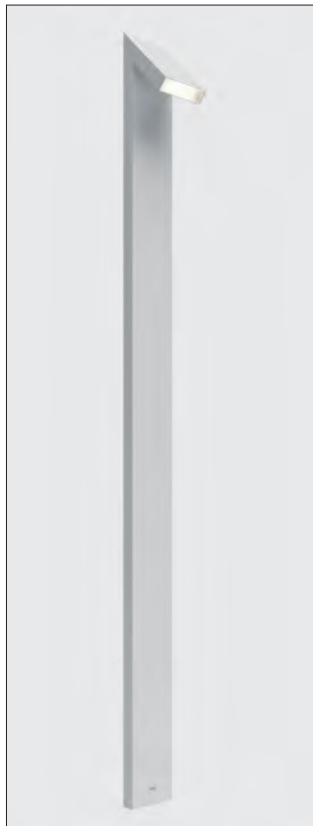

IP65

17 W 3000 K

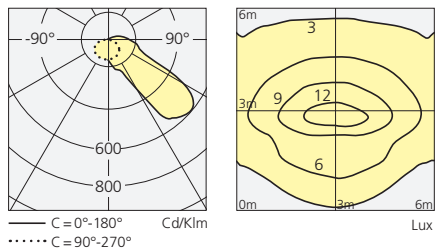

Chilone wall

W	Flux	CCT	CRI	Color	Code
17 W	515 lm	3000 K	80		T082400
					T082410

220/240Vac 50/60Hz electronic ballast included

Wall support included

17 W 3000 K

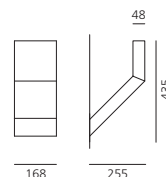
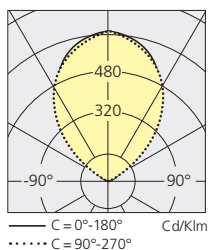

IP65



Tetragono floor

- Consists of lamp and supporting pole.
- Lamp support in extruded EN-AW-6060 aluminium, subjected to chromate treatment and painted, height 900mm, with painted steel base flange, with holes for floor installation by means of log bolts or dowels.
- Lighting unit in die-cast EN-AB 47100 aluminium painted with 3-stage outdoor treatment: nanotechnologies, anti-oxidising primer, polyester paint.
- Provided with metalised polycarbonate reflectors.
- UV resistant diffuser in shock resistant polycarbonate with bright finish.
- AISI 316 fixing screws and silicone gaskets.
- Provided with cable and IP67 connector for the connection to the mains suitable for 5-13.5mm diameter cables.
- IP Rating IP65.
- Insulation class I.
- Technical features in compliance with EN60598-1.

Tetragono wall

- Light fixture with radial light emission.
- Consists of body and wall fixing plate.
- Lamp support in extruded EN-AW-6060 aluminium, subjected to chromate treatment and painted, height 50 mm, with painted steel base flange, with holes for wall installation.
- Lighting unit in die-cast EN-AB 47100 aluminium painted with 3-stage outdoor treatment: nanotechnologies, anti-oxidising primer, polyester paint.
- Provided with metalised polycarbonate reflectors.
- UV resistant diffuser in shock resistant polycarbonate with bright finish.
- AISI 316 fixing screws and silicone gaskets.
- Provided with cable and IP67 connector for the connection to the mains suitable for 5-13.5mm diameter cables.
- IP Rating IP65.
- Insulation class I.
- Technical features in compliance with EN60598-1.



Tetragono

Anthracite grey



Tetragono floor 45

W	Flux	CCT	CRI	Color	Code
15 W LED COB	437 lm	3000 K	80	●	T417100W00

220/240Vac 50/60Hz electronic ballast included

15 W 3000 K

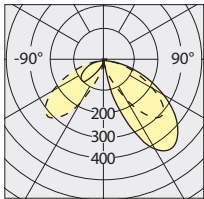

— C = 0°-180° Cd/Klm
 - - C = 90°-270°

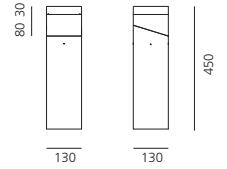

IP65 IK10

Tetragono floor 90

W	Flux	CCT	CRI	Color	Code
15 W LED COB	437 lm	3000 K	80	●	T417200W00

220/240Vac 50/60Hz electronic ballast included

15 W 3000 K

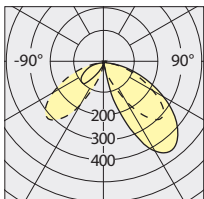

— C = 0°-180° Cd/Klm
 - - C = 90°-270°

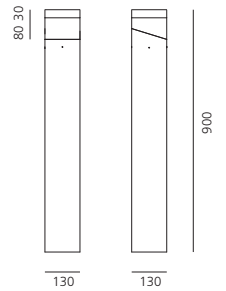

IP65 IK10

Tetragono wall

W	Flux	CCT	CRI	Color	Code
15 W LED COB	437 lm	3000 K	80	●	T417300W00

220/240Vac 50/60Hz electronic ballast included

15 W 3000 K

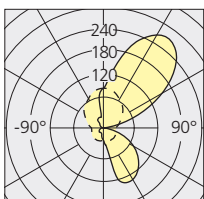

— C = 0°-180° Cd/Klm
 - - C = 90°-270°

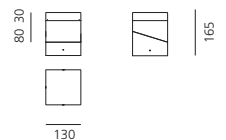

IP65 IK10





- Light fixture with direct emission, with high-performance monochromatic LED light sources.
- Floor installation.
- Grey-white RAL9002 finish.
- Consists of support with lamp compartment, lamp and accessory compartment.
- Lamp unit in die-cast EN-AB 47100 aluminium, painted with 3-stage outdoor treatment: nanotechnologies, antioxidant primer, polyester paint.
- UV resistant diffuser in transparent shock resistant polycarbonate.
- Painted trapezoidal lamp support in vibrated concrete, with galvanized reinforcing ring for fixing to the base.
- Accessory compartment in polymers with closure cover in AISI 316.
- Hot galvanised steel mounting plate, with holes for ground fixing by means of log bolts or dowels.
- AISI 316 stainless steel screws and silicone seal gasket.
- Provided with IP67 cable and connector for the mains connection.
- Technical features of light fixtures in compliance with EN60598-1.
- IP Rating IP65.
- ENEC approved.
- Insulation class II.

Eraclea

Grey-white RAL9002



W	Flux	CCT	CRI	Color	Code
8 W	320 lm	3000 K	80	○	T085300

220/240Vac 50/60Hz electronic ballast included



IP65  

8 W 4000 K

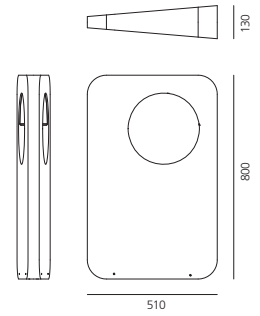
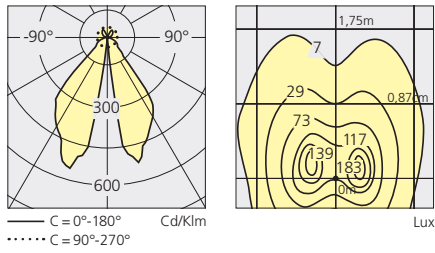

Ippolito

Alessandro Pedretti
(Studio Rota & Partners)
2011



- Light fixture with direct emission, with a unique high-performance monochromatic COB LED.
- Floor installation.
- Available in two heights (h 45cm and h 90cm).
- Consists of support with lamp compartment, lamp and ballast compartment.
- Cylindrical lamp support in engineering polymer (compact polyurethane), with co-moulded galvanised steel reinforcing elements. Painted with polyurethane resistant to atmospheric and chemical agents.
- Fixture head in die-cast EN-AB 47100 aluminium, painted with 3-stage outdoor treatment: nanotechnologies, antioxidant primer, polyester paint.
- UV resistant diffuser in transparent shock resistant polycarbonate.
- Accessory compartment in polymers with closure cover in AISI 316.
- Hot galvanised steel mounting plate, with holes for ground fixing by means of log bolts or dowels.
- AISI 316 stainless steel screws and silicone seal gasket.
- Provided with IP67 cable and connector for the mains connection.
- Technical features of light fixtures in compliance with EN60598-1.
- IP Rating IP65.
- Insulation class II.

Ippolito

Anthracite grey/light grey



Ippolito 45

W LED COB	Flux	CCT	CRI	Color	Code
15 W	1060 lm	3000 K	80	●	T085100

220/240Vac 50/60Hz electronic ballast included



IP65 IK10

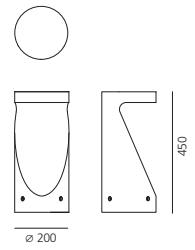

Ippolito 90

W LED COB	Flux	CCT	CRI	Color	Code
15 W	1130 lm	3000 K	80	●	T085000

220/240Vac 50/60Hz electronic ballast included



IP65 IK10

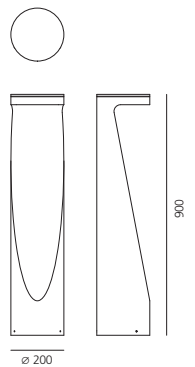

Logico Garden

Michele De Lucchi, Daniele Moioli
2014

- Floor fitting.
- Designed for garden or pedestrian path lighting.
- The appliance consists of a lamp and a supporting pole. The lamp support -450, 600, or 900 mm high - is made of chromed and painted EN-AW-6060 extruded aluminium. The base flange is made of painted electro galvanized iron, with holes for ground fixing by means of screws or plugs.
- The lamp body is made of EN-AB 47100 die-cast aluminium with 3-stage outdoor treatment: nanotechnologies, anti-oxidising primer, polyester painting.
- Metallised polycarbonate reflectors. Highly transparent methacrylate screen, with shiny shock-resistant and anti-UV finish. AISI 316 fixing screws and silicon seals.
- Sealing rating IP65.
- Class I.
- Provided with cable and IP68 connector for connection to the mains cables with 5 to 13.5 mm diameters.
- Technical specifications comply with EN60598-1.
- EC certification.





red dot design award
2015

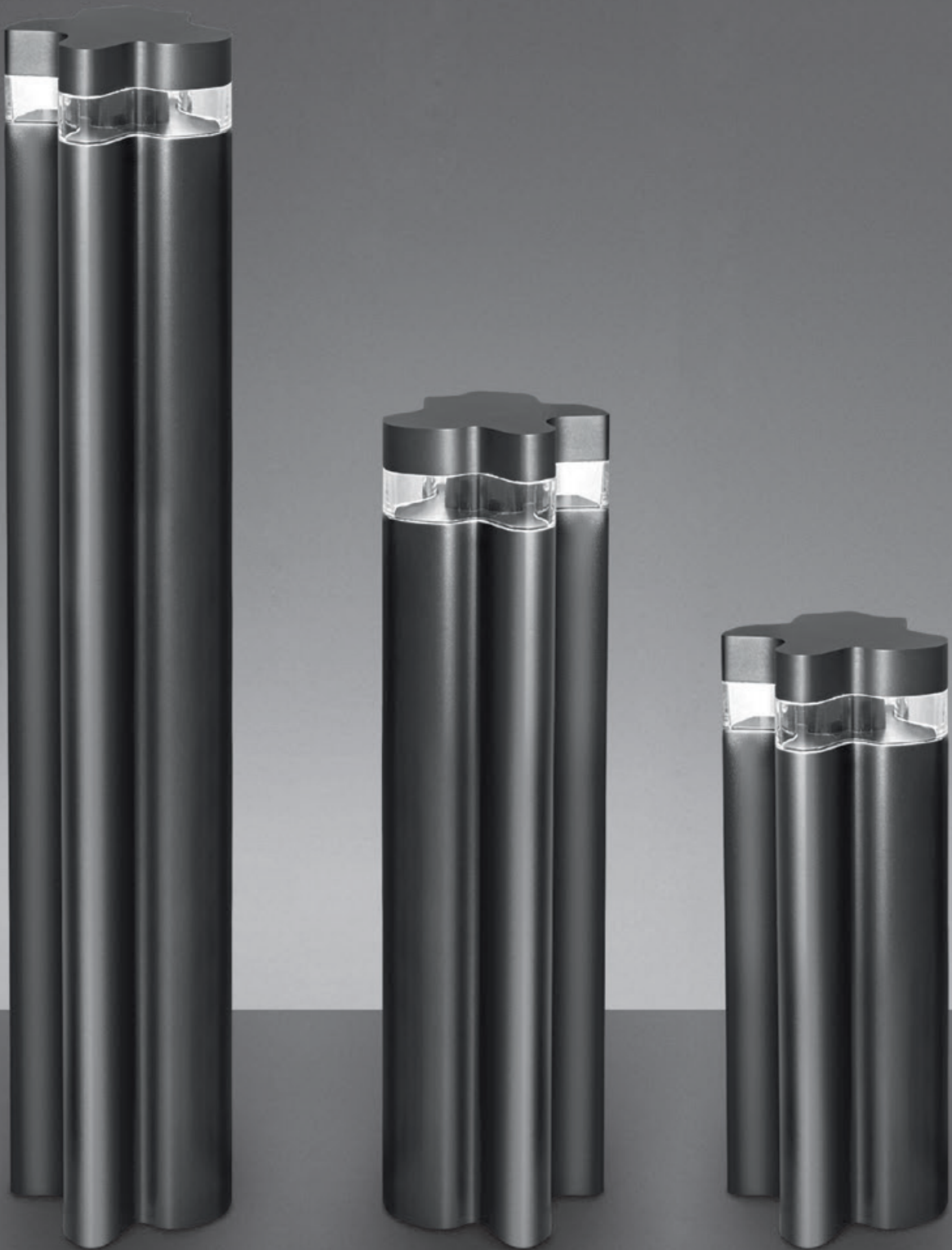



Logico Garden 45

W	CCT	CRI	Flux	Color	Code
15 W	3000 K	80	294 lm	●	T416800W00



IP65 IK10

15 W 3000 K

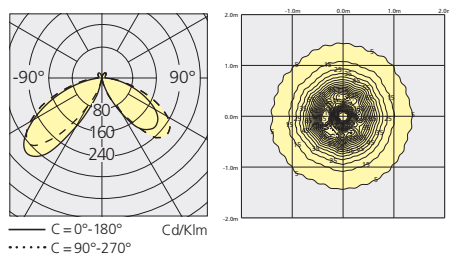

Logico Garden 60

W	CCT	CRI	Flux	Color	Code
15 W	3000 K	80	294 lm	●	T416900W00

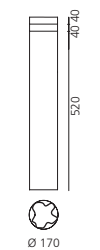

IP65 IK10

15 W 3000 K

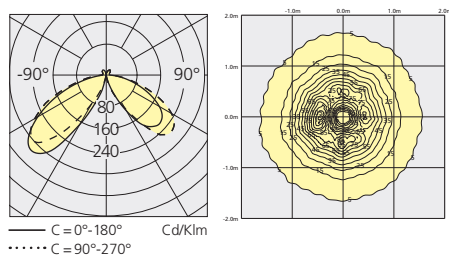



Logico Garden 90

W	CCT	CRI	Flux	Color
15 W	3000 K	80	294 lm	●

Code
T417000W00

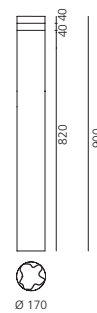

IP65 IK10

15 W 3000 K

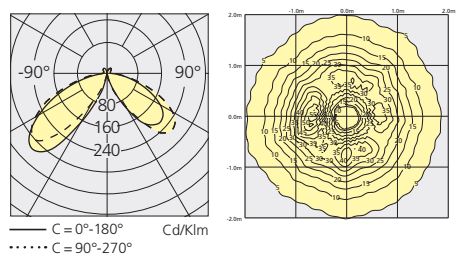

Logico Garden 3x120

W	CCT	CRI	Flux	Color
45 W	3000 K	80	899 lm	●

Code
T416700W00

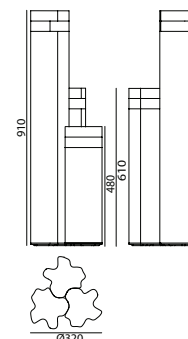

IP65 IK10

45 W 3000 K

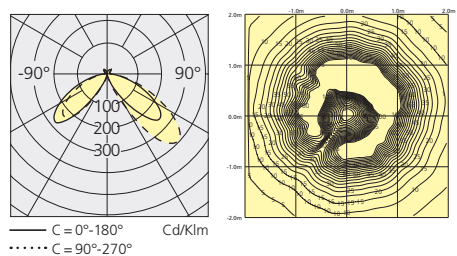

Piroscafo

Ernesto Gismondi
2014



- Lighting appliance for ground fixing with directional light emission, using monochrome LED light sources.
- The appliance consists of a body and a fixing base of EN-AB 47100 die-cast aluminium finished with a 3-stage outdoor treatment: nanotechnologies, anti-oxidising primer, polyester painting.
- Shock-resistant tempered glass screen.
- Sealing rating IP65.
- Class II
- Provided with cable and IP67 connector for connection to the mains. Supports cables with 7 to 12 mm diameters.
- Technical specifications comply with the EN60598-1 norm.

Piroscafo

Grey ● Green ● Rust ●

W	CCT	CRI	Flux	Color	Code
15 W	3000 K	80	1290 lm	●	T081910
				●	T081900
				●	T081920

220/240Vac 50/60Hz electronic ballast included



IP65

15 W 3000 K

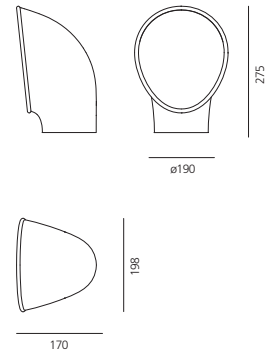
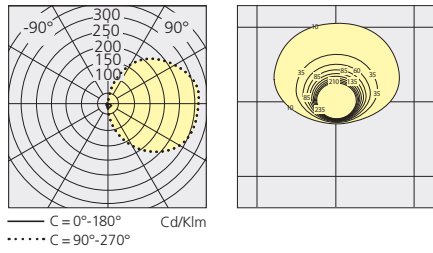

Granito

Ernesto Gismondi
2010

- Light fixture with metal halide sources.
- The four light beams projected through the fissures on the sides make it particularly suitable for lighting drives or creating light effects in parks and gardens.
- Available in two heights (h 30cm and h 60cm).
- Lamp unit in Cor-ten (weathering steel).
- Transparent sodium-calcium bulb protection glass.
- Ground mounting plate in steel with 3-stage outdoor treatment: nanotechnologies, antioxidant primer, polyester paint.
- AISI 316 stainless steel screws and silicone seal gaskets.
- Electronic ballast.
- Suitable for watertight connection.
- Technical features of light fixtures in compliance with EN60598-1.
- IP Rating IP65.
- ENEC approved.
- Insulation class II.



Granito

Rust Cor-ten



Granito 30

W

METAL HALIDE 1x35W (G12) – HIT

Color

Code

T083000

220/240Vac 50/60Hz electronic ballast included



IP55 IK10

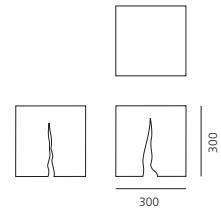

Granito 60

W

METAL HALIDE 1x35W (G12) – HIT

Color



Code

T083100

220/240Vac 50/60Hz electronic ballast included

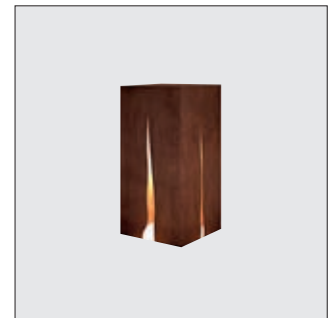

IP55 IK10

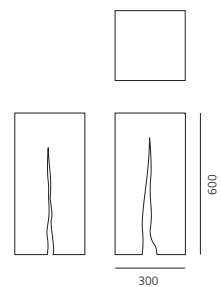

The colour of Cor-ten steel may change in time depending on weather conditions. Before stabilization, Cor-ten steel may release rust powder that may stain the surface where it is placed.

Artemide recommends not to position it on sensitive surfaces, such as clear stones, marbles, etc.







- Floor light fixture with diffuse emission, with monochromatic LED light sources.
- Available with IP20 protection rating for indoors, IP67 and IP68 for outdoors.
- Light is diffused through 7 PMMA rods with different heights to give the impression of a reed bed and which can be screwed to the base by means of AISI 316 stainless steel bushes. Part of the light is also diffused on the floor around the base.
- The base has an irregular shape, which has been designed to allow a «mosaic» connection with other light fixtures so as to create an elaborate composition as needed.
- IP67 and IP68 versions are available in Single or Triple shape.

Reeds IP20

- Consists of a base made up of a transparent polycarbonate casing
- Installed between 2 aluminium plates and anti-scratch support feet.
- Technopolymer aesthetic cover.
- Complete with integrated ballast and plug with transparent cable. Switching on and off are performed by means of the pedal push button located on the cable.
- Technical features in compliance with EN60598-1
- Insulation class II.

Reeds IP67

- Consists of a base made up of a transparent polycarbonate casing installed between 2 AISI316 stainless steel plates fixed by means of AISI316 stainless steel screws. Water sealing is assured by a silicone gasket. The light fixture can be fastened to the floor by means of the holes in the lower plate. Technopolymer aesthetic cover.
- Complete with integrated ballast and supplied with a 1.5 m-long H05RN-F 2x1 cable provided with IP67 connector for the electrical connection to the mains suitable for 5-13.5mm diameter cables.
- Technical features in compliance with EN60598-1
- Insulation class II.

Reeds IP68

- Consists of a base made up of a transparent polycarbonate casing installed between 2 AISI316 stainless steel plates fixed by means of AISI316 stainless steel screws. Water sealing is assured by a silicone gasket. The light fixture can be fastened to the floor by means of the holes in the lower plate. Technopolymer aesthetic cover.
- The light fixture is supplied with 24V DC power and is provided with a 5 m-long H05RN-F 2x1 cable with IP68 connector for the electrical connection to the mains suitable for 5-13.5mm diameter cables.
- Technical features in compliance with EN60598-1 and section 2-18.
- Insulation class III.



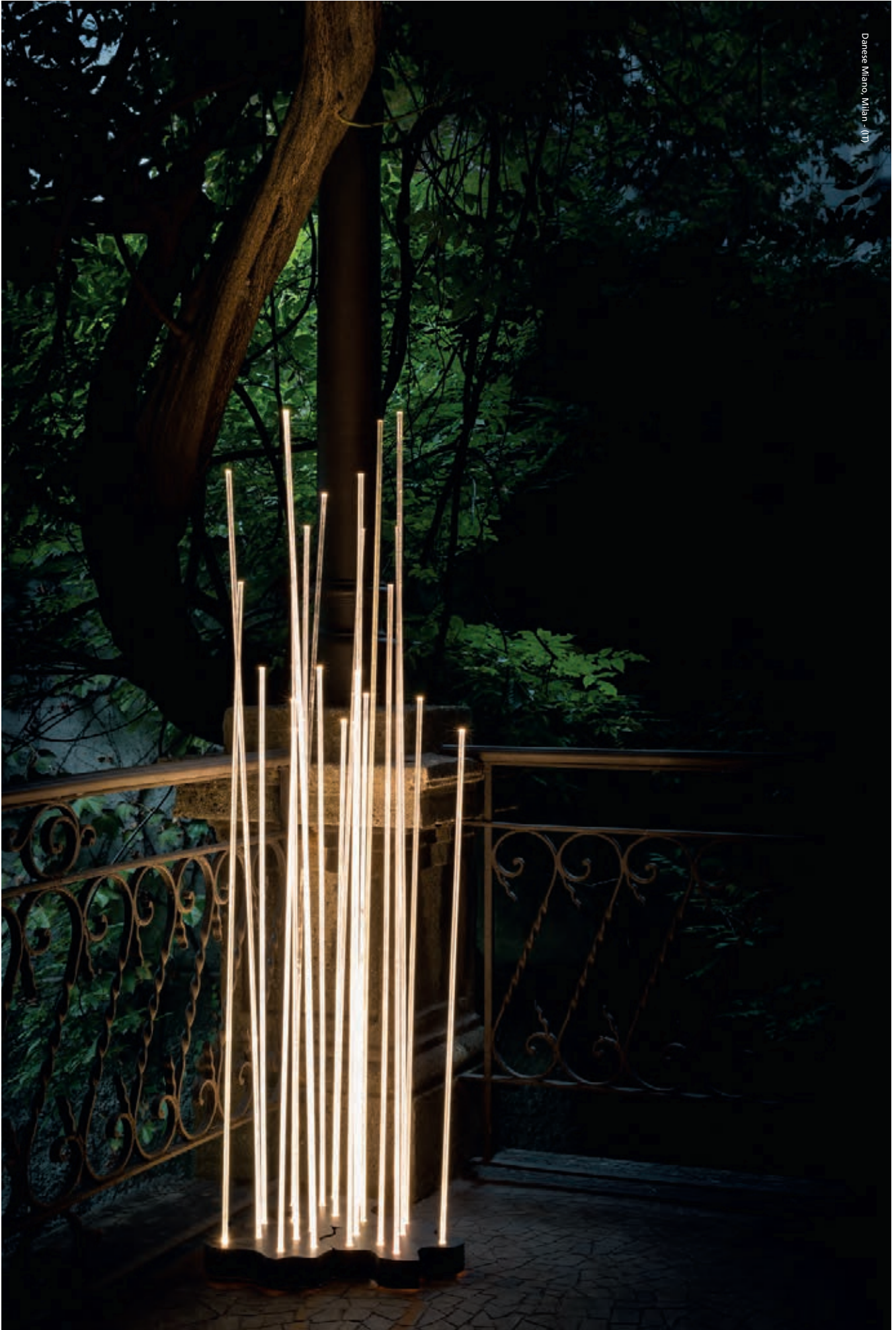

Reeds

Anthracite grey



IP20

W	Flux	CCT	CRI	Color	Code
9,5 W	79 lm	3000 K	80	●	T087300

220/240Vac 50/60Hz electronic ballast included

9,5 W 3000 K

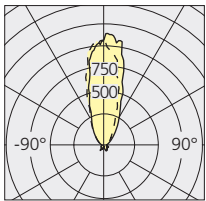

H m	Ø m	EMax lux	EMed lux
5	3,19	4	2
4	2,55	8	3
3	1,92	10	6
2	1,28	22	13
1	0,64	89	51

— C = 0°-180° Cd/Klm
 - - C = 90°-270°



IP20 IK10

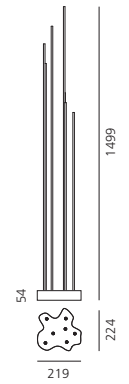

IP67

W	Flux	CCT	CRI	Color	Code
9,5 W	79 lm	3000 K	80	●	T087400

220/240Vac 50/60Hz electronic ballast included

9,5 W 3000 K

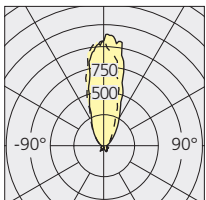

H m	Ø m	EMax lux	EMed lux
5	3,19	4	2
4	2,55	8	3
3	1,92	10	6
2	1,28	22	13
1	0,64	89	51

— C = 0°-180° Cd/Klm
 - - C = 90°-270°



IP67 IK10

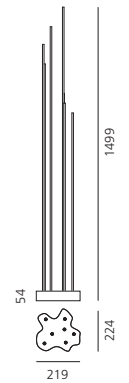

IP667 triple

W	Flux	CCT	CRI	Color	Code
28 W	237 lm	3000 K	80	●	T087700

220/240Vac 50/60Hz electronic ballast included

28 W 3000 K

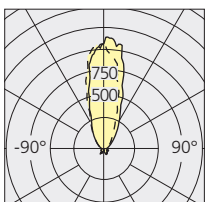

H m	Ø m	EMax lux	EMed lux
5	3,19	4	2
4	2,55	8	3
3	1,92	10	6
2	1,28	22	13
1	0,64	89	51

— C = 0°-180° Cd/Klm
 - - C = 90°-270°



IP67 IK10

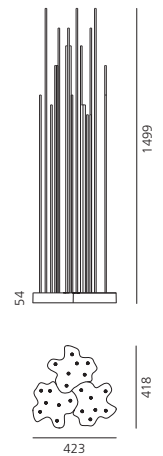

Reeds

Anthracite grey



IP68

W	Flux	CCT	CRI	Color	Code
9,5 W	79 lm	3000 K	80	●	T087500

Electronic ballast 24Vdc supplied separately

Driver	Vac in	Vac out	L _{mm}	W _{mm}	H _{mm}	IP	Code
25 W 24Vdc	110-277	24	150	40	32	67	T409996
60 W 24Vdc	110-277	24	165	43	32	67	T409998
90 W 24Vdc	110-277	24	165	61	36	67	T409999

Please see page 875 for drivers installation details.



IP68 IK10 □

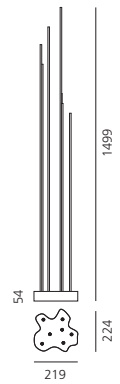

9,5 W

3000 K

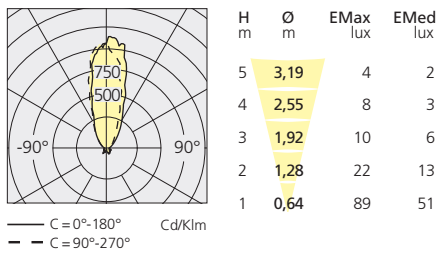

IP68 triple

W	Flux	CCT	CRI	Color	Code
28 W	237 lm	3000 K	80	●	T087800

Electronic ballast 24Vdc supplied separately

Driver	Vac in	Vac out	L _{mm}	W _{mm}	H _{mm}	IP	Code
60 W 24Vdc	110-277	24	165	43	32	67	T409998
90 W 24Vdc	110-277	24	165	61	36	67	T409999

Please see page 875 for drivers installation details.



IP68 IK10 □

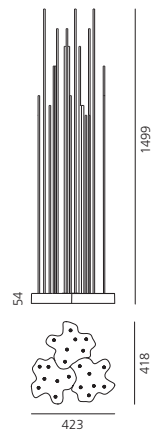

28 W

3000 K

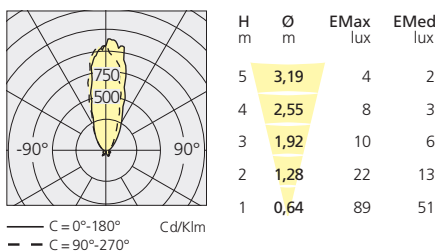



Places and Street Lighting	834	Tolomeo XXL
	838	Poto
	840	Hila
	844	Indicta
	848	Sostituto Pole
	850	Cefiso Pole
	854	Cariddi Pole
	856	Provoca
	860	Solar Tree

Tolomeo XXL

Michele De Lucchi
Giancarlo Piretti
2009



- Light fixture with direct emission, with fluorescent or metal halide sources.
- Available with base or fixed support (pivot) made of mass-coloured concrete.
- Diffuser in mass-pigmented polypropylene, screen in light-diffusing silkscreened methacrylate, reflector in painted aluminium.
- Mobile-arm structure in extruded EN-AW-6060 aluminium with bright anodizing treatment.
- Polished-painted articulations in die-cast EN-AB 46100 aluminium.
- Adjustment system in AISI 316 stainless steel.
- Silicone seal gaskets.
- Suitable for watertight connection.
- Electronic ballast.
- Technical features of light fixtures in compliance with EN60598-1.
- IP Rating IP65.
- ENEC approved.
- Insulation class I.



Tolomeo XXL

Silver grey

Tolomeo XXL with base

W	Color	Code
FLUO: 2x57W (GX24q-5)	●	1532010A
METAL HALIDE: 1x100W (E27) - HCl	●	1534010A

220/240Vac 50/60Hz electronic ballast included



IP55

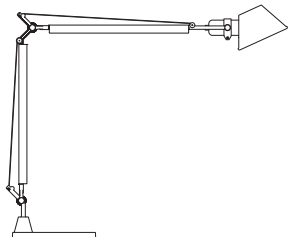

42 W

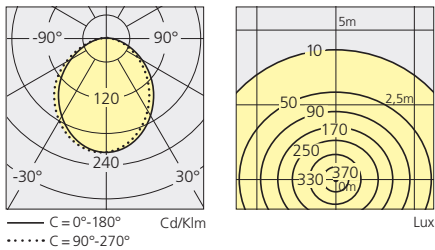

Cd/Klm

Lux

Tolomeo XXL with fixed support

W	Color	Code
FLUO: 2x57W (GX24q-5)	●	1535010A
METAL HALIDE: 1x100W (E27) - HCl	●	1536010A

220/240Vac 50/60Hz electronic ballast included



IP55

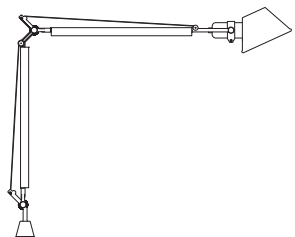

100 W

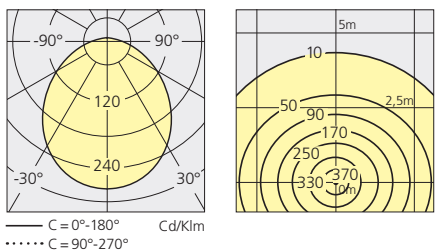

Cd/Klm

Lux

2920





- Pole appliance for direct lighting.
- Consists of a pole head attached to the pole with grub screws.
- The provided EN AW6060 aluminium pole should be bathed in concrete for 0.5m and rise 2.5m up from the ground.
- The lighting body is fitted with an IP67 connector supporting cables with 5 to 13.5 mm diameters, to be fitted inside the pole.
- The head has a transparent diffuser and a matt white top cap both in impact resistant PMMA. The body fitted inside the pole is made of EN AW6060 aluminium. Silicon seals.
- Electronic power pack fitted inside the body suited for 4kV surges.
- Internal reflector of metallised zamac fiited by sanded glass filter.
- All the screws used for the outside of the product are made of AISI 316 INOX steel.
- All the aluminium parts are finished with a 3-stage outdoor treatment: nanotechnologies, anti-oxidant primer, polyester paint.
- EC certification.
- Insulation class II

Poto

White
○

W	Flux	CCT	CRI	Color	Code
45 W	2586 lm	3000 K	80	○	T082600

220/240Vac 50/60Hz electronic ballast included



IP67 IK08

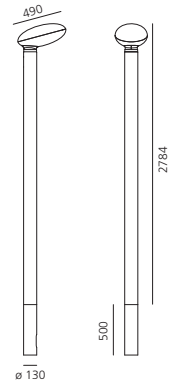

45 W 3000 K

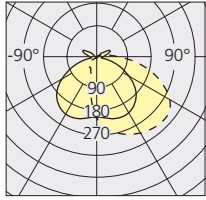

— C = 0°-180° Cd/Klm
- - - C = 90°-270°





Series of light fixtures with direct emission, with high-performance LED light sources.

Floor, pole and wall installation.

Grey-white finish.

Hila wall

- Consists of lamp and wall support.
- Lamp unit in die-cast EN-AB 47100 aluminium.
- UV resistant diffuser in shock resistant polycarbonate with satiny finish, provided with high-efficiency light-diffusing lenses.
- Wall support in painted steel.
- Painting is obtained by means of 3-stage outdoor treatment: nanotechnologies, antioxidant primer, polyester paint.
- AISI 316 stainless steel screws and silicone seal gasket.
- Provided with IP67 cable and connector for the mains connection.
- Technical features of light fixtures in compliance with EN60598-1.
- IP Rating IP65.
- ENEC approved.
- Insulation class II.

Hila floor

- Consists of lamp, support pole and ground mounting plate.
- Lamp unit in die-cast EN-AB 47100 aluminium.
- UV resistant diffuser in shock resistant polycarbonate with satiny finish, provided with high-efficiency light-diffusing lenses.
- Support pole h=90cm in extruded EN-AW-6060 aluminium, chromate treated and painted.
- Mounting plate in painted steel, with holes for ground fixing by means of log bolts or dowels.
- Painting is obtained by means of 3-stage outdoor treatment: nanotechnologies, antioxidant primer, polyester paint.
- AISI 316 stainless steel screws and silicone seal gasket.
- Provided with IP67 cable and connector for the mains connection.
- Technical features of light fixtures in compliance with EN60598-1.
- IP Rating IP65.
- ENEC approved.
- Insulation class II.



Hila floor/pole

HILA 12 W			Lighting application		
h	L	a	Em	E _{max}	E _{min}
0.9 m	1.0 m	3.2 m	50 lux	180 lux	2 lux

HALO 24W			Lighting application		
h	L	a	Em	E _{max}	E _{min}
3.5 m	3.5 m	13 m	8 lux	20 lux	2 lux

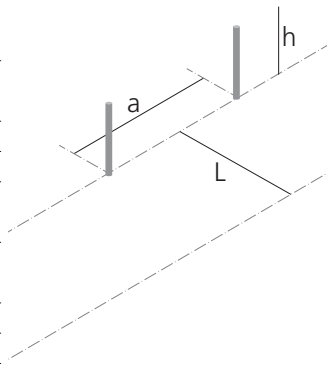

Hila

Grey-white RAL9002



Hila Pole

W	Flux	CCT	CRI	Color
24 W	1311 lm	4000 K	75	○

Code
T085900

220/240Vac 50/60Hz electronic ballast included



IP65 IK10

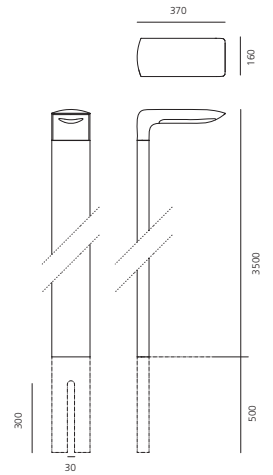

24 W 4000 K

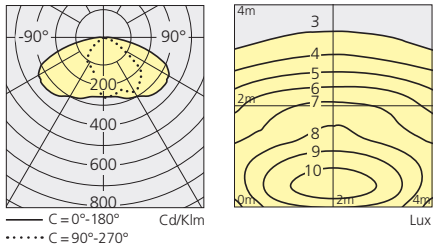

Hila Floor

W	Flux	CCT	CRI	Color
12 W	786 lm	4000 K	75	○

Code
T085700

220/240Vac 50/60Hz electronic ballast included



IP65 IK10

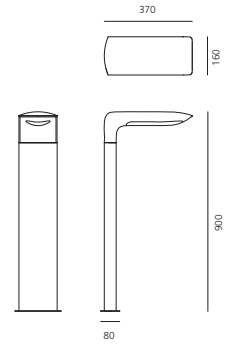

12 W 4000 K

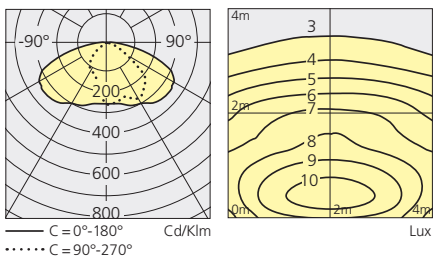

Hila Wall

W	Flux	CCT	CRI	Color
24 W	1311 lm	4000 K	75	○

Code
T085800

220/240Vac 50/60Hz electronic ballast included

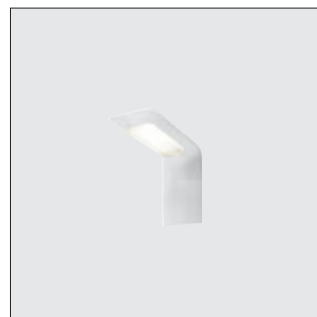

IP65 IK10

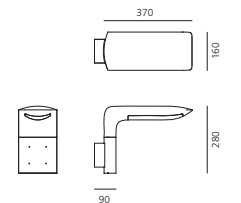

24 W 4000 K

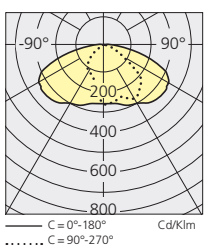

Indicta

Ernesto Gismondi
2010



-
- Light fixture with direct emission, with high-performance LED light sources.
 - $\varnothing 60$ mm pole installation with $\varnothing 35 \times 110$ mm shank (not supplied).
 - Anthracite grey finish.
 - Consists of optical housing and support for pole installation.
 - Optical housing in extruded EN-AW-6060 aluminium, chromate treated and painted with 3-stage outdoor treatment: nanotechnologies, antioxidant primer, polyester paint.
 - UV resistant diffuser in shock resistant polycarbonate.
 - High-efficiency asymmetrical optics in metalised polycarbonate.
 - Optical housing support in high-resistance mass-coloured reinforced polymers.
 - AISI 316 stainless steel screws and silicone seal gaskets.
 - Provided with IP67 cable and connector for the mains connection.
 - Technical features of light fixtures in compliance with EN60598-1.
 - IP Rating IP65.
 - ENEC approved.
 - Insulation class II.



Indicta

Anthracite grey



W	Flux	CCT	CRI	Color	Code
23 W	1341 lm	4000 K	80	●	T084800

23 W 4000 K

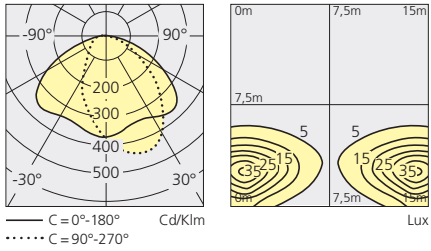

IP65

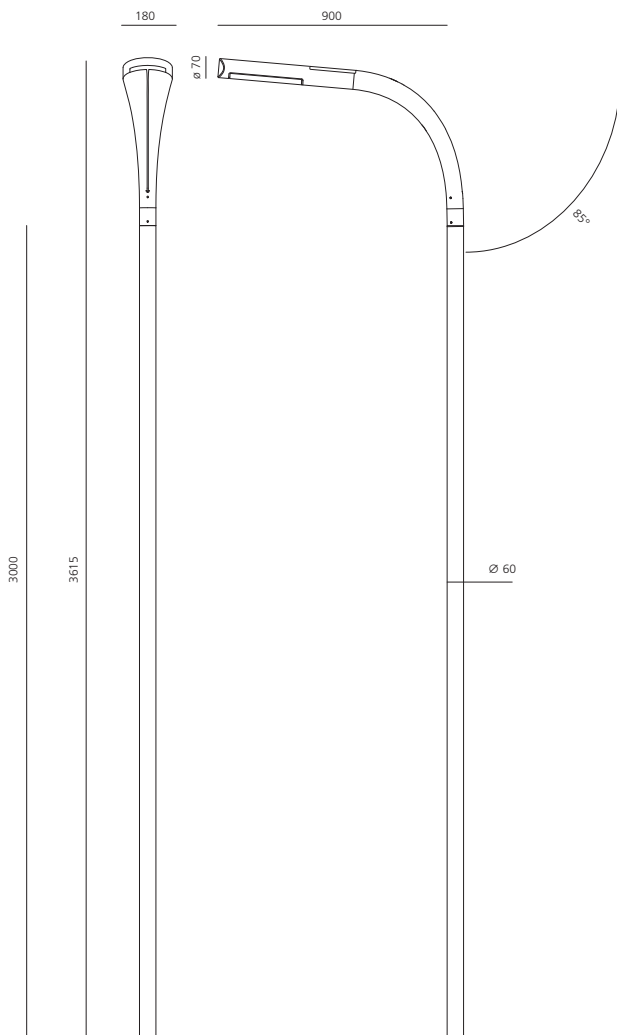
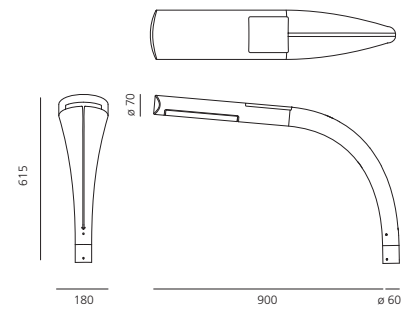

LED 23 W			Lighting application		
h	L	a	Em	Emax	Emin
3.5 m	4.0 m	13 m	12 lux	33 lux	2.8 lux

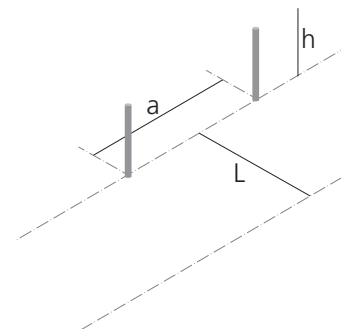



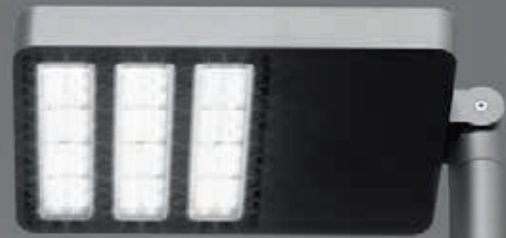

- Light fixture with direct emission, with monochromatic LED light sources.
- Pole installation (pole not supplied).
- Consists of lighting unit and 90° adjustable pole joint.
- Die-cast EN-AB 47100 aluminium lighting unit with 3-stage outdoor treatment: nanotechnologies, antioxidant primer, polyester paint.
- Asymmetrical high-efficiency PMMA optical units.
- High-transparency shock-resistant polycarbonate screens.
- Consists of 3 interchangeable optical units. AISI 316 fixing screws and silicone gaskets.
- Suitable for ME3a and ME4a road lighting.
- Technical features in compliance with EN60598-1-2-3.
- Protection level from 4KV impulse overvoltage.
- IP Rating IP66.
- ENEC approved.
- Insulation class II.

Sostituto Palo

Anthracite grey

W	Flux	CCT	CRI	Color	Code
105 W	7609 lm	4000 K	80	●	T4183ELN00

220/240Vac 50/60Hz electronic ballast included



IP65 IK10

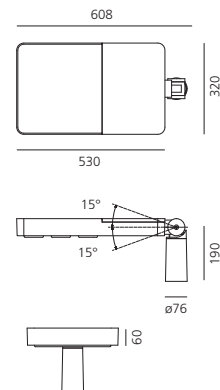

105 W 4000 K

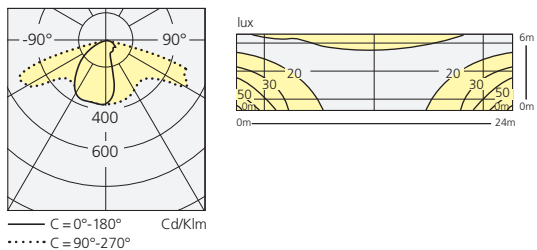

LED 105 W			Lighting application		
h	L	a	Em	E _{max}	E _{min}
6.0 m	6.0 m	24 m	23 lux	55 lux	13 lux

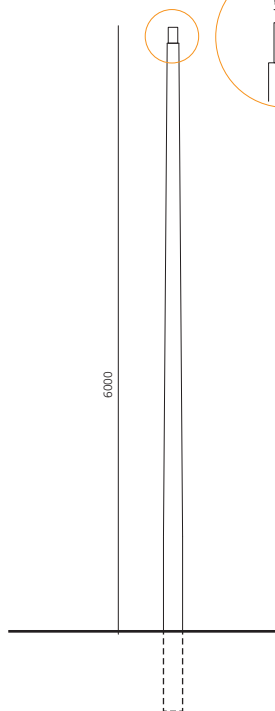
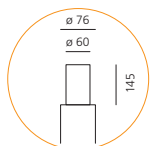
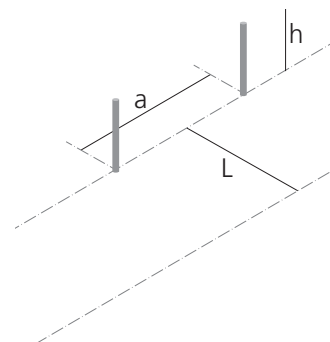
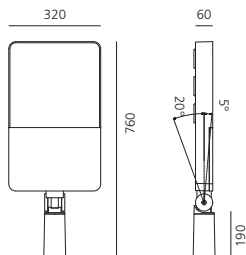

Cefiso Palo

Alessandro Pedretti
(Studio Rota & Partners)
2011



- Light fixture with adjustable direct emission, with high-performance LED light sources.
- Pole installation.
- Available in two finishes: light grey painted and anthracite grey painted.
- Consists of lighting unit and pole support. Fixing is maintained by means of locking dowels.
- The pole, not supplied, must have a \varnothing 60mm and h90mm shank to correctly fix the head- pole. The pole height must be 4m from the ground to provide a correct surface lighting. In this way, the poles can be installed at a distance of 15m, suitable to light a 4m carriageway in compliance with S3 class for cycle tracks.
- Body in EN AB44100 aluminium, pole support in galvanized iron, silicone gaskets. Electronic ballast integrated in the body.
- The light fixture is protected from impulse overvoltage up to 4KV both in differential and common mode.
- Silicone-sealed silk-screened tempered glass.
- IP67 connector for electric connection to the mains, it can be housed in the pole compartment and is suitable for cables with a diameter of 5-13.5mm.
- LED circuits with PMMA lenses with road emission beam.
- White monochromatic LEDs available in 2 colour temperatures:
Warm = 3000K
Neutral = 4000K
- Screws in AISI 316 stainless steel.
- All parts in die-cast aluminium and galvanised iron are painted with 3-stage outdoor treatment: nanotechnologies, antioxidant primer, polyester paint.
- Technical features of light fixtures in compliance with EN60598-1 and part 2-5.
- IP Rating IP65.
- Insulation class II.



Cefiso Palo

LED 40W		Lighting application			
h	L	a	Em	E _{max}	E _{min}
4.0 m	4.0 m	15 m	13 lux	27 lux	2.3 lux

Suitable for street lighting in the class S3 (bike paths).

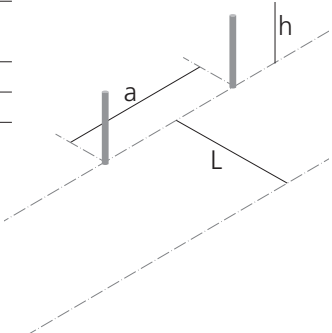

Grey-white RAL9002
○

Anthracite grey
●

W	Flux	CCT	CRI	Color	Code
40 W	1848 lm	3000 K	80	○	T418200W00
	1968 lm	4000 K	80	●	T418200W10
				○	T418200N00
				●	T418200N10

220/240Vac 50/60Hz electronic ballast included

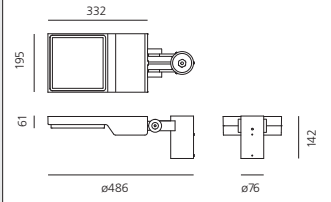

IP65 IK10

40 W 3000 K

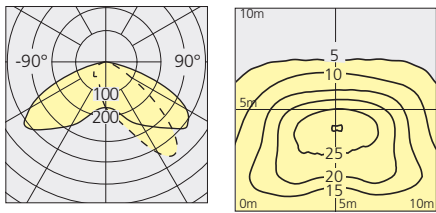

— C = 0°-180° Cd/Klm Lux
 C = 90°-270°

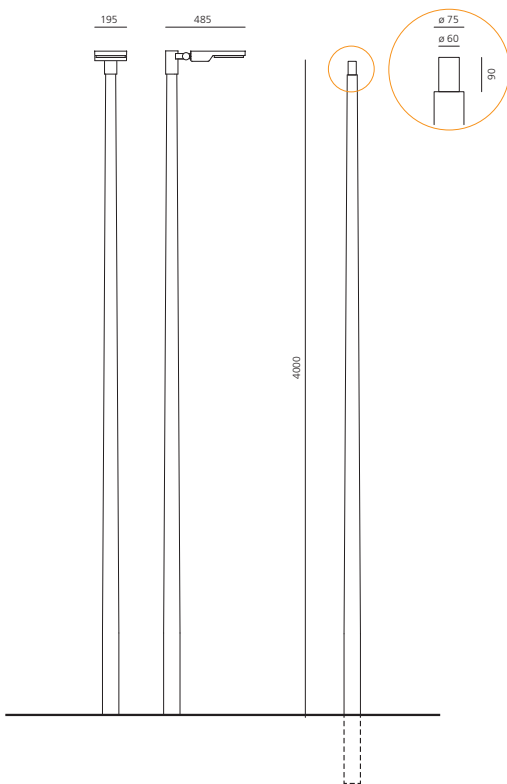



- An adjustable direct lighting appliance fitted with a high-yield LED COB source.
- Consists of a pole joint and a $-0/+90^\circ$ adjustable lighting body. Fixed into position with grub screws.
- Fixing to the pole is ensured by means of 6 grub screws.
- The pole, not included, should have a 60mm spigot to allow appropriate fixing of the pole head. The pole should be 4m high to ensure appropriate surface illumination. Under these conditions, poles can be installed 15m apart to illuminate a 4m lane, in order to ensure compliance with class S3 for cycling lanes.
- Cabling should be accommodated within the pole head, accessible through a lid, using an IP67 sealed connector fit for cables with 5 to 13.5mm diameters.
- The lighting body is powered through a H05RN-F 2x1 cable.
- Aluminium EN AB47100 head, pole joint, and sealing caps; aluminium EN AW6060 body and glass-holding ring, silicon gaskets. Electronic power unit inside the body.
- Suited for public use, protected for 4kV surges, both in the common and in the differential mode.
- Moulded silicon road lighting appliance. The tempered glass diffuser glued flush to the lighting body ensures the absence of lighting pollution.
- White monochrome LEDs available in 1 colour temperature: Neutral = 4000K
- INOX AISI 316 steel screws
- Die-cast aluminium elements painted with 3-stage outdoor treatment: nanotechnologies, anti-oxidizing primer, polyester paint.
- The technical features of the appliances comply with the EN60598-2-3 norm.
- Protection rating IP65.
- EC Certification.
- Insulation class II.

Cariddi

Anthracite grey

W	Flux	CCT	CRI	Color	Code
23 W	1730 lm	3000 K	80		T419800N00

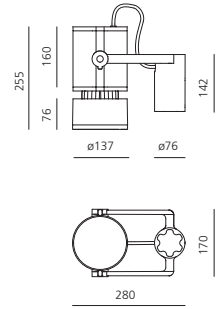

IP65 IK07

23 W 3000 K

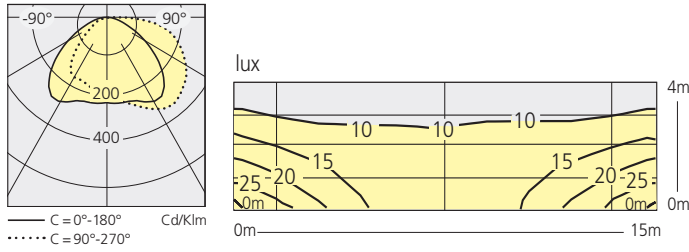

The LED circuits are directly anchored to the aluminium casing of the body in order to maximize heat dissipation. Moreover, some dissipation fins have been included in the product design to increase the heat exchange surface with external air.

The grid in the central part of the product allows natural air circulation, which cools the dissipation surface.

Due to a natural convective motion, cold air removes heat from the dissipation grid, it heats up and moves upwards, through the lighting unit, getting new fresh air from the lower part.

In this way, LEDs are maintained at a lower temperature and their life time and light efficiency increase.

Provoca wall

- Consists of lighting unit and wall support.
- Lighting unit in painted die-cast EN-AB 47100 aluminium.
- High-performance asymmetrical optics in metalised polycarbonate.
- Screens in shock resistant, high transparent tempered glass.
- Wall support in painted steel.
- Painting is obtained with 3-stage outdoor treatment: nanotechnologies, antioxidant primer, polyester paint.
- AISI 316 stainless steel screws and silicone seal gaskets.
- Technical features of light fixtures in compliance with EN60598-1.
- IP Rating IP65.
- ENEC approved.
- Insulation class I.

Provoca pole

- Head-pole fixture consists of lighting unit and pole connection.
- 50x50mm square pole installation with 40x120mm square shank (not supplied).
- Lighting unit in painted die-cast EN-AB 47100 aluminium.
- High-performance asymmetrical optics in metalised polycarbonate.
- Screens in shock resistant, high transparent tempered glass.
- Head-pole fitting in painted steel.
- Painting is obtained with 3-stage outdoor treatment: nanotechnologies, antioxidant primer, polyester paint.
- AISI 316 stainless steel screws and silicone seal gaskets.
- Technical features of light fixtures in compliance with EN60598-1.
- IP Rating IP65.
- ENEC approved.
- Insulation class I.

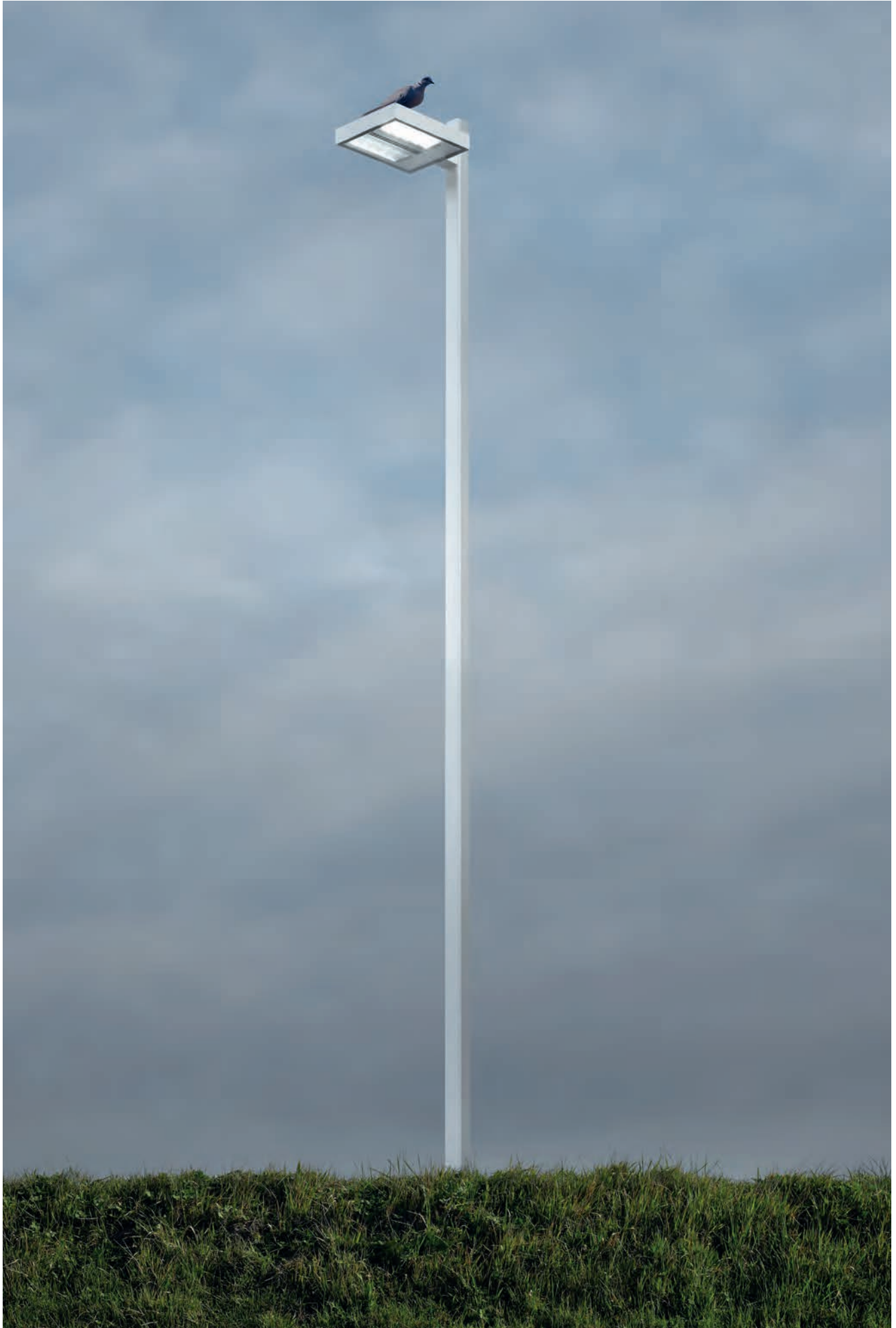

Provoca

Provoca wall

LED 23 W

Lighting application

h	L	a	Em	E _{max}	E _{min}
3.1 m	4.0 m	12 m	15 lux	48 lux	1.5 lux

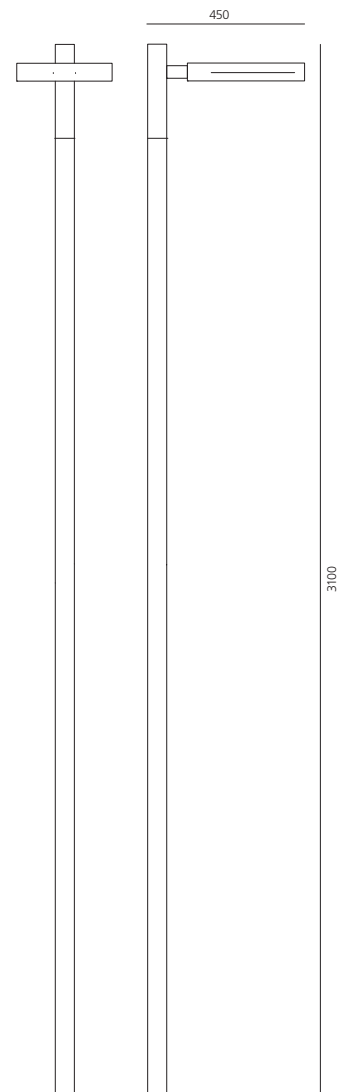
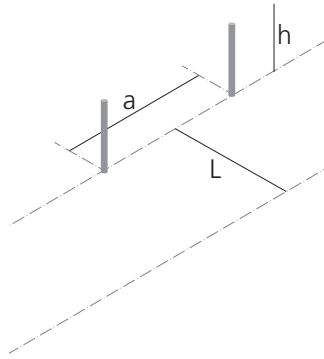

Provoca

Grey-white RAL9002
○

Provoca wall

W	Flux	CCT	CRI	Color	Code
23 W	1400 lm	4000 K	75	○	T085400

Wall support T085600

220/240Vac 50/60Hz electronic ballast included

23 W 4000 K

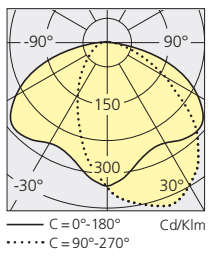

IP65 IK06

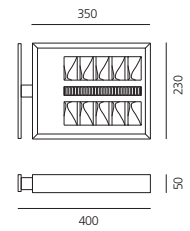

Provoca pole

W	Flux	CCT	CRI	Color	Code
23 W	1400 lm	4000 K	75	○	T085400

Pole connection T085500
pole H. 300 cm T085200

220/240Vac 50/60Hz electronic ballast included

23 W 4000 K

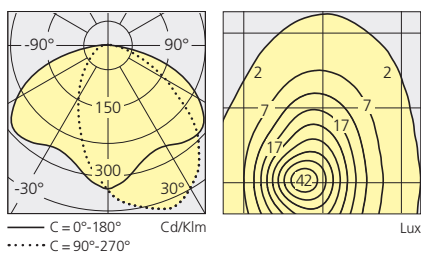

IP65 IK06

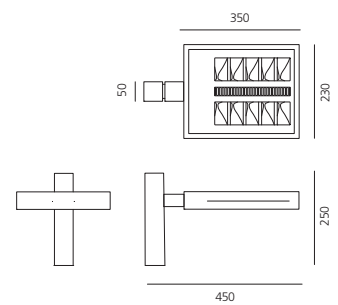

Solar Tree

Ross Lovegrove
2007



Solar Tree is conceived as a lighting appliance combining the LED-based lighting technique with the solar photovoltaic technology in a very peculiar and innovative design.

The project is aimed, on one hand, at minimizing the environmental impact of the product's use (deriving, in particular, from reduced consumption of energy obtained from fossil fuels), while ensuring that the appliance can provide service continuity and, therefore, the expected luminous performance, without being vulnerable to random weather agents or suffer design imbalance (number of panels, accumulator size) calculated for winter months. Such imbalance implies significant dimensions, weights, and costs and would not ensure continuous operation in off-average weather conditions.

The same logical principles implemented in the automotive sector on electric cars, with hybrid versions taking the lead over pure electric battery-based ones for a number of reasons, such as costs, performance, and state of the art of certain technologies, were used to develop the Solar Tree project by Artemide. With its mixed accumulator/solar and network configuration, it provides the best possible energy saving and functionality combination.



Solar Tree

- The structure consists of curved steel poles of different diameters and heights, reaching a maximum total 5.5m height above road level. The system includes 10 "grass blades" with 3mm-thick poles with a 40mm diameter, fitted with 1 1W terminal LED protected by a PMMA diffuser screen, and 10 4mm-thick poles with a 76mm diameter supporting the PETG heads with the solar panels. Emission is diffused.
- The poles are coated with pale green outdoor epoxy paint fading to white, and finished with a transparent layer.
- Four of the ten heads (all with photovoltaic cells on the top) are fitted with a LED unit (20 LEDs with a neutral white colour temperature, powered with up to 500mA) at the bottom for direct downward emission, sealed with a plastic screen to ensure protection from water and dust.
- The base is made of hot-zinc coated sheet steel designed for enclosure in a plinth of the appropriate size, not provided with the appliance, to be sunk into the ground. Alternatively a base is available, also made of zinc-coated steel with reinforced concrete stabilizing units forming a round seat. In this case the base can simply rest on the ground, even if ground fixing is always recommended.
- The connection/cablings elements, as well as the control and charging boards, are contained in multiple water-tight boxes with plug-and-socket connectors with protection rating IP65 or higher, and located either in appropriate spots at the foot of the base for easy inspection and maintenance, or inside the concrete stabilizing unit, as specified in detail for the Solar Tree version constituting the object of the supply.
- The airtight accumulators are contained in specific boxes that allow, on one hand, to protect the battery mechanically and from outer agents and, on the other to release any gas discharges, to be provided for by the law.



Configuration

The light fitting configuration includes an analysis of the potential incoming energy (geographical location of the light fitting) and a detailed analysis of the physical location of the light fitting (proximity of buildings or trees). Lastly, an analysis of the level of requested service and performance will be implemented (luminance levels, operation hours, potential discontinuity in the service, if any).

Technical data

- Total number of heads with solar panels: 10
- Number of heads with LEDs: 4
- Installed power for each light head: about 23.1 W at 350mA (base current drive), max current drive 500mA.
- 20 power LEDs for each head in neutral light tonality 4300K.
- Maximum luminous flux for each head: minimum 1250 Lm.
- Solar panel voltage in open circuit: about 10 V.
- Peak power for each panel: about 63 W.
- Total number of "stems": 10.
- LED power for each "stem": about 1 W with a power supply of 350mA.
- 2 Batteries
- Battery voltage: 12 V
- Single battery capacity: 240 Ah
- Box with USB connection for diagnostics/ setting/servicing access.
- Technical features of the light fixture in compliance with EN60598-1.
- IP Rating IP65.
- Insulation class II.

$$E_{in} = \sum P_{\text{peak power}} \cdot h_{\text{equivalent}} \cdot \eta_{\text{system}} \cdot \eta_{\text{noct}} \cdot \eta_{\text{tilt angle}}$$

$P_{\text{peak power}}$ = Maximum power input

$h_{\text{equivalent}}$ = Average received solar radiation in hours

η_{system} = System conversion efficiency

η_{noct} = Nominal operating temperature

$\eta_{\text{tilt angle}}$ = Exposure factor

Solar Tree

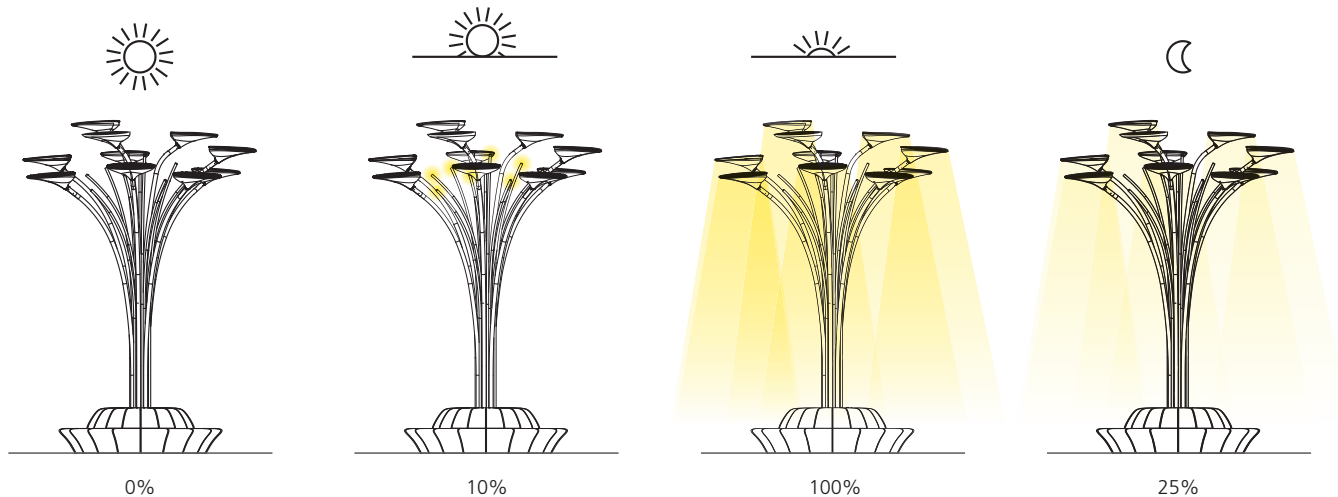

Working

Solar Tree was designed for operation in the HYBRID configuration: in addition to the batteries, generally of the appropriate capacity to contain energy for autonomous operation for up to 7-10 days (with an energy-saving operation cycle, better specified below) with full charge, connection with the mains is provided for energy supply to the appliances (via an appropriate DC power unit connected with the mains) when the batteries are depleted. This is to ensure full service availability even in case of persistent bad weather and/or reduced sun irradiation or 100% use of the luminous performance of the appliance, or anyway when the energy balance is negative.

At dusk (recognized by determination of the dawn and sunset time entered into the calculation routine of the management programme or otherwise), the LED sources are turned on until dawn according to the pre-set duty-cycle.

In "HYBRID" appliances, the system draws energy from the batteries until these fall to the lower charge limit, then switches automatically to the mains.

For appliances based on this configuration, if mains connections coincided with the desired switching time of the public lighting appliances to which the Solar Tree functionally refers, appropriate settings would ensure that the voltage available upon powering is interpreted as a start signal for the Solar Tree, and vice versa in case of disconnection from the mains.

Working programs

Two operating modes are available to satisfy individual needs – Manual and Automatic. The Automatic mode can, in turn, be configured in three different ways, according to the desired performance and energy saving attitude. More specifically: AUTO ECO: 100% operation at times of maximum attendance of the venue, limited operation of the LED heads only in the middle of the night (to ensure average 8 lux ground illumination, the LED sources are turned on and adjusted to approximately 25% of their nominal operating power from sunset to dawn. This mode is recommended to tend to full operation coverage even during the fall/winter in view of energy balance).

AUTO 100%: an operation mode that tends to ensure maximum operating performance of the appliance adjusting to the increased input of solar energy (if any).

CUSTOMIZED: the user can select the desired operating times and profiles.

The above-described profiles can be associated with deadlines and, therefore, be selected alternatively.

MANUAL: can be enabled by the user in case of special events and/or needs. The user can access the "fine" adjustment menu for selection on a 0-100% scale of the flow emitted by the individual LED heads and by the bunch of stems. The sources then remain switched on and adjusted according to the user's settings until switching off or returning to the automatic mode under the user's control.

4 photovoltaic cells with 20 LEDs each

10 "stems" 1 LED each

6 photovoltaic cells +
dissipators



Solar Tree

LED

W	CRI	Flux	CCT
4 heads LED	23 W (92 W Tot.)	1932 lm (7728 lm Tot.)	4300 K
+ 10 stems LED	1 W (10 W Tot.)		6000 K

Lighting units, curved poles, "stems" and batteries
 Pole support structure + 18 benches

Code

T080600
 T080400

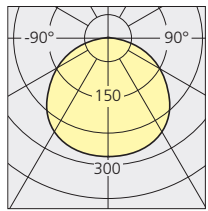

— C = 0°-180° Cd/Klm
 C = 90°-270°

Light intensity of one head.
 Flow 1250 lm

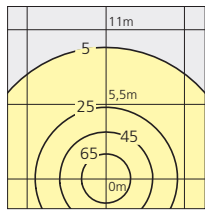

Lighting of the whole fixture.

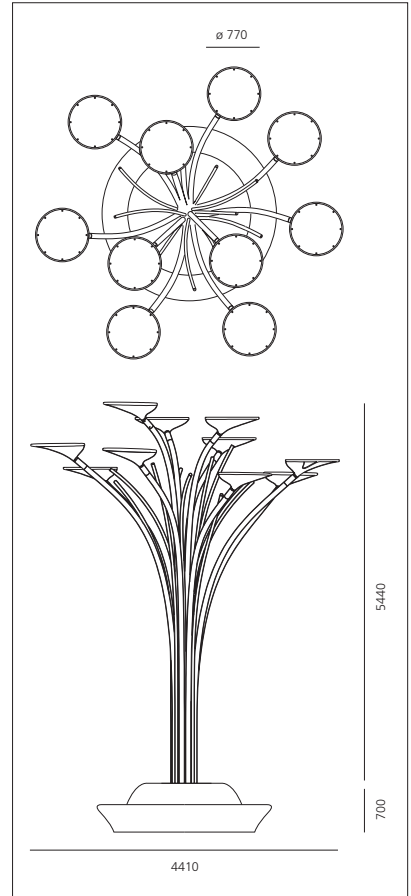

⊕ IP65 power box and pole heads
 IP44 battery compartment

A.

Technical Data

How to read the catalogue

Product table

POWER OF DEVICE	WEIGHT OF DEVICE	LUMINOUS BEAM OPENING	DEVICE LUMINOUS FLUX	LIGHT COLOR TEMPERATURE	DEVICE COLOR	PRODUCT CODE VERSION A	VAT EXCLUDED PRICES	PRODUCT CODE VERSION B	PRODUCT PHOTO IP DEGREE OF PROTECTION APPROVALS ORIENTATION AND ROTATION VALUES SILHOUETTE
-----------------	------------------	-----------------------	----------------------	-------------------------	--------------	------------------------	---------------------	------------------------	--

LED						non dimmable*	Dali-SwitchDim**
W	Weight	Beam	Flux	CCT	Color	Code	Code
36 W	1,30 kg	2x8°	2768 lm	3000 K	○	M141420	M141421
					●	M141410	M141411
					◐	M141480	M141481
			2962 lm	4000 K	●	M141450	M141451
					○	M141620	M141621
					●	M141610	M141611
		2x18°	2452 lm	3000 K	◐	M141680	M141681
					●	M141650	M141651
					○	M141520	M141521
			2623 lm	4000 K	●	M141510	M141511
					◐	M141580	M141581
					○	M141550	M141551
				○	M141720	M141721	
				●	M141710	M141711	
				◐	M141780	M141781	
					●	M141750	M141751



IP20 □ 850°

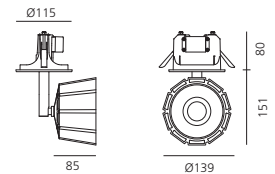

Luminous data table

PRODUCT NAME AND SPECIFIC SOURCE	LIGHT SOURCE DATA	LIGHT SOURCE DATA OUTPUT BY THE DEVICE	POLAR CURVE AND DEVICE W	LIGHT CONE LIGHT COLOUR TEMPERATURE AND LIGHT BEAM OPENING
----------------------------------	-------------------	--	--------------------------	--

Airlite 2x8°	LED	luminaire	36 W	3000 K	α=2x8°
Power	31 W	31 W	36 W	36 W	
Flux	3454 lm	3695 lm	2768 lm	2962 lm	
CCT	3000 K	4000 K	3000 K	4000 K	
CRI	=80 (min.)				
Color tolerance	MacAdam 3SDCM				
Service life	L70(6K)>36000h				
Beam			2x8°	2x8°	
Efficiency			80%	80%	
Efficacy	111 lm/W	119 lm/W	76 lm/W	81 lm/W	

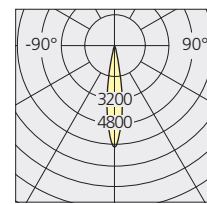

H m	Ø m	E _{Max} lux	E _M lux
0,5	0,15	66306	32115
1,0	0,30	16576	8029
1,5	0,45	7367	3568
2,0	0,60	4144	2007
2,5	0,75	2652	1285
3,0	0,90	1842	892

IN A SPOTLIGHT OR, MORE GENERALLY, IN A DEVICE WITH ROTATIONAL OR X-Y TYPE SYMMETRY, DOUBLE THE ANGLE BETWEEN THE DIRECTION OF AXIAL LIGHT INTENSITY AND THE DIRECTION WHERE THE INTENSITY EQUALS ½ THE AXIAL INTENSITY. THE HUMAN EYE PERCEIVES THE LIGHTING VALUES IN THIS CONE AS CONSTANTS.

LIGHTING DEVICE EFFICIENCY
RATIO BETWEEN THE INSTALLED FLOW AND THE ABSORBED POWER MEASURED AT THE PLUG (WHICH THEREFORE INCLUDES POWER SUPPLY LOSSES). MEASURED IN LM/W.

LIGHTING DEVICE EFFICACY
RATIO, EXPRESSED IN %, BETWEEN THE INSTALLED FLOW AND THE OUTPUT FLOW.

Key

Classifications



Class I

Device in which electrical safety is provided by an additional protective conductor (earth) connected to the metal frame of the lamp.



Class II

Device in which protection against electric shocks is not provided solely by the basic insulation, but which has additional safety measures such as double or reinforced insulation.

These measures do not involve earthing devices and do not depend on the installation conditions.



Class III

Device in which protection against electric shocks is based on a safety extra-low voltage power source and in which no voltages greater than this can be generated.

A class III device does not need earth protection.

Approvals



ENEC certification of European conformity.

Feeding tension

LV

Low Voltage

Components (electrified plates, optional extensions, cables and feeding kits) with 3-wire cables (+, -, signal) and 48VDC feeding tension. Feeding unit and control interfaces are needed in addition. Generally used for RGB LEDs, with the exception of Stand Alone versions.

MV

Medium Voltage

Components (electrified plates, optional extensions, cables and feeding kits) with 7-wire cables (Neutral, Direct Line, Indirect Line, Auxiliary Line, Earth, DALI 1 and DALI 2) and 230 VAC feeding tension. If dimming is required, an external DALI circuit complete with DALI power supply, group controller and scene controller is needed. Used for feeding and dimming fluorescent lamps, white LEDs, spot groups and RGB Stand Alone LED versions.

Rates

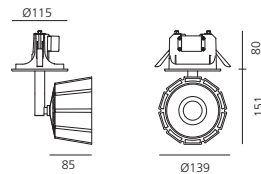

The diagrams shown in this catalogue are expressed in millimetres.

IP degree of protection

Electrical fittings are designed to prevent the intrusion and contact of solids and liquids with live parts.

Resistance to the penetration of solids and liquids is expressed by the acronym IP, followed by two digits that show the degree of protection: the first digit refers to solid bodies, the second to liquids.

First digit

- 0 No protection.
- 1 Protected against the penetration of solid bodies larger than 50 mm.
- 2 Protected against the penetration of solid bodies larger than 12 mm.
- 3 Protected against the penetration of solid bodies larger than 2.5 mm.
- 4 Protected against the penetration of solid bodies larger than 1 mm.
- 5 Protected against dust.
- 6 Totally dust-tight.

Second digit

- 0 No protection.
- 1 Protected against dripping water.
- 2 Protected against dripping water up to 15° from the vertical.
- 3 Protected against rain.
- 4 Protected against splashing water.
- 5 Protected against water jets.
- 6 Protected against waves.
- 7 Water-tight on immersion.
- 8 Water-tight on submersion.

Photometric data

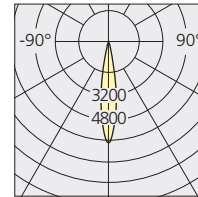

Photometric curve in polar coordinates

This represents the distribution of light intensity (expressed in candelas/1000 lumen) emitted by the device on the planes passing through the optical axis of the device. Two curves are indicated for each device, one relating to the transversal plane C0 - C180 (continuous line) and the other to the longitudinal plane C90 - C270 (dotted line). The photometric curve defines the lighting technology properties of the device, such as luminous flux control, the type of emission and the direction of maximum intensity. These are required for verification of the illumination values during application. The photometric curves shown in this catalogue are only provided as guidelines. The Dialux calculation programme should be used for accurate photometric data.

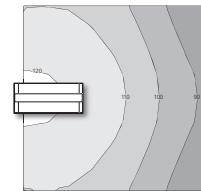

Isolux curve

This is a graphical representation of the distribution of illumination values on the horizontal plane (floor lamps). The isolux lines connect points of equal illumination values.

H m	Ø m	EMax lux	EM lux
0,5	0,15	66306	32115
1,0	0,30	16576	8029
1,5	0,45	7367	3568
2,0	0,60	4144	2007
2,5	0,75	2652	1285
3,0	0,90	1842	892

Light cone

This indicates the maximum illumination level expressed in lux measured in horizontal portions at different heights with respect to the device. ØC0 and ØC90 represent the lengths of the axes of the sections. The two values will be the same when the emissions are rotationally symmetric. The angle of emission indicates the plane angle subtended by the directions in which the luminous intensity is 50% of the maximum intensity.

Linear fluorescent lamps

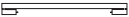
	LBS	ILCOS L	W	Beam	T color	Socket	Flux	CRI	Specs	Code
	T16-SEAMLESS	FDH-28	28W	-	3000K	G5	2600lm	85	HE-FH	M004810
	T16-SEAMLESS	FDH-28	28W	-	4000K	G5	2600lm	85	HE-FH	M004815
	T16-SEAMLESS	FDH-54	54W	-	3000K	G5	4450lm	85	HO-FQ	M004800
	T16-SEAMLESS	FDH-54	54W	-	4000K	G5	4450lm	85	HO-FQ	M004805

	LBS	ILCOS L	W	Beam	T color	Socket	Flux	CRI	Specs	Code
	T16	FDH-14	14W	-	3000K	G5	1200lm	85	HE-FH	M004300
	T16	FDH-14	14W	-	4000K	G5	1200lm	85	HE-FH	M004305
	T16	FDH-21	21W	-	3000K	G5	1900lm	85	HE-FH	M004340
	T16	FDH-24	24W	-	3000K	G5	1750lm	85	HO-FQ	M004370
	T16	FDH-24	24W	-	4000K	G5	1750lm	85	HO-FQ	M004371
	T16	FDH-28	28W	-	3000K	G5	2600lm	85	HE-FH	M004280
	T16	FDH-28	28W	-	4000K	G5	2600lm	85	HE-FH	M004325
	T16	FDH-35	35W	-	3000K	G5	3300lm	85	HE-FH	M004290
	T16	FDH-35	35W	-	4000K	G5	3300lm	85	HE-FH	M004295
	T16	FDH-39	39W	-	3000K	G5	3100lm	85	HO-FQ	M004380
	T16	FDH-39	39W	-	4000K	G5	3100lm	85	HO-FQ	M004381
	T16	FDH-54	54W	-	3000K	G5	4450lm	85	HO-FQ	M004350
	T16	FDH-54	54W	-	4000K	G5	4450lm	85	HO-FQ	M004355
	T16	FDH-80	80W	-	3000K	G5	6150lm	85	HO-FQ	M004360
	T16	FDH-80	80W	-	4000K	G5	6150lm	85	HO-FQ	M004365

Compact fluorescent lamps

	LBS	ILCOS L	W	Beam	T color	Socket	Flux	CRI	Code
	TC-DEL	FSQ-13	13W	-	3000K	G24q-1	900lm	85	M004630
	TC-DEL	FSQ-18	18W	-	3000K	G24q-2	1200lm	85	M004188
	TC-DEL	FSQ-26	26W	-	3000K	G24q-3	1800lm	85	M004181

	LBS	ILCOS L	W	Beam	T color	Socket	Flux	CRI	Code
	TC-TEL	FSM-14	14W	-	3000K	GR14q-1	1200lm	85	M004035
	TC-TEL	FSM-17	17W	-	3000K	GR14q-1	1500lm	85	M004031

	LBS	ILCOS L	W	Beam	T color	Socket	Flux	CRI	Code
	TC-LEL	FSD-18	18W	-	3000K	2G11	1200lm	85	M004140
	TC-LEL	FSD-36	36W	-	3000K	2G11	2900lm	85	M004190
	TC-LEL	FSDH-55	55W	-	3000K	2G11	4800lm	85	M004400
	TC-LEL	FSDH-80	80W	-	3000K	2G11	6500lm	85	M004660

	LBS	ILCOS L	W	Beam	T color	Socket	Flux	CRI	Code
	TC-TEL	FSM-18	18W	-	3000K	GX24q-2	1200lm	85	M004570
	TC-TEL	FSMH-32	32W	-	3000K	GX24q-3	2400lm	85	M004420
	TC-TEL	FSMH-42	42W	-	3000K	GX24q-4	3200lm	85	M004410

	LBS	ILCOS L	W	Beam	T color	Socket	Flux	CRI	Code
	TC-FEL	FSD-36	36W	-	3000K	2G10	2800lm	85	M004060

	LBS	ILCOS L	W	Beam	T color	Socket	Flux	CRI	Code
	T16-R	FSCH-22	22W	-	3000K	2GX13	1800lm	85	M004500

Beam	T color	Socket	Flux	Code
-	3500K	GR10q3	3900lm	M004230

Metal iodide lamps

	LBS	ILCOS L	W	Beam	T color	Socket	Flux	CRI	Code
	HIT-TC-CE	MT/UB-20	20W	-	3000K	GU6,5	1600lm	80-85	M004835
	HIT-TC-CE	MT/UB-20	35W	-	3000K	GU6,5	3400lm	80-85	M004830

	LBS	ILCOS L	W	Beam	T color	Socket	Flux	CRI	Code
	HIT-TC-CE	MT/UB-20	20W	-	3000K	G8,5	1700lm	80-85	M003080
	HIT-TC-CE	MT/UB-35	35W	-	3000K	G8,5	3400lm	80-85	M003030
	HIT-TC-CE	MT/UB-70	70W	-	3000K	G8,5	6600lm	80-85	M003090

	LBS	ILCOS L	W	Beam	T color	Socket	Flux	CRI	Code
	HIT-CE	MT/UB-35	35W	-	3000K	G12	3300lm	85	M003165
	HIT-CE	MT/UB-70	70W	-	3000K	G12	6600lm	85	M003150
	HIT-CE	MT/UB-70	70W	-	4200K	G12	6600lm	85	M003155
	HIT-CE	MT/UB-150	150W	-	3000K	G12	14000lm	85	M003160

	LBS	ILCOS L	W	Beam	T color	Socket	Flux	CRI	Code
	HIPAR51-CE-P	MRS/UB-20	20W	10°	3000K	GX10	-	80-85	M003320
	HIPAR51-CE-P	MRS/UB-20	20W	25°	3000K	GX10	-	80-85	M003330
	HIPAR51-CE-P	MRS/UB-20	20W	40°	3000K	GX10	-	80-85	M003340
	HIPAR51-CE-P	MRS/UB-35	35W	12°	3000K	GX10	-	80-85	M003275
	HIPAR51-CE-P	MRS/UB-35	35W	25°	3000K	GX10	-	80-85	M003280
	HIPAR51-CE-P	MRS/UB-35	35W	40°	3000K	GX10	-	80-85	M003290

H	Ø	EMax	EM	H	Ø	EMax	EM	H	Ø	EMax	EM	H	Ø	EMax	EM	H	Ø	EMax	EM				
m	m	lux	lux	m	m	lux	lux	m	m	lux	lux	m	m	lux	lux	m	m	lux	lux				
1	0,15	36401	18265	1	0,17	55197	27849	1	0,37	8385	4009	1	0,41	13953	6578	1	0,69	4450	1887	1	0,62	8300	3613
2	0,30	9100	4566	2	0,34	13799	6962	2	0,75	2096	1002	2	0,83	3488	1644	2	1,38	1113	472	2	1,25	2075	903
3	0,45	4045	2029	3	0,50	6133	3094	3	1,12	932	445	3	1,24	1550	731	3	2,07	494	210	3	1,87	922	401
4	0,60	2275	1142	4	0,67	3450	1741	4	1,50	524	251	4	1,66	872	411	4	2,75	278	118	4	2,49	519	226
HIPAR51-CE-P 20W 12°				HIPAR51-CE-P 35W 15°				HIPAR51-CE-P 20W 25°				HIPAR51-CE-P 35W 25°				HIPAR51-CE-P 20W 40°				HIPAR51-CE-P 35W 40°			

	LBS	ILCOS L	W	Beam	T color	Socket	Flux	CRI	Code
	HIT-DE-CE-h45	MD/UB-70	70W	-	3000K	RX7s	6300lm	80-85	M003260
	HIT-DE-CE-h45	MD/UB-150	150W	-	3000K	RX7s	13500lm	80-85	M003270
					3000K	Fc2	20000lm	M003020	

	LBS	ILCOS L	W	Beam	T color	Socket	Flux	CRI	Code
	HIR111-CE-P	MRS/UB-35	35W	10°	3000K	GX8,5	-	80-85	M003310
	HIR111-CE-P	MRS/UB-35	35W	24°	3000K	GX8,5	-	80-85	M003170
	HIR111-CE-P	MRS/UB-35	35W	40°	3000K	GX8,5	-	80-85	M003190
	HIR111-CE-P	MRS/UB-70	70W	10°	2900K	GX8,5	-	80-85	M003185
	HIR111-CE-P	MRS/UB-70	70W	24°	2900K	GX8,5	-	80-85	M003175
	HIR111-CE-P	MRS/UB-70	70W	40°	3000K	GX8,5	-	80-85	M003178

H	Ø	EMax	EM	H	Ø	EMax	EM	H	Ø	EMax	EM	H	Ø	EMax	EM	H	Ø	EMax	EM				
m	m	lux	lux	m	m	lux	lux	m	m	lux	lux	m	m	lux	lux	m	m	lux	lux				
1	0,15	36401	18265	1	0,37	8385	4009	1	0,69	4450	1887	1	0,17	55197	27849	1	0,62	8300	3613				
2	0,30	9100	4566	2	0,75	2096	1002	2	1,38	1113	472	2	0,34	13799	6962	2	0,83	3488	1644				
3	0,45	4045	2029	3	1,12	932	445	3	2,07	494	210	3	0,50	6133	3094	3	1,24	1550	731				
4	0,60	2275	1142	4	1,50	524	251	4	2,75	278	118	4	0,67	3450	1741	4	1,66	872	411				
HIR111-CE-P 35W 10°				HIR111-CE-P 35W 24°				HIR111-CE-P 35W 40°				HIR111-CE-P 70W 10°				HIR111-CE-P 70W 24°				HIR111-CE-P 70W 40°			

230-240V LED lamps

				Beam	T color	Socket	Flux		Code
	-	-	4W	25°	3000K	GU10	-	85	M004720
	H m	Ø m	EMax lux	EM lux					
	1	0,39	550	247					
	2	0,78	137	61					
	3	1,17	61	27					
	4	1,56	34	15					
	TCR35-SE 3W			25°					

	LBS	ILCOS L	W	Beam	T color	Socket	Flux	CRI	Code			
	-	-	8W	25°	3000K	GU10	-	85	M004760			
	-	-	8W	40°	3000K	GU10	-	85	M004770			
	-	-	8W	25°	4000K	GU10	-	85	M004765			
	-	-	8W	40°	4000K	GU10	-	85	M004775			
	H m	Ø m	EMax lux	EM lux	H m	Ø m	EMax lux	EM lux	H m	Ø m	EMax lux	EM lux
	1	0,43	1006	474	1	0,71	402	168	1	0,40	1148	547
	2	0,85	252	118	2	1,42	100	42	2	0,79	287	137
	3	1,28	112	53	3	2,14	45	19	3	1,19	128	61
	4	1,70	63	30	4	2,85	25	11	4	1,58	72	34
	TCR50-SE 7W 3000K 25°			TCR50-SE 7W 3000K 40°			TCR50-SE 7W 4200K 25°			TCR50-SE 7W 4200K 40°		

	LBS	ILCOS L	W	Beam	T color	Socket	Flux	CRI
	MR16	-	5W	24°-36°	2700K	G5,3	-	80
	MR16	-	5W	24°-36°	3000K	G5,3	-	80
	MR16	-	7W	24°-36°	2700K	G5,3	-	80
	MR16	-	7W	24°-36°	3000K	G5,3	-	80
	MR16	-	7W	24°-36°	4000K	G5,3	-	80
	MR16	-	11W	24°-36°	2700K	G5,3	-	80
	MR16	-	11W	24°-36°	3000K	G5,3	-	80
	MR16	-	11W	24°-36°	4000K	G5,3	-	80

	LBS	ILCOS L	W	Beam	T color	Socket	Flux	CRI
	AR111	-	12W	40°	3000K	GU53	-	80
	AR111	-	12W	40°	4000K	GU53	-	80

12V halogen lamps



LBS	ILCOS L	W	Beam	T color	Socket	Flux	CRI	Code								
QR-CBC51	HRGS/UBIB	35W ECO	10°	3000K	GU5,3	-	100	M001155								
QR-CBC51	HRGS/UBIB	35W ECO	24°	3000K	GU5,3	-	100	M001160								
QR-CBC51	HRGS/UBIB	35W ECO	36°	3000K	GU5,3	-	100	M001165								
QR-CBC51	HRGS/UBIB	35W ECO	60°	3000K	GU5,3	-	100	M001170								
QR-CBC51	HRGS/UB	50W	10°	3000K	GU5,3	-	100	M001020								
QR-CBC51	HRGS/UB	50W	24°	3000K	GU5,3	-	100	M001220								
QR-CBC51	HRGS/UB	50W	36°	3000K	GU5,3	-	100	M001010								
QR-CBC51	HRGS/UB	50W	60°	3000K	GU5,3	-	100	M001300								
H m	Ø m	EMax lux	EM lux	H m	Ø m	EMax lux	EM lux	H m	Ø m	EMax lux	EM lux	H m	Ø m	EMax lux	EM lux	
1	0,17	14750	7364	1	0,36	5250	2505	1	0,66	2300	988	1	1,07	1110	381	
2	0,34	3688	1841	2	0,73	1313	626	2	1,32	575	247	2	2,14	278	95	
3	0,50	1639	818	3	1,09	583	278	3	1,97	256	110	3	3,22	123	42	
4	0,67	922	460	4	1,45	328	157	4	2,63	144	62	4	4,29	69	24	
QR-CBC51 50W		10°	QR-CBC51 50W	24°	QR-CBC51 50W	36°	QR-CBC51 50W	60°								



LBS	ILCOS L	W	Beam	T color	Socket	Flux	CRI	Code								
QR111	HMGS/UBIB	35W ECO	6°	3000K	G53	-	100	M001175								
QR111	HMGS/UBIB	35W ECO	24°	3000K	G53	-	100	M001180								
QR111	HMGS/UBIB	50W ECO	6°	3000K	G53	-	100	M001185								
QR111	HMGS/UBIB	50W ECO	24°	3000K	G53	-	100	M001195								
QR111	HMGS/UB	50W	6°	3000K	G53	-	100	M001330								
QR111	HMGS/UB	50W	24°	3000K	G53	-	100	M001340								
QR111	HMGS/UBIB	65W ECO	6°	3000K	G53	-	100	M001310								
QR111	HMGS/UBIB	65W ECO	24°	3000K	G53	-	100	M001395								
QR111	HMGS/UB	75W	6°	3000K	G53	-	100	M001365								
QR111	HMGS/UB	75W	24°	3000K	G53	-	100	M001360								
QR111	HMGS/UB	100W	6°	3000K	G53	-	100	M001370								
QR111	HMGS/UB	100W	24°	3000K	G53	-	100	M001390								
H m	Ø m	EMax lux	EM lux	H m	Ø m	EMax lux	EM lux	H m	Ø m	EMax lux	EM lux	H m	Ø m	EMax lux	EM lux	
1	0,12	23091	11634	1	0,13	29992	15195	1	0,12	48000	23900	1	0,40	8500	4044	
2	0,24	5773	2908	2	0,25	7498	3799	2	0,24	12000	5975	2	0,80	1002	482	
3	0,37	2566	1293	3	0,38	3332	1688	3	0,36	5333	2656	3	1,22	589	278	
4	0,49	1443	727	4	0,50	1874	950	4	0,48	3000	1494	4	1,60	250	121	
4	1,63	331	157	4	1,58	531	253									
QR111 50W		6°	QR111 75W	6°	QR111 100W	6°	QR111 50W	6°	QR111 75W	6°	QR111 100W	6°				

Characteristics of LED and components

Artemide always develops its products with special attention to the flexibility of using all possible innovations in the field of LEDs. Many are, in fact, a variety of components available on the market, each with its own special features and suitable for different purposes.

Artemide designs and manufactures all the LED circuits required to turn on the product and operate it correctly over time, in order to prevent any problems and quickly repair any possible defects.

Among the most important types of LED used are:

- 5mm LED, which offers the highest average life span with intermediate light levels;
- SMD-LED, which enables the size to be minimised while maintaining good values of luminous flux;
- Power LED, characterised by a wide choice of power and luminous flux and high life expectancy;
- multi-chip LED, characterised by high power, up to over 20W per module, with high luminous flux.

Artemide offers the possibility of using dimmable systems (1-10V, PUSH button, DALI) or home automation control and lighting management systems by means of specific drivers or ad-hoc solutions. The dimming of the LED allows you to create user-controlled lighting scenarios and adjust the brightness for better viewing comfort.

Artemide is able to customise and tailor their products to meet the various design requirements, thanks to the electronic control and the flexibility in the choice of LED. To request any type of specific or special project, you can contact our technical department.

Artemide manufactures its circuits with power signals in constant current or constant voltage, equivalent to a connection in series or in parallel to the products, respectively. For the correct selection of the transformer or power supply required to operate the lighting, we recommend you follow these guidelines:

Power calculation for transformers:

To properly select the transformer necessary for electrical installation, it is sufficient to sum up the power values of each fixture, expressed in VA (Volt Ampere), as indicated in the catalogue, and to select a transformer with a rated power 20% higher than the resulting total power value.

7 x Label Light 125 - 28Vac

$7 \times 23VA = 161VA + 20\% = 193,20VA \rightarrow$ Trasform. NL87770

Power calculation for electronic driver with constant current:

To properly select the driver necessary for electrical installation, it is sufficient to sum up the power values of each fixture, expressed in W (Watt), as indicated in the catalogue, and to select a ballast with a rated power 20% higher than the resulting total power value.

7 x Linea LED 8W - 24Vdc

$7 \times 8W = 56W + 20\% = 67,2W \rightarrow$ Power supply NL8711

Power calculation for electronic driver with constant current

To properly select the driver with constant current (350/500/700mA), choose the driver following the indication "N° LED max" in the relevant driver table.

3 x Zeno Up 3 - 500mA

$3 \times 3 = 9 \text{ LED} \times 2W \rightarrow$ Power supply NL19034

Drivers

Constant current driver for series connection (indoor use)

Code	Description	V (Vac)	I (mA)	P (W)	N°Led max	L (mm)	W (mm)	H (mm)	
NL19041	Driver 8W 500mA SLIM	220-240	500	8	4	22	110	19	indip. use
NL19036	Driver 20W 700mA	220-240	700	20	2-7	125	38	23	indip. use

Constant current driver for series connection (outdoor use)

Code	Description	V (Vac)	I (mA)	P (W)	N°Led max	L (mm)	W (mm)	H (mm)	IP Rate
NL11022	Driver 6W 350mA	220-240	350	5,6	1-4	145	65	55	IP 67
NL19019	Driver 11W 350mA	220-240	350	11,2	3-9	145	65	55	IP 67
NL19046	Driver 14W 500mA	220-240	500	13,5	1-6	145	65	55	IP 67
NL19047	Driver 20W 500mA	220-240	500	20	7-12	145	65	55	IP 67

Constant tension driver for parallel connection (outdoor use)

Code	Description	V (Vac)	I (mA)	P (W)	L (mm)	W (mm)	H (mm)	IP Rate
NL62040	Driver 40W 24Vdc	220-240	24	40	145	65	55	IP 67
NL89080	Driver 70W 24Vdc	220-240	24	70	268	66	51	IP 67
NL62880	Driver 150W 24Vdc	230-240	24	150	268	66	51	IP 67

Constant-power ballasts with plastic wrapper for parallel connection

Code	Description	V _{in} (Vac)	V _{out} (Vac)	P (VA)	L (mm)	W (mm)	H (mm)	IP Rate
T409996	Driver 25W 24Vdc	100-277	24	25	150	40	32	IP 67
T409998	Driver 60W 24Vdc	100-277	24	60	165	43	32	IP 67
T409999	Driver 90W 24Vdc	100-277	24	90	165	61	36	IP 67

Drivers

Specifications for Naiade 55 and Naiade 90 power supply

Number of fixtures which can be installed according to: Power, Cable section, Line length

Ego 55

Code	Power	Line length	Cable 1,5 mm ²	Cable 2,5 mm ²	Cable 4 mm ²
T409996	25W 24Vdc	10 m	13	13	13
	25W 24Vdc	50 m	13	13	13
	25W 24Vdc	100 m	13	13	13
	25W 24Vdc	150 m	12	12	13
	25W 24Vdc	200 m	11	12	13
T409998	60W 24Vdc	10 m	33	33	33
	60W 24Vdc	50 m	31	32	33
	60W 24Vdc	100 m	27	30	31
	60W 24Vdc	150 m	23	27	30
	60W 24Vdc	200 m	19	25	29
T409999	90W 24Vdc	10 m	49	50	50
	90W 24Vdc	50 m	43	46	48
	90W 24Vdc	100 m	35	42	46
	90W 24Vdc	150 m	26	37	42
	90W 24Vdc	200 m	19	31	39

Ego 90

Code	Power	Line length	Cable 1,5 mm ²	Cable 2,5 mm ²	Cable 4 mm ²
T409996	25W 24Vdc	10 m	5	5	5
	25W 24Vdc	50 m	5	5	5
	25W 24Vdc	100 m	4	5	5
	25W 24Vdc	150 m	4	4	5
	25W 24Vdc	200 m	4	4	4
T409998	60W 24Vdc	10 m	12	12	12
	60W 24Vdc	50 m	12	12	12
	60W 24Vdc	100 m	10	11	12
	60W 24Vdc	150 m	8	10	11
	60W 24Vdc	200 m	7	9	11
T409999	90W 24Vdc	10 m	18	18	18
	90W 24Vdc	50 m	16	17	18
	90W 24Vdc	100 m	13	16	17
	90W 24Vdc	150 m	9	14	16
	90W 24Vdc	200 m	7	12	15

Specifications for Reeds IP68 and Reeds IP68 triple power supply

Number of fixtures which can be installed according to: Power, Cable section, Line length

Reeds IP68

Code	Power	Line length	Cable 1,5 mm ²	Cable 2,5 mm ²	Cable 4 mm ²
T409996	25W 24Vdc	10 m	2	2	2
	25W 24Vdc	50 m	2	2	2
	25W 24Vdc	100 m	2	2	2
	25W 24Vdc	150 m	2	2	2
	25W 24Vdc	200 m	1	2	2
T409998	60W 24Vdc	10 m	5	5	6
	60W 24Vdc	50 m	5	5	5
	60W 24Vdc	100 m	4	4	5
	60W 24Vdc	150 m	3	4	4
	60W 24Vdc	200 m	2	3	4
T409999	90W 24Vdc	10 m	8	8	8
	90W 24Vdc	50 m	7	7	8
	90W 24Vdc	100 m	5	6	7
	90W 24Vdc	150 m	3	5	6
	90W 24Vdc	200 m	2	4	5

Reeds IP68 triple

Code	Power	Line length	Cable 1,5 mm ²	Cable 2,5 mm ²	Cable 4 mm ²
T409998	60W 24Vdc	10 m	1	1	2
	60W 24Vdc	50 m	1	1	1
	60W 24Vdc	100 m	1	1	1
	60W 24Vdc	150 m	1	1	1
	60W 24Vdc	200 m	-	1	1
T409999	90W 24Vdc	10 m	2	2	2
	90W 24Vdc	50 m	2	2	2
	90W 24Vdc	100 m	1	2	2
	90W 24Vdc	150 m	1	1	2
	90W 24Vdc	200 m	-	1	2

- Max surge supported by the ballasts: 2kV.
- Working temperature of the ballasts: -35°C + 50°C.
- The ballasts must not be directly exposed to UV-rays.
- When calculating sections/lengths, all the fixtures should be supplied with power at the line end.
- The IP67 connector supplied with the fixtures is suitable for sections from 1.5 to 4 mm².
- Insulation class II. Earthing is not required.

Constant current regulators



Code	Description	V (Vac)	I (mA)	N°Led max	L (mm)	W (mm)	H (mm)
NL11103	Régulateurs de courant constant 350mA	12	350	1-3	19	57	16
		24	350	1-6	19	57	16
NL11107	Régulateurs de courant constant 500mA	12	500	1-3	19	57	16
		24	500	1-6	19	57	16
NL11108	Régulateurs de courant constant 700mA	12	700	1-2	19	57	16
		24	700	1-5	19	57	16

Dimmable constant current regulators for outdoor use

Code	Description	V (Vac)	I (mA)	N°Led max	L (mm)	Ø (mm)	IP Rate
NL11106	Régulateurs de courant constant 350mA IP67	12	350	1-3	130	32	IP 67
		24	350	1-6	130	32	IP 67
NL11104	Régulateurs de courant constant 500mA IP67	12	500	1-3	130	32	IP 67
		24	500	1-6	130	32	IP 67
NL11102	Régulateurs de courant constant 700mA IP67	12	700	1-2	130	32	IP 67
		24	700	1-5	130	32	IP 67

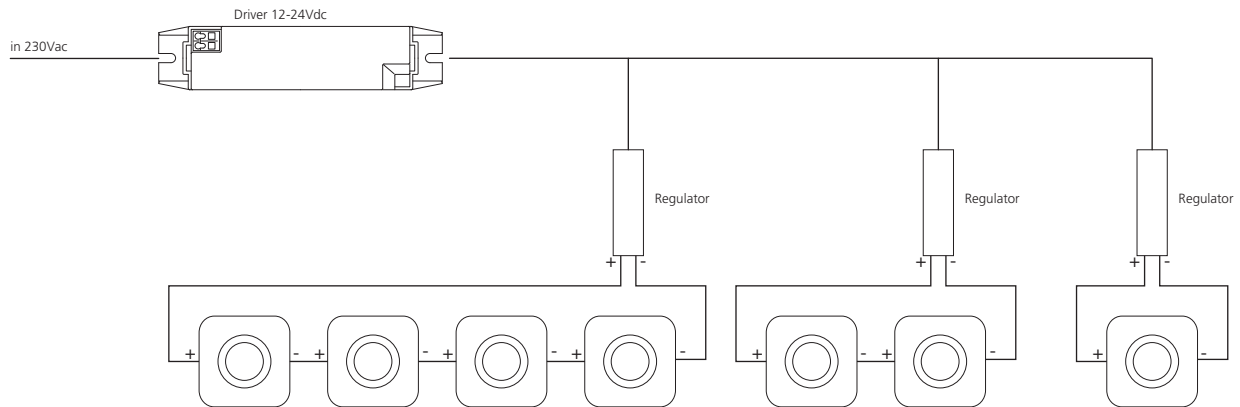

RGB control systems

Artemide Drivers and controller allow a flexible and fully programmable dynamic lighting System. The LED Drivers are compatible with the USITT DMX 512 Standard which is a simple, reliable and economic light management and can be easily interfaced with modern domotic Systems. The DMX data lines are electrically opto-isolated to ensure the maximal reliability and to avoid disturbances.

Wiring diagram for RGB LED systems RGB

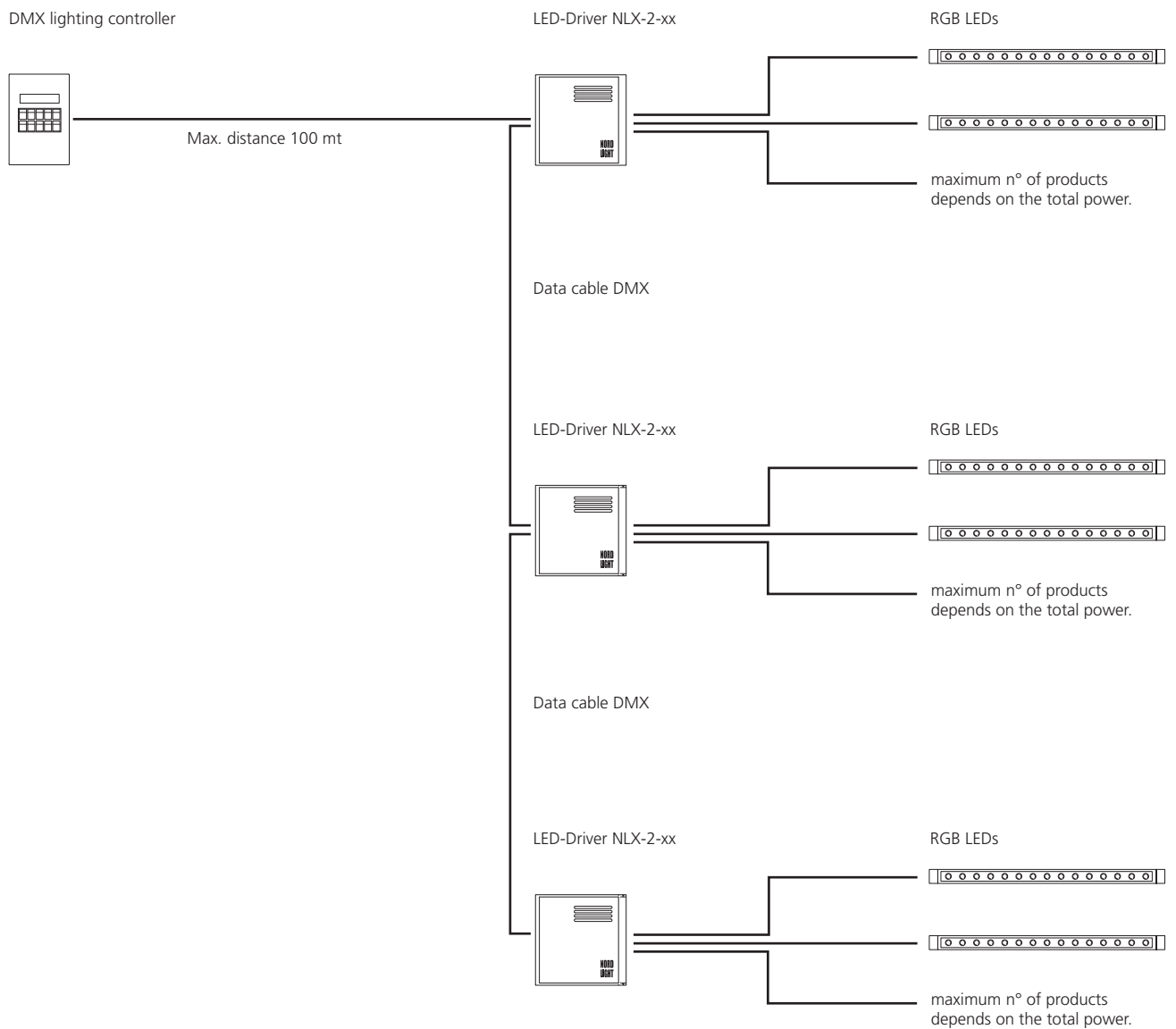

Controllers DMX



NL75130		DMX lighting controller DSC10					
Data In	Data Out	DMX ch.	Scenes	Driver	Data cable	L x W x H (mm)	Weight (kg)
No	DMX	60	40	12Vdc - 1A incl.	DMX 2m/XLR	125x170x55	1,5

This lighting controller is able to memorise up to 40 scenes and to manage up to 6 sequences with maximum of 24. The sequences can be chosen by pushing the corresponding buttons on the keyboard. Programming has been implemented via a keyboard and LCD display.



NL19030		DSC30 USB interface - DMX stand alone					
Data In	Data Out	DMX ch.	Scenes	Driver	Data cable	L x W x H (mm)	Weight (kg)
USB	DMX	2x512 stand alone	255	5-5,5Vdc - 300mA excl.	DMX 2m/XLR + USB	80x40x90	0,7
USB	DMX	2x512 live	255	5-5,5Vdc - 300mA excl.	DMX 2m/XLR + USB	80x40x90	0,7
NL19031		5Vdc 300mA plug-in power supply Mini-USB					
NL7833		50cm cable with HE10 connector for keyboard (optional)					

Standard USB-DMX "Stand Alone" interface (512 channels, real-time clock, Local use), software, USB cable. Live mode with a computer; Stand Alone mode. Scenes can be triggered in sequential or using external push-buttons to trigger for instance 8 Scenes. Upon request: connection to external keyboard or to domotics Systems. Needs an external power supply for the Stand Alone mode. Upon request: connection to external keyboard or to domotics Systems.



NL19081		DSC60 USB/Ethernet Interface					
Data In	Data Out	DMX ch.	Scenes	Driver	Data cable	L x W x H (mm)	Weight (kg)
Ethernet	DMX	2x512	250	5-5,5Vdc - 300mA excl.	DMX 2m/XLR + Ethernet	80x40x90	0,7
NL19031		5Vdc 300mA plug-in power supply Mini-USB					

Standard USB and Ethernet DMX "Stand Alone" Interface (2x512 channels), with software, USB cable, 3 DMX 512 universes in live mode with a computer (not included); 2 DMX512 universes in stand-alone mode. Micro sd-card memory for stand-alone use, 8 dry contact trigger ports via HE10 connector (upon request). Clock & calendar function. Stand-alone mode with 5 areas and 250 scenes. WIFI remote control option with smart phone/tablet (IOS, ANDROID, Windows, Linux) to trigger scene. Simply connect to your wireless local network, the WIFI remote control app will automatically find the interface and allow you to control it. A second application, compatible with any IOS and ANDROID smart phones or tablets, allows you to easily create or change the lighting surroundings in each area. In just a few steps, you'll be able to take control of all your DMX fixtures in live, or Stand Alone mode. The simple application can be used by just about everyone in any situation. The interface needs an external power supply for the Stand Alone mode.



NL19080		DSC70 USB Glass Touch Sensitive Control Keypad					
Data In	Data Out	DMX ch.	Scenes	Driver	Data cable	L x W x H (mm)	Weight (kg)
USB	DMX	512	99	5-12Vdc - 300mA excl.	RJ45 + USB	110x86x10	0,2
NL19083		5Vdc 300mA plug-in power supply					

Thanks to the "All-in-One" technology, the DSC70 includes a high-tech keypad, stand-alone memory storage and a powerful DMX512 lighting software package. It offers the best solution for projects requiring a large amount of scenes along with an uncluttered and intuitive interface. The computer programmable, flat wall mounted lighting controller is ideal for LED, RGB & DMX lighting and capable of playing up to 99 scenes, each of which can be modified by touching the mode button to change the dimmer and color. The LED display makes it easy to tell which scene number is playing. The wall panel allows it to be mounted on any single gang wall socket around the world. Large memory capacity, 4 touch sensitive buttons, glass wall-mounted DMX controller. Micro-USB for programming. For PC, Mac & Tablet with USB. 32bit RM technology, software included. Stand alone operation. Ready to use (pre-loaded). The interface needs an external power supply which can be placed in the gang wall socket.



NL110540		DSC50 USB interface - DMX stand alone					
Data In	Data Out	DMX ch.	Scenes	Driver	Data cable	L x W x H (mm)	Weight (kg)
USB	DMX	512	512	USB	2m/XLR	78x48x28	1,0

The DSC50 permits synchronisation of light scenario with audio signal by means of the specific interface. This feature makes it ideal for all installations where light must act together with the soundtrack. Up to 60 DMX512 interfaces can be connected to a single USB host controller without having any frame rate loss, for a maximum of 30720 DMX channels. Available with advanced Light Control Software, can be fully synchronised per DMX-IN, Art-Net Remote, Remote HTTP, MIDI and Touch Screen.

Attention: The DMX controller is not required with just one LED-Driver.

LED Drivers



LED Driver NLX IP40

Code	Description	P (W)	V _{in}	V _{out} (Vdc)	L x W x H (mm)	Weight (kg)
NL19050	NLX 2-50	50	100-240 Vac	24	270x200x80	1,4
NL75190	NLX 2-75	75	100-240 Vac	24	270x200x80	1,4
NL19084	NLX 1-75	75	12-24 Vdc	12-24	153x50x23	0,2
NL82030	NLX 2-100	100	100-240 Vac	24	270x240x85	2,0
NL80220	NLX 2-150	150	100-240 Vac	24	270x240x85	2,0



LED Driver NLX IP65

Code	Description	P (W)	V _{in}	V _{out} (Vdc)	L x W x H (mm)	Weight (kg)
NL81260	NLX 2-70	70	100-240	24	280x210x80	2,0
NL84100	NLX 2-100	100	100-240	24	280x210x80	2,0
NL77270	NLX 2-150	150	100-240	24	280x210x80	2,0

PWM Driver for LED units with pre-installed colour-programmes for an independent stand-alone Mode or operation through the DMX512 protocol. The DMX interface allows lighting systems of any size and can be easily integrated with domotic Systems.



LED Driver NLX with push button stop control IP40

Code	Description	P (W)	V _{in}	L x W x H (mm)	Weight (kg)
NL19051	NLX 2-50	50	100-240	270x200x80	1,4
NL81910	NLX 2-75	75	100-240	270x200x80	1,4
NL80210	NLX 2-100	100	100-240	270x240x85	2,0
NL80510	NLX 2-150	150	100-240	270x240x85	2,0

PWM Driver for LED units with pre-installed colour programmes for an independent stand-alone mode. With a remote push-button it is possible to switch ON/OFF, freeze or reactivate colour sequences. Function with DMX-Controller disabled.

Max distance between LED driver and RGB products.

Fixture	Max distance from driver	Fixture	Max distance from driver
Spike IP40 RGB	20m	Riga Plus RGB	20m
Spike IP40 RGB Incasso	20m	Ego Mini 15 RGB	20m
Spike IP65 RGB	20m	Ego 72 RGB	20m
SuperSpike RGB	20m	Ego 72 Spot RGB	20m
Label Light IP65 RGB	20m	Starled RGB	20m
Riga RGB	20m		

Example of Wi-Fi control of the RGB system

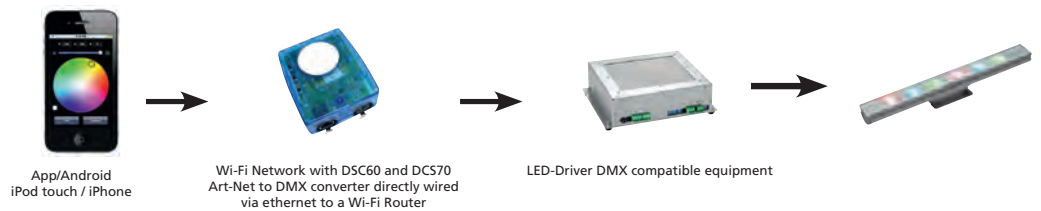

Special devices for projects

Code	Description
NL78070	Splitter DMX 1 in to 8 out



Device in order to realize star wiring between Systems driver RGB and controller DMX. 1 cable 250cm/XLR female + 8 cables 250cm/XLR male incl. Standard Rack 482 x 44 x 128mm 90-240Vac.

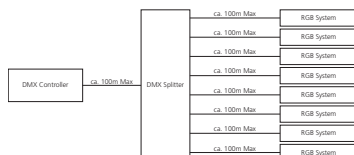

Push button dimmers

Dimmer

This product contains the dimming circuit and can be used to dim any Artemide product. The dimming circuit must be used in conjunction with the drivers with appropriate constant current (Volt=12/15/24Vdc page 317).

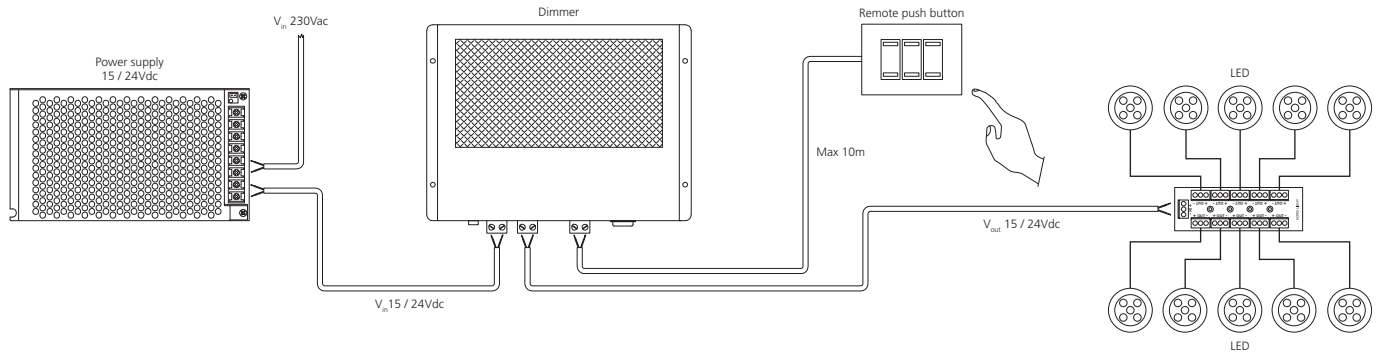

Code	Description	Signal	V (Vdc)	I (A)	P (W)	L (mm)	W (mm)	H (mm)
NL19008	Dimmer 6A 12Vdc push button DIN rail	Push button	12	6	72	52	95	90
NL11478	Dimmer 8A 12Vdc push button + box	Push button	12	8	96	180	110	80
NL19012	Dimmer 10A 12Vdc push button + box	Push button	12	10	120	220	165	80
NL19009	Dimmer 6A 15Vdc push button DIN rail	Push button	15	6	90	52	95	90
NL19011	Dimmer 8A 15Vdc push button + box	Push button	15	8	120	180	110	80
NL59250	Dimmer 10A 15Vdc push button + box	Push button	15	10	150	220	165	80
NL19010	Dimmer 6A 24Vdc push button DIN rail	Push button	24	6	144	52	95	90
NL10763	Dimmer 8A 24Vdc push button + box	Push button	24	8	192	180	110	80
NL59240	Dimmer 10A 24Vdc push button + box	Push button	24	10	240	220	165	80

Lighting management

The Artemide technical office specialises in the planning and realization of lighting control systems. A domotic system is typically consists of:

- control module 0-10V (chosen by the client)
- dimmer for domotic system
- constant current driver for domotic system

V 0-10V dimming signal

Code	Description	Signal	V (Vdc)	I (A)	P (W)	L (mm)	W (mm)	H (mm)
NL19013	Dimmer 6A 12Vdc 0-10V DIN rail	0-10V	12	6	72	52	95	90
NL19015	Dimmer 8A 12Vdc 0-10V + box	0-10V	12	8	96	180	110	80
NL19018	Dimmer 10A 12Vdc 0-10V + box	0-10V	12	10	120	220	165	80
NL19014	Dimmer 6A 15Vdc 0-10V DIN rail	0-10V	15	6	90	52	95	90
NL19016	Dimmer 8A 15Vdc 0-10V + box	0-10V	15	8	120	180	110	80
NL58980	Dimmer 10A 15Vdc 0-10V + box	0-10V	15	10	150	220	165	80
NL84070	Dimmer 6A 24Vdc 0-10V DIN rail	0-10V	24	6	144	52	95	90
NL19017	Dimmer 8A 24Vdc 0-10V + box	0-10V	24	8	192	180	110	80
NL58960	Dimmer 10A 24Vdc 0-10V + box	0-10V	24	10	240	220	165	80

Dimmer with potentiometer

Code	Description	Signal	V (Vdc)	I (A)	P (W)	L (mm)	W (mm)	H (mm)
NL19003	Dimmer 8A 12Vdc + box	Potentiometer	12	8	96	180	110	80
NL19005	Dimmer 10A 12Vdc + box	Potentiometer	12	10	120	220	165	80
NL19004	Dimmer 8A 15Vdc + box	Potentiometer	15	8	120	180	110	80
NL19006	Dimmer 10A 15Vdc + box	Potentiometer	15	10	150	220	165	80
NL18001	Dimmer 8A 24Vdc + box	Potentiometer	24	8	192	180	110	80
NL19007	Dimmer 10A 24Vdc + box	Potentiometer	24	10	240	220	165	80

Dimmer DALI/Push

Code	Description	Signal	V (Vdc)	I (A)	P (W)	L (mm)	W (mm)	H (mm)	
NL19090	Dimmer DALI	DALI	10-24	5	120 max	172	42	20	IP20
NL19096	Dimmer Master	DALI	12-24	12	288 max	156	52	26	IP20
NL19097	Dimmer SLAVE + NL19096	DALI	12-24	12	288 max	156	52	26	IP20

Presence and brightness sensors



Room in use. Operation with movement detector and daylight control.

To complement the standard versions with or without a dimmer, Artemide Architectural is showcasing the Interactive-Dali, a system that combines personalised control of lighting, ensuring optimum convenience of use, and automatic management of the switching on and off cycles for a rational use of energy.

Multiple operating situations can be set due to the integration of interactive and adjustable electronic components, such as a movement detector, ambient light sensor and infrared receiver.

With Interactive-Dali, lighting is activated automatically when the room is in use and there is not enough natural light.



Empty room. Timed lowering of light intensity.

Depending on personal characteristics (clearness of vision, required concentration, possible tiredness, etc.), or the nature of the activities being carried out (personal work, meeting, video projection, etc.), the user can optimise the comfort level by regulating the amount of light, simply by using a switch or an optional remote control. After this simple setting, the system will automatically manage the operation of the device to keep the amount of light constant according to the daylight.

When the room is not being used, the light is automatically lowered and then switched off by a programmable timer.

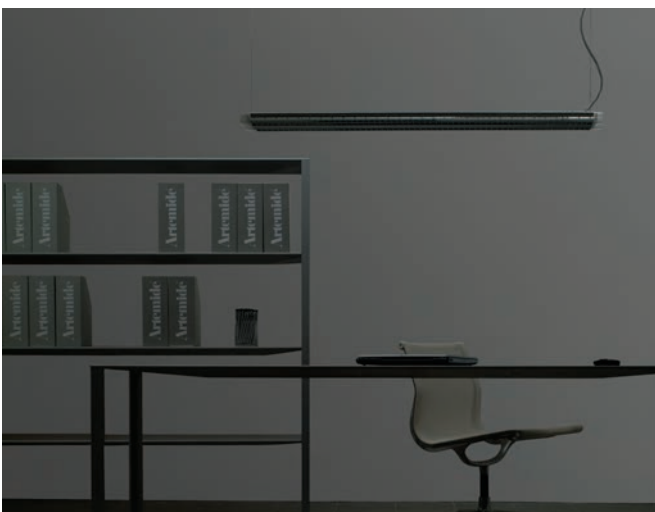

Empty room. Complete switch off.

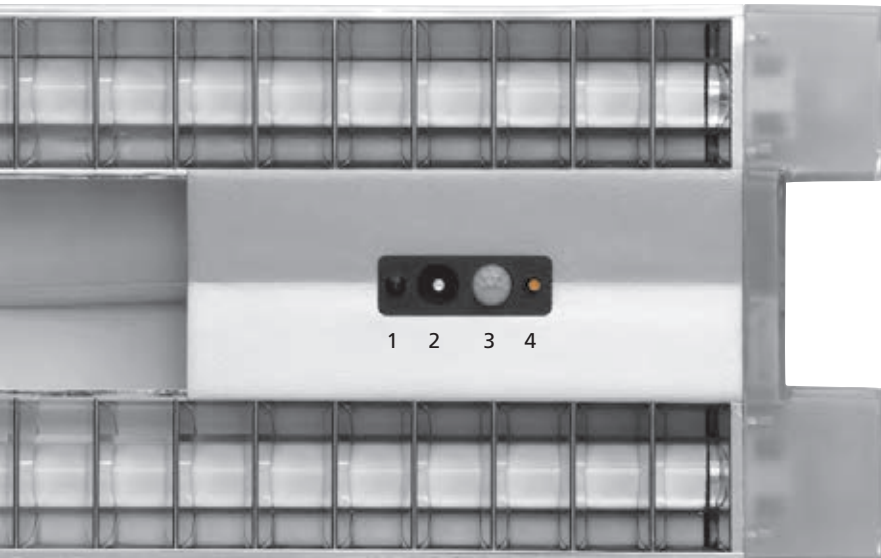

- 1 Infrared detector.
- 2 Daylight sensor.
- 3 Movement detector.
- 4 Service button
(for programme selection).

Interactive-Dali technology is used in stand-alone devices, in some devices belonging to the same family connected to each other or to external Interactive-Dali components (such as a supplementary movement detector). No interconnection is therefore required to a Dali system already in the room.

Main advantages

High level of personalised operation. "Plug and play" connection without the need to change the existing electrical system. Option to manage up to ten devices, which may be divided into two groups. Energy savings will bring a return on the investment.

Interactive Dali Devices

The master module (fitted with the Interactive-Dali system) can be connected to up to 10 other dimmable Dali devices. It is operated by an Interactive-Dali remote control or an external or integrated button.

Dali Devices

For products with a Dimmable-Dali power supply unit, an external Interactive-Dali kit can be used, which can be fitted into the ceiling. This kit can control up to 11 Dali devices (slave modules). It is operated by an Interactive-Dali remote control or button.

Interactive-Dali components



Interactive-Dali kit, Ø86mm, white, recessed.
Can be connected to up to 11 dimmable Dali units. It is operated by an Interactive-Dali remote control or button.

⌀72 mm

Code
M074030



Supplementary movement detector white, recessed.
For use when the area to be covered is greater than 6.00 x 5.00m x h 2.5m. To be connected to one of the outputs of the Interactive-Dali control module. No further connections are needed.

⌀64 mm

M074130



Interactive-Dali remote control.

M104900

Codes index

1532010A	836	L171520	107	L596850	242	M004305	870	M016931	551	M018840	537	M020140	553	M029500	154
1534010A	836	L171521	107	L596860	242	M004325	870	M016937	551	M018860	537	M020141	553	M029600	154
1535010A	836	L171530	107	L596920	242	M004340	870	M016940	551	M018910	534	M020160	553	M032500	445
1536010A	836	L171531	107	L596950	242	M004350	870	M016941	551	M018920	534	M020161	553	M032600	445
L170020	106	L171620	106	L596960	242	M004355	870	M016947	551	M018930	534	M020210	524	M032700	445
L170021	106	L171630	106	L597610	243	M004360	870	M016960	550	M018940	534	M020220	524	M032800	445
L170030	106	L171670	106	L597620	243	M004365	870	M016961	550	M018960	534	M020230	524	M033500	591
L170031	106	L171720	106	L597710	243	M004370	870	M016967	550	M019110	546	M020240	524	M033501	591
L170070	106	L171730	106	L597720	243	M004371	870	M017010FL	535	M019120	546	M020710	525	M033600	591
L170071	106	L171770	106	L597810	243	M004380	870	M017010MFL	535	M019130	546	M020720	525	M033601	591
L170120	106	L171820	107	L597820	243	M004381	870	M017010SP	535	M019140	546	M020730	525	M033700	591
L170121	106	L171821	107	L597910	243	M004400	870	M017020FL	535	M019160	546	M020740	525	M033701	591
L170130	106	L171830	107	L597920	243	M004410	870	M017020MFL	535	M019210	547	M020810	525	M033800	591
L170131	106	L171831	107	L860410	564	M004420	870	M017020SP	535	M019220	547	M020820	525	M033801	591
L170170	106	L171870	107	L860450	564	M004500	870	M017030FL	535	M019230	547	M020830	525	M036211	451
L170171	106	L171871	107	L860510	562	M004570	870	M017030MFL	535	M019240	547	M020840	525	M036216	451
L170220	106	L172020	107	L860550	564	M004630	870	M017030SP	535	M019260	547	M020910FL	525	M036221	451
L170221	106	L172021	107	L860610	562	M004660	870	M017040FL	535	M019310FL	547	M020910MFL	525	M036226	451
L170230	106	L172030	107	L860650	562	M004720	872	M017040MFL	535	M019310MFL	547	M020910SP	525	M036311	451
L170231	106	L172031	107	L860710	562	M004760	872	M017040SP	535	M019310SP	547	M020920FL	525	M036316	451
L170270	106	L172620	108	L860750	562	M004765	872	M017060FL	535	M019320FL	547	M020920MFL	525	M036321	451
L170271	106	L172621	108	L860810	564	M004770	872	M017060MFL	535	M019320MFL	547	M020920SP	525	M036326	451
L170320	106	L172720	108	L864000	562	M004775	872	M017060SP	535	M019320SP	547	M020930FL	525	M036411	452
L170321	106	L172721	108	L864050	562	M004800	339	M017300	263	M019330FL	547	M020930MFL	525	M036416	452
L170330	106	L172820	108	L864100	562	M004805	339	M017400	263	M019330MFL	547	M020930SP	525	M036421	452
L170331	106	L172821	108	L864150	562	M004810	339	M017710	541	M019330SP	547	M020940FL	525	M036426	452
L170370	106	L173220	108	M001010	873	M004815	339	M017711	541	M019340FL	547	M020940MFL	525	M036511	452
L170371	106	L173221	108	M001020	873	M004830	871	M017720	541	M019340MFL	547	M020940SP	525	M036516	452
L170420	106	L173320	108	M001155	873	M004835	871	M017721	541	M019340SP	547	M021010	528	M036521	452
L170430	106	L173400	108	M001160	873	M016010	530	M017730	541	M019360FL	547	M021011	528	M036526	452
L170620	106	L173420	107	M001165	873	M016011	530	M017731	541	M019360MFL	547	M021020	528	M038500	260
L170621	106	L173430	107	M001170	873	M016017	530	M017740	541	M019360SP	547	M021021	528	M038505	260
L170630	106	L176000	106	M001175	873	M016020	530	M017741	541	M019410	549	M021030	528	M038700	260
L170631	106	L176100	106	M001180	873	M016021	530	M017760	541	M019411	549	M021031	528	M038705	260
L170670	106	L176200	106	M001185	873	M016027	530	M017761	541	M019420	549	M021040	528	M038800	260
L170671	106	L176320	98	M001195	873	M016030	530	M017810	547	M019421	549	M021041	528	M038805	260
L170720	106	L176330	98	M001220	873	M016031	530	M017820	547	M019430	549	M021110	528	M039000	260
L170721	106	L176370	98	M001300	873	M016037	530	M017830	547	M019431	549	M021111	528	M039005	260
L170730	106	L176420	108	M001310	873	M016040	530	M017840	547	M019440	549	M021120	528	M039100	262
L170731	106	L176421	108	M001330	873	M016041	530	M017860	547	M019441	549	M021121	528	M039105	262
L170770	106	L176520	108	M001340	873	M016047	530	M018210	535	M019460	549	M021130	528	M039300	262
L170771	106	L176521	108	M001360	873	M016710	540	M018220	535	M019461	549	M021131	528	M039305	262
L170920	107	L220480	777	M001365	873	M016711	540	M018230	535	M019510	549	M021140	528	M039400	262
L170921	107	L220490	777	M001370	873	M016717	540	M018240	535	M019511	549	M021141	528	M039405	262
L170930	107	L221180	777	M001390	873	M016720	540	M018260	535	M019520	549	M021210	528	M039600	262
L170931	107	L221190	777	M001395	873	M016721	540	M018310	535	M019521	549	M021220	528	M039605	262
L170970	107	L222180	777	M003030	871	M016727	540	M018320	535	M019530	549	M021230	528	M041800	266
L170971	107	L222190	777	M003080	871	M016730	540	M018330	535	M019531	549	M021240	528	M041900	266
L171020	107	L225480	777	M003090	871	M016731	540	M018340	535	M019540	549	M021310	528	M042200	266
L171021	107	L225490	777	M003150	871	M016737	540	M018360	535	M019541	549	M021320	528	M042300	266
L171030	107	L227180	777	M003155	871	M016740	540	M018510	537	M019560	549	M021330	528	M044200	266
L171031	107	L227190	777	M003160	871	M016741	540	M018511	537	M019561	549	M021340	528	M044300	266
L171070	107	L2280180	776	M003165	871	M016747	540	M018520	537	M019610	549	M021510	531	M044600	266
L171071	107	L2280190	776	M003170	871	M016760	540	M018521	537	M019620	549	M021511	531	M044700	266
L171120	107	L228080	776	M003175	871	M016761	540	M018530	537	M019630	549	M021520	531	M047905	262
L171121	107	L228090	776	M003178	871	M016767	540	M018531	537	M019640	549	M021521	531	M048800	262
L171130	107	L2281180	776	M003185	871	M016810	551	M018540	537	M019660	549	M021530	531	M048805	262
L171131	107	L2281190	776	M003190	871	M016811	551	M018541	537	M019710	549	M021531	531	M049000	262
L171170	107	L228180	776	M003260	871	M016817	551	M018560	537	M019720	549	M021540	531	M049005	262
L171171	107	L228190	776	M003270	871	M016820	551	M018561	537	M019730	549	M021541	531	M049010	262
L171220	107	L2282180	776	M003275	871	M016821	551	M018610	537	M019740	549	M024120	499	M049015	262
L171221	107	L2282190	776	M003280	871	M016827	551	M018611	537	M019760	549	M024190	499	M049060	262
L171230	107	L228280	776	M003290	871	M016830	551	M018620	537	M019910	553	M024220	499	M049065	262
L171231	107	L228290	776	M003310	871	M016831	551	M018621	537	M019911	553	M024290	499	M049070	262
L171270	107	L2283180	776	M003320	871	M016837	551	M018630	537	M019920	553				

M0569N81	50	M070211	263	M083737	104	M107520	512	M119320	581	M140910	72	M141950	80	M155000	466
M0569N83	50	M070322	273	M083817	98	M107590	512	M119420	581	M140911	72	M141980	80	M155001	466
M0569W81	50	M070412	273	M083837	98	M107620	512	M129820	276	M140920	72	M142211	77	M155007	466
M0569W83	50	M070422	138	M083917	98	M107621	512	M129920	276	M140921	72	M142221	77	M155100	466
M057080	55	M070522	138	M083937	98	M107627	512	M133600	276	M140950	72	M142251	77	M155101	466
M057381	60	M070622	273	M090020	472	M107690	512	M133700	276	M140951	72	M142281	77	M155107	466
M057383	60	M071232	525	M090090	472	M107691	512	M135200	276	M140980	72	M142311	77	M155600	466
M057481	60	M072111	138	M090120	472	M107697	512	M135310	506	M140981	72	M142321	77	M156000	466
M057483	60	M072111	145	M090190	472	M107720	512	M135311	506	M141010	72	M142351	77	M156100	466
M057500	45	M073230	339	M090220	473	M107790	512	M135320	506	M141011	72	M142381	77	M156200	466
M057600	45	M073240	339	M090290	473	M107820	512	M135321	506	M141020	72	M146200	330	M156300	466
M057781	37	M074030	473	M090320	473	M107821	512	M135410	507	M141021	72	M146201	330	M156400	466
M057783	37	M074130	473	M090390	473	M107827	512	M135411	507	M141050	72	M146300	330	M156600	466
M057800	61	M074600	187	M090420	473	M107890	512	M135420	507	M141051	72	M146301	330	M156700	466
M059910	55	M075000	315	M090490	473	M107891	512	M135421	507	M141080	72	M146400	330	M157420	556
M060120	478	M075100	315	M090520	473	M107897	512	M135510	507	M141081	72	M146401	330	M157520	556
M060121	478	M076100	315	M090590	473	M108020	513	M135511	507	M141110	72	M146500	330	M157620	556
M060190	478	M076200	187	M090620	473	M108120	513	M135520	507	M141111	72	M146501	330	M157720	556
M060191	478	M076300	187	M090690	473	M108190	513	M135521	507	M141120	72	M146620	350	M157820	556
M060220	478	M076400	187	M090720	473	M108220	513	M135610	507	M141121	72	M146621	350	M160400	598
M060221	478	M076500	187	M090790	473	M108290	513	M135611	507	M141150	72	M146660	350	M160401	598
M060290	478	M076600	187	M090820	473	M108320	513	M135620	507	M141151	72	M146661	350	M160402	598
M060291	478	M076800	211	M090890	473	M108420	512	M135621	507	M141180	72	M146720	350	M160407	598
M060720	479	M076900	211	M090920	473	M108490	512	M135710	507	M141181	72	M146721	350	M160421	598
M060790	479	M077000	315	M090990	473	M108520	512	M135711	507	M141210	72	M146760	350	M160600	598
M060955	478	M077100	315	M091125	472	M108590	512	M135720	507	M141211	72	M146761	350	M160602	598
M060966	478	M077200	315	M091195	472	M108620	512	M135721	507	M141220	72	M146820	350	M160700	597
M061520	479	M077300	315	M091220	472	M108690	512	M135810	506	M141221	72	M146821	350	M160701	597
M061590	479	M077401	524	M091290	472	M108720	512	M135811	506	M141250	72	M146860	350	M160702	597
M062300	270	M077500	200	M091320	472	M108790	512	M135820	506	M141251	72	M146861	350	M160707	597
M062305	270	M077600	252	M091390	472	M109020	516	M135821	506	M141280	72	M146920	350	M160721	597
M062500	270	M077700	248	M091520	472	M109021	516	M135910	506	M141281	72	M146921	350	M162400	595
M062505	270	M077810	73	M091590	472	M109027	516	M135911	506	M141310	72	M146960	350	M162401	595
M062620	271	M077820	73	M091820	473	M109090	516	M135920	506	M141311	72	M146961	350	M162402	595
M062720	271	M077850	73	M091890	473	M109091	516	M135921	506	M141320	72	M147920	350	M162407	595
M063220	272	M077880	73	M094520	472	M109097	516	M136410	507	M141321	72	M147921	350	M162421	595
M063320	273	M077900	198	M094590	472	M109120	516	M136420	507	M141350	72	M147960	350	M163520	591
M063520	273	M078400	73	M094620	472	M109121	516	M136510	507	M141351	72	M147961	350	M163810	455
M063620	273	M078500	73	M094690	472	M109190	516	M136520	507	M141380	72	M148020	350	M163811	455
M064020	271	M078600	73	M094720	472	M109191	516	M136610	507	M141381	72	M148021	350	M163816	455
M064120	271	M078700	73	M094790	472	M109220	517	M136620	507	M141410	72	M148060	350	M163820	455
M064420	272	M078800	73	M094820	472	M109221	517	M136700	276	M141411	72	M148061	350	M163821	455
M064620	272	M078900	73	M094890	472	M109290	517	M137620	276	M141420	72	M148120	350	M163826	455
M064720	272	M079000	73	M094925	472	M109291	517	M137720	276	M141421	72	M148121	350	M163910	454
M064820	273	M079100	73	M094926	472	M109320	517	M137800	276	M141450	72	M148160	350	M163911	454
M064900	271	M079200	197	M094995	472	M109321	517	M137900	277	M141451	72	M148161	350	M163916	454
M065000	272	M079300	197	M094996	472	M109390	517	M138820	277	M141480	72	M148220	350	M163919	454
M065200	270	M080008	263	M095120	472	M109391	517	M138920	277	M141481	72	M148221	350	M163920	454
M065205	270	M080018	263	M095121	472	M109500	52	M139000	277	M141510	72	M148260	350	M163921	454
M065300	270	M080028	263	M095190	472	M109600	52	M139200	277	M141511	72	M148261	350	M163926	454
M065305	270	M080038	263	M095191	472	M109700	52	M139420	277	M141520	72	M148320	350	M163929	454
M066220	479	M080085	272	M095220	472	M109800	52	M139520	277	M141521	72	M148321	350	M164110	454
M066290	479	M080535	104	M095221	472	M109900	52	M139720	277	M141550	72	M148360	350	M164111	454
M066355	478	M080545	98	M095290	472	M112410	458	M139820	277	M141551	72	M148361	350	M164116	454
M066366	478	M080800	98	M095291	472	M112420	458	M140610	72	M141580	72	M148420	350	M164119	454
M066981	37	M081717	98	M097620	472	M112510	458	M140611	72	M141581	72	M148421	350	M164120	454
M0671N81	50	M081737	98	M097690	472	M112520	458	M140620	72	M141610	72	M148460	350	M164121	454
M0671W81	50	M082617	98	M104900	473	M112610	458	M140621	72	M141611	72	M148461	350	M164126	454
M0672N81	60	M082637	98	M106620	510	M112620	458	M140650	72	M141620	72	M149620	350	M164129	454
M0672W81	60	M082717	98	M106690	510	M112710	458	M140651	72	M141621	72	M149621	350	M164200	454
M0676N81	50	M082737	98	M106720	510	M112720	458	M140680	72	M141650	72	M149660	350	M164510	459
M0676W81	50	M082817	98	M106790	510	M113020	582	M140681	72	M141651	72	M149661	350	M164520	459
M0677N81	60	M082837	98	M106820	510	M113120	582	M140710	72	M141680	72	M149720	350	M164610	459
M0677W81	44	M082917	104	M106890	510	M113220	583	M140711	72	M141681	72	M149721	350	M164620	459
M0677W81	44	M082937	104	M106920	510	M113300	574	M140720	72	M141710	72	M149760	350	M164710	457
M0677W81	60	M083017	98	M106990	510	M113301	574	M140721	72	M141711	72	M149761	350	M164720	457
M067881	37	M083037	98	M107020	510	M113400	574	M140750	72	M141720	72	M151500	330	M164810	457
M069025	136	M083117	104	M107090	510	M113401	574	M140751	72	M141721	72	M151501	330	M164811	457
M069055	136	M083137	104	M107120	510	M113610	457	M140780	72	M141750	72	M151600	330	M164820	457
M069125	136	M083317	104	M107121	510	M113611	457	M140781	72	M141751	72	M151601	330	M164821	457
M069155	136	M083337	104	M107190	510	M113620	457	M140810	72	M141780	72	M151700	330	M166720	494
M069225	137	M083417	104	M107191	510	M113621	457	M140811	72	M141781	72	M151701	330	M166721	494
M069255	137	M083437	104	M107220	510	M113710	457	M140820	72	M141810	80	M151800	330	M166790	494
M069325	137	M083517	104	M107290	510	M113711	457	M140821	72	M141820	80	M151801	330	M166791	494
M069355	137	M083537	104	M107320	510	M113720	457	M140850	72	M141850	80	M154500	367	M166820	494
M069525	137	M083617	104	M107321	510	M113721	457	M140851	72	M141880	80	M154501	467	M166890	494
M069625	137	M083637	104	M107390	510	M119120	580	M140880	72	M141910	80	M154600	467	M166920	494
M070032	263	M083717	104	M107391	510	M119220	580	M140881	72	M141920	80	M154601	467	M166921	494

Codes index

M166990	494	M172001	142	M197300	324	M202260	384	M205720	351	M222363	94	M224343SP	97	M228360	388
M166991	494	M174220	556	M197400	338	M202261	384	M205721	351	M222433	94	M224343WFL	97	M228420	388
M167020	494	M174221	556	M197500	338	M202320	384	M205760	351	M222443	94	M224363FL	97	M228460	388
M167021	494	M174320	556	M197800	331	M202321	384	M205761	351	M222463	94	M224363MFL	97	M228720	387
M167090	494	M174321	556	M197900	339	M202360	384	M206320	326	M222533	94	M224363SP	97	M228721	387
M167091	494	M175420	556	M198000	339	M202361	384	M206360	326	M222543	94	M224363WFL	97	M228760	387
M167120	495	M175421	556	M198100	339	M202420	384	M206820	354	M222563	94	M224733FL	97	M228761	387
M167121	495	M175520	556	M198200	339	M202421	384	M206821	354	M222633	94	M224733MFL	97	M228820	387
M167190	495	M175521	556	M198300	339	M202460	384	M206860	354	M222643	94	M224733SP	97	M228821	387
M167191	495	M175620	556	M198400	339	M202461	384	M206861	354	M222663	94	M224733WFL	97	M228860	387
M167220	495	M175621	556	M198500	339	M202520	384	M206920	354	M222733	94	M224743FL	97	M228861	387
M167221	495	M175720	556	M198600	339	M202521	384	M206921	354	M222743	94	M224743MFL	97	M229320	388
M167290	495	M175721	556	M198700	339	M202560	384	M206960	354	M222763	94	M224743SP	97	M229360	388
M167291	495	M175820	556	M198800	339	M202561	384	M206961	354	M222833	94	M224743WFL	97	M229420	388
M167500	380	M175821	556	M198900	339	M202620	384	M207020	354	M222843	94	M224763FL	97	M229460	388
M167600	380	M175920	556	M199000	339	M202621	384	M207021	354	M222863	94	M224763MFL	97	M229533	96
M167700	380	M175921	556	M199300	327	M202660	384	M207060	354	M222933	94	M224763SP	97	M229543	96
M167820	482	M178820	556	M199400	327	M202661	384	M207061	354	M222943	94	M224763WFL	97	M229563	96
M167821	482	M178920	556	M199520	326	M202720	384	M207120	354	M222963	94	M224833MFL	97	M229633	96
M167826	482	M179020	556	M199560	326	M202721	384	M207121	354	M223133	95	M224833MFL	97	M229643	96
M167829	482	M179120	556	M199600	338	M202760	384	M207160	354	M223143	95	M224833SP	97	M229663	96
M167890	482	M179220	556	M199700	338	M202761	384	M207161	354	M223163	95	M224833WFL	97	M229733	96
M167891	482	M181320	497	M199800	338	M202820	384	M207220	354	M223433FL	95	M224843FL	97	M229743	96
M167896	482	M181321	497	M199900	338	M202821	384	M207221	354	M223433MFL	95	M224843MFL	97	M229763	96
M167899	482	M181390	497	M200001	170	M202860	384	M207260	354	M223433SP	95	M224843SP	97	M229833	96
M168020	482	M181391	497	M200002	170	M202861	384	M207261	354	M223443FL	95	M224843WFL	97	M229843	96
M168021	482	M181420	497	M200003	170	M202920	384	M207320	354	M223443MFL	95	M224863FL	97	M229863	96
M168026	482	M181490	497	M200004	171	M202921	384	M207321	354	M223443SP	95	M224863MFL	97	M230000	365
M168029	482	M181520	497	M200101	170	M202960	384	M207360	354	M223463MFL	95	M224863SP	97	M230100	365
M168090	482	M181521	497	M200102	170	M202961	384	M207361	354	M223463SP	95	M224863WFL	97	M230200	365
M168091	482	M181590	497	M200103	170	M203020	384	M207420	355	M223533FL	95	M225433MFL	103	M230300	365
M168096	482	M181591	497	M200104	171	M203021	384	M207460	355	M223533MFL	95	M225433WFL	103	M230400	365
M168099	482	M181620	497	M200201	170	M203060	384	M207520	355	M223533SP	95	M225433WFL	103	M230500	365
M168200	482	M181621	497	M200202	170	M203061	384	M207560	355	M223543FL	95	M225443MFL	103	M230600	365
M168420	486	M181690	497	M200203	170	M203120	384	M207620	355	M223543MFL	95	M225443WFL	103	M230700	365
M168421	486	M181691	497	M200204	171	M203121	384	M207660	355	M223543SP	95	M225443WFL	103	M230900	365
M168426	486	M181700	365	M200301	170	M203160	384	M207720	355	M223563FL	95	M225463MFL	103	M231000	365
M168429	486	M181820	371	M200302	170	M203161	384	M207760	355	M223563MFL	95	M225463WFL	103	M231220	371
M168490	486	M181860	371	M200303	170	M203220	384	M207820	355	M223563SP	95	M225463WFL	103	M231260	371
M168491	486	M182060	144	M200304	171	M203221	384	M207860	355	M223733	95	M225533MFL	103	M231320	371
M168496	486	M182160	144	M200401	170	M203260	384	M207920	355	M223743	95	M225533WFL	103	M231360	371
M168499	486	M182210	145	M200402	170	M203261	384	M207960	355	M223763	95	M225533WFL	103	M231420	371
M168520	483	M182310	145	M200403	170	M203700	331	M211600	380	M224033FL	95	M225543MFL	103	M231460	371
M168521	483	M182410	145	M200404	171	M203800	331	M211700	380	M224033MFL	95	M225543WFL	103	M231520	371
M168526	483	M182510	145	M200501	170	M204000	331	M217300	336	M224033SP	95	M225543WFL	103	M231560	371
M168529	483	M182700	144	M200502	170	M204001	331	M217400	336	M224043FL	95	M225563MFL	103	M231620	371
M168590	483	M182800	144	M200503	170	M204100	331	M217560	344	M224043MFL	95	M225563WFL	103	M231660	371
M168591	483	M183060	145	M200504	171	M204101	331	M217660	334	M224043SP	95	M225563WFL	103	M231720	371
M168596	483	M183160	145	M201501	172	M204200	331	M217760	340	M224063FL	95	M225633MFL	103	M231760	371
M168599	483	M183260	145	M201502	172	M204201	331	M217800	340	M224063MFL	95	M225633WFL	103	M231820	371
M168620	483	M186700	333	M201503	172	M204300	331	M217900	340	M224063SP	95	M225633WFL	103	M231860	371
M168621	483	M186800	338	M201504	173	M204301	331	M219600	344	M224133FL	95	M225643MFL	103	M231920	371
M168626	483	M187300	333	M201601	172	M204800	324	M219700	344	M224133MFL	95	M225643WFL	103	M231960	371
M168629	483	M188100	331	M201602	172	M204900	324	M220000	314	M224133SP	95	M225643WFL	103	M232020	371
M168690	483	M188200	331	M201603	172	M205020	326	M220100	314	M224143FL	95	M225663MFL	103	M232060	371
M168691	483	M188500	335	M201604	173	M205060	326	M220200	314	M224143MFL	95	M225663WFL	103	M232120	371
M168696	483	M188600	335	M201701	172	M205120	326	M220300	314	M224143SP	95	M225663WFL	103	M232160	371
M168699	483	M188820	327	M201702	172	M205160	326	M220400	314	M224163FL	95	M226920	387	M232220	371
M168920	488	M188860	327	M201703	172	M205220	351	M220500	314	M224163MFL	95	M226921	387	M232260	371
M168921	488	M189000	327	M201704	173	M205221	351	M220600	314	M224163SP	95	M226960	387	M232320	371
M168926	488	M189100	327	M201801	172	M205260	351	M220700	314	M224233FL	97	M226961	387	M232360	371
M168990	488	M189200	327	M201802	172	M205261	351	M220800	314	M224233MFL	97	M227020	387	M232400	365
M168991	488	M189300	327	M201803	172	M205320	351	M221000	314	M224233SP	97	M227021	387	M232600	371
M168996	488	M194320	371	M201804	173	M205321	351	M221100	314	M224233WFL	97	M227060	387	M232710	380
M170300	142	M194360	371	M201901	171	M205360	351	M221300	315	M224243FL	97	M227061	387		

M233600	374	M237433	102	M243360	236	M245660	186	M248041	541	M249711	548	M251725	200	M254215	201
M233900	378	M237443	102	M243361	236	M245710	186	M248061	541	M249721	548	M251760	200	M254220	201
M234000	378	M237463	102	M243420	236	M245720	186	M248111	541	M249731	548	M251765	200	M254225	201
M234200FL	378	M237533	102	M243421	236	M245760	186	M248121	541	M249741	548	M251810	200	M254260	201
M234200MFL	378	M237543	102	M243460	236	M245810	186	M248131	541	M249761	548	M251815	200	M254265	201
M234200SP	378	M237563	102	M243461	236	M245820	186	M248141	541	M249811	548	M251820	200	M254310	201
M234400	378	M237633	102	M243520	236	M245860	186	M248161	541	M249821	548	M251825	200	M254315	201
M234500	375	M237643	102	M243521	236	M245910	186	M248211	540	M249831	548	M251860	200	M254320	201
M234600	375	M237663	102	M243560	236	M245920	186	M248221	540	M249841	548	M251865	200	M254325	201
M234700	375	M237733	102	M243561	236	M245960	186	M248231	540	M249861	548	M251910	200	M254360	201
M234800	375	M237743	102	M243633	102	M246010	186	M248241	540	M249911	548	M251915	200	M254365	201
M234900	375	M237763	102	M243643	102	M246020	186	M248261	540	M249921	548	M251920	200	M254410	201
M235000	377	M237800	374	M243663	102	M246060	186	M248311	540	M249931	548	M251925	200	M254415	201
M235100	375	M237801	374	M243733	102	M246110	186	M248321	540	M249941	548	M251960	200	M254420	201
M235200	375	M237900	374	M243743	102	M246120	186	M248331	540	M249961	548	M251965	200	M254425	201
M235300	375	M237901	374	M243763	102	M246160	186	M248341	540	M250011	531	M252010	200	M254460	201
M235400	375	M239200	223	M243833	102	M246210	186	M248361	540	M250021	531	M252015	200	M254465	201
M235500	375	M239300	233	M243843	102	M246220	186	M248411	536	M250031	531	M252020	200	M254510	201
M235620	385	M239400	233	M243863	102	M246260	186	M248421	536	M250041	531	M252025	200	M254515	201
M235621	385	M239500	233	M243933	102	M246310	186	M248431	536	M250111	531	M252060	200	M254520	201
M235660	385	M239600	223	M243943	102	M246320	186	M248441	536	M250121	531	M252065	200	M254525	201
M235661	385	M239700	223	M243963	102	M246360	186	M248461	536	M250131	531	M252110	200	M254560	201
M235720	385	M239820	224	M244020	226	M246410	182	M248511	536	M250141	531	M252115	200	M254565	201
M235721	385	M239920	224	M244021	226	M246420	182	M248521	536	M250211	530	M252120	200	M254600	201
M235760	385	M240100	571	M244060	226	M246460	182	M248531	536	M250221	530	M252125	200	M254605	201
M235761	385	M240101	571	M244061	226	M2464510	182	M248541	536	M250231	530	M252160	200	M254700	201
M235820	385	M240211	550	M244120	226	M246520	182	M248561	536	M250241	530	M252165	200	M254705	201
M235821	385	M240221	550	M244121	226	M246560	182	M248611	536	M250311	530	M252200	200	M254800	201
M235860	385	M240231	550	M244160	226	M246610	182	M248621	536	M250321	530	M252205	200	M254805	201
M235861	385	M240241	550	M244161	226	M246620	182	M248631	536	M250331	530	M252300	200	M254900	201
M235920	385	M240261	550	M244220	226	M246660	182	M248641	536	M250341	530	M252305	200	M254905	201
M235921	385	M240311	550	M244221	226	M246710	182	M248661	536	M250411	526	M252400	200	M255000	201
M235960	385	M240321	550	M244260	226	M246720	182	M248711	536	M250421	526	M252405	200	M255005	201
M235961	385	M240331	550	M244261	226	M246760	182	M248721	536	M250431	526	M252500	200	M255100	201
M236020	385	M240341	550	M244320	226	M246810	182	M248731	536	M250441	526	M252505	200	M255105	201
M236021	385	M240361	550	M244321	226	M246820	182	M248741	536	M250511	526	M252600	200	M255200	201
M236060	385	M240500	224	M244360	226	M246860	182	M248761	536	M250521	526	M252605	200	M255205	201
M236061	385	M240600	222	M244361	226	M246910	182	M248811	552	M250531	526	M252700	200	M255300	201
M236120	385	M240700	234	M244610	534	M246920	182	M248821	552	M250541	526	M252705	200	M255305	201
M236121	385	M240800	234	M244620	534	M246960	182	M248831	552	M250611	526	M252800	200	M255400	201
M236160	385	M241000	234	M244630	534	M247010	182	M248841	552	M250621	526	M252805	200	M255405	201
M236161	385	M241001	234	M244640	534	M247020	182	M248861	552	M250631	526	M252900	200	M255500	201
M236233	96	M241100	234	M244660	534	M247060	182	M248911	552	M250641	526	M252905	200	M255505	201
M236243	96	M241101	234	M244710	534	M247110	182	M248921	552	M250711	526	M253000	200	M255600	201
M236263	96	M241200	234	M244720	534	M247120	182	M248931	552	M250721	526	M253005	200	M255605	201
M236333	96	M241201	234	M244730	534	M247160	182	M248941	552	M250731	526	M253100	200	M255700	201
M236343	96	M241300	234	M244740	534	M247210	184	M248961	552	M250741	526	M253105	200	M255705	201
M236363	96	M241301	234	M244760	534	M247220	184	M249010	524	M250811	552	M253200	200	M255820	204
M236433	96	M241400	232	M244810	534	M247260	184	M249020	524	M250821	552	M253205	200	M255825	204
M236443	96	M241401	232	M244820	534	M247310	184	M249030	524	M250831	552	M253300	200	M255860	204
M236463	96	M241500	232	M244830	534	M247320	184	M249040	524	M250841	552	M253305	200	M255865	204
M236533	96	M241501	232	M244840	534	M247360	184	M249110	524	M250861	552	M253420	201	M255920	204
M236543	96	M241600	232	M244860	534	M247410	184	M249120	524	M250911	552	M253425	201	M255925	204
M236563	96	M241601	232	M244910	534	M247420	184	M249130	524	M250921	552	M253520	201	M255960	204
M236633	96	M241700	232	M244920	534	M247460	184	M249140	524	M250931	552	M253525	201	M255965	204
M236643	96	M241701	232	M244930	534	M247610	546	M249211	550	M250941	552	M253615	201	M256020	204
M236663	96	M242000	224	M244940	534	M247620	546	M249221	550	M250961	552	M253620	201	M256025	204
M236733	96	M242001	224	M244960	534	M247630	546	M249231	550	M251020	200	M253625	201	M256060	204
M236743	96	M242100	224	M245010	186	M247640	546	M249241	550	M251025	200	M253715	201	M256065	204
M236763	96	M242101	224	M245020	186	M247660	546	M249261	550	M251120	200	M253720	201	M256120	204
M236833	96	M242200	224	M245060	186	M247710	546	M249311	550	M251125	200	M253725	201	M256125	204
M236843	96	M242201	224	M245110	186	M247720	546	M249321	550	M251220	200	M253820	201	M256160	204
M236863	96	M242300	224	M245120	186	M247730	546	M249331	550	M251225	200	M253825	201	M256165	204
M236933	96	M242301	224	M245160	186	M247740	546	M249341	550	M251320	200	M253920	201	M256220	204
M236943	96	M242400	222	M245210	186	M247760	546	M249361	550	M251325	200	M253925	201	M256225	204
M236963	96	M242401	222	M245220	186	M247810	546	M249410	524	M251420	200	M254010	201	M256260	204
M237033	96	M242500	222	M245260	186	M247820	546	M249420	524	M251425	200	M254015	201	M256265	204
M237043	96	M242501	222	M245310	186	M247830	546	M249430	524	M251520	200	M254020	201	M256320	204
M237063	96	M242600	222	M245320	186	M247840	546	M249440	524	M251525	200	M254025	201	M256325	204
M237133	96	M242601	222	M245360	186	M247860	546	M249510	524	M251610	200	M254060	201	M256360	204
M237143	96	M242700	222	M245410	186	M247910	546	M249520	524	M251615	200	M254065	201	M256365	204
M237163	96	M242701	222	M245420	186	M247920	546	M249530	524	M251620	200	M254110	201	M256420	204
M237233	96	M243220	236	M245460	186	M247930	546	M249540	524	M251625	200	M254115	201	M256425	204
M237243	96	M243221	236	M245510	186	M247940	546	M249611	548	M251660	200	M254120	201	M256460	204
M237263	96	M243260	236	M245520	186	M247960	546	M249621	548	M251665	200	M254125	201	M256465	204
M237333	96	M243261	236	M245560	186	M248011	541	M249631	548	M251710	200	M254160	201	M256520	204
M237343	96	M243320	236	M245610	186	M248021	541	M249641	548	M251715	200	M254165	201	M256525	204
M237363	96	M243321	236	M245620	186	M248031	541	M249661	548	M251720	200	M254210	201	M256560	204

Codes index

M256565	204	M259805	206	M263165	211	M274025	201	M279025	200	M284420	121	M2889N21	352	M2900W21	386
M256620	204	M259900	206	M263220	211	M274110	201	M279110	200	M284510	121	M2889N60	352	M2900W60	386
M256625	204	M259905	206	M263225	211	M274115	201	M279115	200	M284520	121	M2889N61	352	M2900W61	386
M256660	204	M260000	206	M263260	211	M274120	201	M279120	200	M284610	121	M2889W20	352	M2901N20	386
M256665	204	M260005	206	M263265	211	M274125	201	M279125	200	M284620	121	M2889W21	352	M2901N21	386
M256720	204	M260100	206	M263320	211	M274200	201	M279200	200	M284710	121	M2889W60	352	M2901N60	386
M256725	204	M260105	206	M263325	211	M274205	201	M279205	200	M284720	121	M2889W61	352	M2901N61	386
M256760	204	M260200	206	M263360	211	M274300	201	M279300	200	M285007	123	M2890N20	352	M2901W20	386
M256765	204	M260205	206	M263365	211	M274305	201	M279305	200	M285107	123	M2890N21	352	M2901W21	386
M257000	206	M260300	206	M263420	211	M274400	201	M279400	200	M285207	123	M2890N60	352	M2901W60	386
M257005	206	M260305	206	M263425	211	M274405	201	M279405	200	M285307	127	M2890N61	352	M2901W61	386
M257100	206	M260620	201	M263460	211	M274500	201	M279500	200	M286020	206	M2890W20	352	M2902N20	386
M257105	206	M260625	201	M263465	211	M274505	201	M279505	200	M286060	206	M2890W21	352	M2902N21	386
M257200	206	M260660	201	M263520	211	M274600	201	M279600	200	M286120	206	M2890W60	352	M2902N60	386
M257205	206	M260665	201	M263525	211	M274605	201	M279605	200	M286160	206	M2890W61	352	M2902N61	386
M257300	206	M260720	201	M263560	211	M274700	201	M279700	200	M286220	213	M2891W20	352	M2902W20	386
M257305	206	M260725	201	M263565	211	M274705	201	M279705	200	M286260	213	M2891N21	352	M2902W21	386
M257400	206	M260760	201	M263620	211	M274800	212	M280015	128	M286320	213	M2891N60	352	M2902W60	386
M257405	206	M260765	201	M263625	211	M274900	212	M280025	128	M286360	213	M2891N61	352	M2902W61	386
M257500	206	M260820	201	M263660	211	M275615	122	M280115	128	M2864W21	134	M2891W20	352	M2903N20	386
M257505	206	M260825	201	M263665	211	M275625	122	M280125	128	M2865W21	134	M2891W21	352	M2903N21	386
M257600	206	M260860	201	M263720	211	M275715	122	M280215	128	M2866W21	134	M2891W60	352	M2903N60	386
M257605	206	M260865	201	M263725	211	M275725	122	M280225	128	M2867W21	134	M2891W61	352	M2903N61	386
M257700	206	M260920	201	M263760	211	M276015	122	M280315	128	M2868W21	134	M2892N20	353	M2903W20	386
M257705	206	M260925	201	M263765	211	M276025	122	M280325	128	M2869W21	134	M2892N21	353	M2903W21	386
M257800	206	M260960	201	M264020	211	M276115	122	M280415	128	M2870W21	135	M2892N60	353	M2903W60	386
M257805	206	M260965	201	M264025	211	M276125	122	M280425	128	M2871W21	135	M2892N61	353	M2903W61	386
M257900	206	M261020	201	M264060	211	M276215	126	M280515	128	M2872W21	135	M2892W20	353	M2904N20	386
M257905	206	M261025	201	M264065	211	M276225	126	M280525	128	M2873W01	134	M2892W21	353	M2904N21	386
M258220	205	M261060	201	M264120	211	M276315	126	M280615	130	M2827W01	134	M2892W60	353	M2904N60	386
M258225	205	M261065	201	M264125	211	M276325	126	M280625	130	M2875W01	134	M2892W61	353	M2904N61	386
M258260	205	M261120	201	M264160	211	M276415	126	M280715	130	M2876W01	134	M2893N20	353	M2904W20	386
M258265	205	M261125	201	M264165	211	M276425	126	M280725	130	M2877W01	134	M2893N21	353	M2904W21	386
M258320	205	M261160	201	M264200	212	M276515	126	M280815	130	M2878W01	134	M2893N60	353	M2904W60	386
M258325	205	M261165	201	M264205	212	M276525	126	M280825	130	M2879W01	135	M2893N61	353	M2904W61	386
M258360	205	M261220	201	M264300	212	M277215	124	M280900	120	M2880W01	135	M2893W20	353	M2905N20	386
M258365	205	M261225	201	M264305	212	M277225	124	M281000	120	M2881W01	135	M2893W21	353	M2905N21	386
M258420	205	M261260	201	M264400	212	M277415	124	M281735	123	M2882N00	333	M2893W60	353	M2905N60	386
M258425	205	M261265	201	M264405	212	M277425	124	M281745	123	M2882N01	333	M2893W61	353	M2905N61	386
M258460	205	M261320	201	M264500	212	M277515	124	M281755	123	M2882W00	333	M2894N20	353	M2905W20	386
M258465	205	M261325	201	M264505	212	M277525	124	M281807	125	M2882W01	333	M2894N21	353	M2905W21	386
M258520	205	M261360	201	M264600	212	M277615	124	M281907	125	M2883N00	333	M2894N60	353	M2905W60	386
M258525	205	M261365	201	M264605	212	M277625	124	M282007	125	M2883N01	333	M2894N61	353	M2905W61	386
M258560	205	M261620	201	M264700	212	M277815	124	M282100	125	M2883W00	333	M2894W20	353	M3000N61	434
M258565	205	M261625	201	M264705	212	M277825	124	M282235	127	M2883W01	333	M2894W21	353	M3000W61	434
M258620	205	M261660	201	M264800	212	M277915	124	M282307	129	M2884N00	333	M2894W60	353	M3001N61	430
M258625	205	M261665	201	M264805	212	M277925	124	M282407	129	M2884N01	333	M2894W61	353	M3001W61	430
M258660	205	M261720	201	M264900	212	M278033	100	M282710	120	M2884W00	333	M2894W20	353	M3002N61	434
M258665	205	M261725	201	M264905	212	M278043	100	M282720	120	M2884W01	333	M2895N21	353	M3002W61	434
M258720	205	M261760	201	M265000	212	M278063	100	M282730	120	M2885N00	333	M2895N60	353	M3003N61	430
M258725	205	M261765	201	M265005	212	M278133	100	M282750	120	M2885N01	333	M2895N61	353	M3003W61	430
M258760	205	M261800	212	M265100	212	M278143	100	M282810	120	M2885W00	333	M2895W20	353	M3004N61	430
M258765	205	M261805	212	M265105	212	M278163	100	M282820	120	M2885W01	333	M2895W21	353	M3004W61	430
M258820	205	M261900	212	M265200	212	M278233	100	M282830	120	M2886N20	352	M2895W60	353	M3005Y1	431
M258825	205	M261905	212	M265205	212	M278243	100	M282850	120	M2886N21	352	M2895W61	353	M300691	431
M258860	205	M262000	212	M265300	212	M278263	100	M282910	120	M2886N60	352	M2896N20	353	M300791	431
M258865	205	M262005	212	M265305	212	M278333	100	M282920	120	M2886N61	352	M2896N21	353	M300891	431
M258920	205	M262100	212	M273400	206	M278343	100	M282930	120	M2886W20	352	M2896N60	353	M300900	435
M258925	205	M262105	212	M273500	206	M278363	100	M282950	120	M2886W21	352	M2896N61	353	M301000	435
M258960	205	M262200	212	M273610	201	M278610	200	M283110	120	M2886W60	352	M2896W20	353	M301010	435
M258965	205	M262205	212	M273615	201	M278615	200	M283120	120	M2886W61	352	M2896W21	353	M301020	435
M259020	205	M262300	212	M273620	201	M278620	200	M283130	120	M2887N20	352	M2896W60	353	M301030	435
M259025	205	M262305	212	M273625	201	M278625	200	M283150	120	M2887N21	352	M2896W61	353	M301040	435
M259060	205	M262400	212	M273710	201	M278710	200	M283210	120	M2887N60	352	M2897N20	353	M301050	435
M259065	205	M262405	212	M273715	201	M278715	200	M283220	120	M2887N61	352	M2897N21	353	M301100	431
M259120	205	M262500	212	M273720	201	M278720	200	M283230	120	M2887W20	352	M2897N60	353	M301110	431
M259125	205	M262505	212	M273725	201	M278725	200	M283250	120	M2887W21	352	M2897N61	353	M301120	431
M259160	205	M262600	212	M273810	201	M278810	200	M283310	120	M2887W60	352	M2897W20	353	M301130	431
M259165	205	M262605	212	M273815	201	M278815	200	M283320	120	M2887W61	352	M2897W21	353	M301140	431
M259400	206	M262700	212	M273820	201	M278820	200	M283330	120	M2888N20	352	M2897W60	353	M301150	431
M259405	206	M262705	212	M273825	201	M278825	200	M283350	120	M2888N21	352	M2897W61	353	M301200	431
M259500	206	M263020	211	M273910	201	M278910	200	M284110	121	M2888N60	352	M289800	376	M301210	431
M259505	206	M263025	211	M273915	201	M278915	200	M284120	121	M2888N61	352	M289900	376	M301220	431
M259600	206	M263060	211	M273920	201	M278920	200	M284210	121	M2888W20	352	M2900N20	386	M301230	431
M259605	206	M263065	211	M273925	201	M278925	200	M284220	121	M2888W21	352	M2900N21	386	M301240	431
M259700	206	M263120	211	M274010	201	M279010	200	M284310	121	M2888W60	352	M2900N60	386	M301250	431
M259705	206	M263125	211	M274015	201	M279015	200	M284320	121	M2888W61	352	M2900N61	386	M301300	431
M259800	206	M263160</													

M301320	431	M3105W51	407	NL17032VTW1	653	NL1708625K006	283	NL17331ELKO	643	NL18001	881	NL1906460Y004	250	NL1907240W004	252
M301330	431	M3105W91	407	NL170330	653	NL1708625W002	283	NL17331ELW0	643	NL19003	881	NL1906460Y006	250	NL1907240W006	252
M301340	431	M3106N21	409	NL17034VTK0	653	NL1708625W003	283	NL1733210K0	643	NL19004	881	NL1906480K002	250	NL1907240Y002	252
M301350	431	M3106N51	409	NL17034VTK1	653	NL1708625W004	283	NL1733210W0	643	NL19005	881	NL1906480K004	250	NL1907240Y004	252
M301400	431	M3106N91	409	NL17034VTW0	653	NL1708625W006	283	NL1733225K0	643	NL19006	881	NL1906480K006	250	NL1907240Y006	252
M301410	431	M3106W21	409	NL17034VTW1	653	NL1708710K002	283	NL1733225W0	643	NL19007	881	NL1906480W002	250	NL1907260K002	252
M301420	431	M3106W51	409	NL17036	653	NL1708710K003	283	NL173322ELK0	643	NL19008	880	NL1906480W004	250	NL1907260K004	252
M301430	431	M3106W91	409	NL17037	653	NL1708710K006	283	NL17332ELW0	643	NL19009	880	NL1906480W006	250	NL1907260K006	252
M301440	431	M3107N21	409	NL1707110K0	627	NL1708710W002	283	NL1733310K0	643	NL19010	880	NL1906480Y002	250	NL1907260W002	252
M301450	431	M3107N51	409	NL1707110W0	627	NL1708710W003	283	NL1733310W0	643	NL19011	880	NL1906480Y004	250	NL1907260W004	252
M301500	431	M3107N91	409	NL1707125K0	627	NL1708710W006	283	NL1733325K0	643	NL19012	880	NL1906480Y006	250	NL1907260W006	252
M301600	435	M3107W21	409	NL1707125W0	627	NL1708725K002	283	NL1733325W0	643	NL19013	881	NL1906840K002	248	NL1907260Y002	252
M301610	435	M3107W51	409	NL17071ELK0	627	NL1708725K003	283	NL17333ELK0	643	NL19014	881	NL1906840K004	248	NL1907260Y004	252
M301620	435	M3107W91	407	NL17071ELW0	627	NL1708725K006	283	NL17333ELW0	643	NL19015	881	NL1906840K006	248	NL1907260Y006	252
M301630	435	M310820	407	NL1707210K0	627	NL1708725W002	283	NL1734010K004	290	NL19016	881	NL1906840W002	248	NL1907280K002	252
M301640	435	M310850	407	NL1707210W0	627	NL1708725W003	283	NL1734010K006	290	NL19017	881	NL1906840W004	248	NL1907280K004	252
M301650	435	M310890	407	NL1707225K0	627	NL1708725W006	283	NL1734010W004	290	NL19018	881	NL1906840W006	248	NL1907280K006	252
M3050N21	417	M310920	409	NL1707225W0	627	NL17088K0	286	NL1734010W006	290	NL19019	874	NL1906860K002	248	NL1907280W002	252
M3050N61	417	M310950	409	NL17072ELK0	627	NL17088W0	286	NL1734110K004	294	NL19024	740	NL1906860K004	248	NL1907280W004	252
M3050W21	417	M310990	409	NL17072ELW0	627	NL17089K0	286	NL1734110K006	294	NL19027	736	NL1906860K006	248	NL1907280W006	252
M3050W61	417	M3200N21	440	NL1707510C	627	NL17089W0	286	NL1734110W004	294	NL19028	657	NL1906860W002	248	NL1907280Y002	252
M3051N21	416	M3200N31	440	NL1707525C	627	NL17090K0	286	NL1734110W006	294	NL19029	657	NL1906860W004	248	NL1907280Y004	252
M3051N61	416	M3200N41	440	NL17075ELC	627	NL17090W0	286	NL1734210K004	295	NL19030	878	NL1906860W006	248	NL1907280Y006	252
M3051W21	416	M3200N61	440	NL1708110K002	281	NL17091K0	286	NL1734210K006	295	NL19031	878	NL1906940K002	248	NL1907340K002	252
M3051W61	416	M3200W21	440	NL1708110K003	281	NL17091W0	286	NL1734210W004	295	NL19032	740	NL1906940K004	248	NL1907340K004	252
M305220	416	M3200W31	440	NL1708110K006	281	NL17092K0	287	NL1734210W006	295	NL19034	874	NL1906940K006	248	NL1907340K006	252
M305260	416	M3200W41	440	NL1708110W002	281	NL17092W0	287	NL17345H004	295	NL19035	740	NL1906940W002	248	NL1907340W002	252
M305320	416	M3200W61	440	NL1708110W003	281	NL17093K0	287	NL17346H004	294	NL19036	740	NL1906940W004	248	NL1907340W004	252
M305360	416	M3201N21	440	NL1708110W006	281	NL17093W0	287	NL17346H006	294	NL19040	627	NL1906940W006	248	NL1907340W006	252
M305420	416	M3201N31	440	NL1708125K002	281	NL17212VTK0	256	NL1735010K004	290	NL19041	874	NL1906960K002	248	NL1907360W002	252
M305460	416	M3201N41	440	NL1708125K003	281	NL17212VTW0	256	NL1735010K006	290	NL19046	700	NL1906960K004	248	NL1907340Y004	252
M305521	416	M3201N61	440	NL1708125K006	281	NL17213VTK0	256	NL1735010W004	290	NL19047	700	NL1906960K006	248	NL1907340Y006	252
M305621	416	M3201W21	440	NL1708125W002	281	NL17213VTW0	256	NL1735010W006	290	NL19050	879	NL1906960W002	248	NL1907360Y002	252
M305721	416	M3201W31	440	NL1708125W003	281	NL17214VTK0	256	NL1735110K004	294	NL19051	879	NL1906960W004	248	NL1907360K004	252
M305821	416	M3201W41	440	NL1708125W006	281	NL17214VTW0	256	NL1735110K006	294	NL19052	634	NL1906960W006	248	NL1907360K006	252
M305921	416	M3201W61	440	NL1708310K002	282	NL17215VTK0	256	NL1735110W004	294	NL1906340K002	250	NL1907040K002	248	NL1907360W002	252
M3072W00	395	M3202N21	440	NL1708310K003	282	NL17215VTW0	256	NL1735110W006	294	NL1906340K004	250	NL1907040K004	248	NL1907360W004	252
M3072W20	395	M3202N31	440	NL1708310K006	282	NL17216VTK0	256	NL1735210K004	295	NL1906340K006	250	NL1907040K006	248	NL1907360W006	252
M3075W00	394	M3202N41	440	NL1708310W002	282	NL17216VTW0	256	NL1735210K006	295	NL1906340W002	250	NL1907040W002	248	NL1907360Y002	252
M3075W20	394	M3202N61	440	NL1708310W003	282	NL17217VTK0	256	NL1735210W004	295	NL1906340W004	250	NL1907040W004	248	NL1907360Y004	252
M3082W00	395	M3202W21	440	NL1708310W006	282	NL17217VTW0	256	NL1735210W006	295	NL1906340W006	250	NL1907040W006	248	NL1907360Y006	252
M3082W20	395	M3202W31	440	NL1708325K002	282	NL1732010K0	642	NL1736218K004	291	NL1906340Y002	250	NL1907060K002	248	NL1907380K002	252
M3085W00	394	M3202W41	440	NL1708325K003	282	NL1732010W0	642	NL1736218K006	291	NL1906340Y004	250	NL1907060K004	248	NL1907380K004	252
M3085W20	394	M3202W61	440	NL1708325K006	282	NL1732025K0	642	NL1736218W004	291	NL1906340Y006	250	NL1907060K006	248	NL1907380K006	252
M3100N21	406	M3203N21	441	NL1708325W002	282	NL1732025W0	642	NL1736218W006	291	NL1906360K002	250	NL1907060W002	248	NL1907380W002	252
M3100N51	406	M3203N31	441	NL1708325W003	282	NL17320ELK0	642	NL1736234K004	291	NL1906360K004	250	NL1907060W004	248	NL1907380W004	252
M3100N91	406	M3203N41	441	NL1708325W006	282	NL17320ELW0	642	NL1736234K006	291	NL1906360K006	250	NL1907060W006	248	NL1907380W006	252
M3100W21	406	M3204N61	441	NL1708410K002	281	NL1732110K0	642	NL1736234W004	291	NL1906360W002	250	NL1907060W002	248	NL1907380Y002	252
M3100W51	406	M3204W21	441	NL1708410K003	281	NL1732110W0	642	NL1736234W006	291	NL1906360W004	250	NL1907140K004	250	NL1907380Y004	252
M3100W91	406	M3204W31	441	NL1708410K006	281	NL1732125K0	642	NL1736318K004	291	NL1906360W006	250	NL1907140K006	250	NL1907380Y006	252
M3101N21	406	M3204W41	441	NL1708410W002	281	NL1732125W0	642	NL1736318K006	291	NL1906360Y002	250	NL1907140K002	250	NL1907440K002	252
M3101N51	406	M3203W61	441	NL1708410W003	281	NL17321ELK0	642	NL1736318W004	291	NL1906360Y004	250	NL1907140W004	250	NL1907440K004	252
M3101N91	406	M3204N21	441	NL1708410W006	281	NL17321ELW0	642	NL1736318W006	291	NL1906360Y006	250	NL1907140W006	250	NL1907440K006	252
M3101W21	406	M3204N31	441	NL1708425K002	281	NL1732210K0	642	NL1736334K004	291	NL1906380K002	250	NL1907140Y002	250	NL1907440W002	252
M3101W51	406	M3204N41	441	NL1708425K003	281	NL1732210W0	642	NL1736334K006	291	NL1906380K004	250	NL1907140Y004	250	NL1907440Y004	252
M3101W91	406	M3204N61	441	NL1708425K006	281	NL1732225K0	642	NL1736334W004	291	NL1906380K006	250	NL1907140Y006	250	NL1907440Y006	252
M3102N21	408	M3204W21	441	NL1708425W002	281	NL1732225W0	642	NL1736334W006	291	NL1906380W002	250	NL1907160K002	250	NL1907440Y002	252
M3102N51	408	M3204W31	441	NL1708425W003	281	NL17322ELK0	642	NL17400VTK0	650	NL1906380W004	250	NL1907160K004	250	NL1907440Y004	252
M3102N91	408	M3204W41	441	NL1708425W006	281	NL17322ELW0	642	NL17400VTW0	650	NL1906380W006	250	NL1907160K006	250	NL1907440Y006	252
M3102W21	408	M3204W61	441	NL1708510K002	282	NL1732310K0	642	NL17401VTK0	650	NL1906380Y002	250	NL1907160W002	250	NL1907460K002	252
M3102W51	408	NL10763	880	NL1708510K003	282	NL1732310W0	642	NL17401VTW0	650	NL1906380Y004	250	NL1907160W004	250	NL1907460K004	252
M3102W91	408	NL10941	282	NL1708510K006	282	NL1732325K0	642	NL17402VTK0	650	NL1906380Y006	250	NL1907160W006	250	NL1907460K006	252
M3103N21	408	NL10964	755	NL1708510W002	282	NL1732325W0	642	NL17402VTW0	650	NL1906440K002	250	NL1907160Y002	250	NL1907460W002	252
M3103N51	408	NL11022	874	NL1708510W003	282	NL17323ELK0	642	NL17405VTK0	650	NL1906440K004	250	NL1907160Y004	250	NL1907460W004	252
M3103N91	408	NL11027	676	NL1708525K002	282	NL17323ELW0	642	NL17405VTW0	650	NL1906440K006	250	NL1907160Y006	250	NL1907460W006	252
M3103W21	408	NL11035	134	NL1708525K003	282	NL17325H0	642	NL17406VTK0	650	NL1906440W002	250	NL1907180K002	250	NL1907460Y002	252
M31															

Codes index

NL19081	878	NL3200650W0	602	NL4203518W002	198	NL5003130C002	625	NL730720W0	606	T082000	809	T40001SPW00	714	T40019NSPW00	723
NL19083	878	NL3200750W0	602	NL4203518W004	198	NL5003140C002	625	NL730850K0	606	T082010	809	T40001WFLN00	714	T40019WFLN00	723
NL19084	653	NL32010	601	NL4203518W006	198	NL50031ELC002	625	NL730850W0	606	T082100	808	T40001WFLW00	714	T40019WFLW00	723
NL19090	881	NL32011	601	NL4203534K002	198	NL50035	663	NL730930B0	606	T082110	808	T40002ELPTN00	715	T4001ELPTN00	714
NL19096	881	NL398002	585	NL4203534K004	198	NL50037VTKO	651	NL731030G0	606	T082200	808	T40002ELPTW00	715	T4001ELPTW00	714
NL19096	881	NL398102	585	NL4203534K006	198	NL50037VTW0	651	NL731130R0	606	T082210	808	T400025PN00	715	T40015PN00	714
NL19097	881	NL40021H0	714	NL4203534W002	198	NL50038VTK0	651	NL73130	607	T082300	808	T400025PW00	715	T40015PW00	714
NL19097	881	NL40023H0	718	NL4203534W004	198	NL50038VTV0	651	NL73140	607	T082310	808	T40002WFLN00	715	T4001WFLN00	714
NL3000010K002	673	NL40024H0	719	NL4203534W006	198	NL50039VTKO	651	NL7398VSK0	634	T082400	809	T40002WFLW00	715	T4001WFLW00	714
NL3000010K005	673	NL40025H0	718	NL42036VSK0	736	NL50039VTW0	651	NL7398VSW0	634	T082410	809	T40003ELPTN00	715	T40020ELPTN00	723
NL3000010W002	673	NL40026H0	719	NL42036VSW0	736	NL50040VTK0	651	NL7419VSK0	634	T082600	839	T40003ELPTW00	715	T40020ELPTW00	723
NL3000010W005	673	NL40027H0	722	NL42037VSK0	736	NL50040VTW0	651	NL7419VSW0	634	T082800	786	T400035PN00	715	T40020NSPN00	723
NL3000039K002	673	NL40028H0	723	NL42037VSW0	736	NL50041VTKO	651	NL74890	634	T082810	786	T400035PW00	715	T40020NSPW00	723
NL3000039K005	673	NL40029H0	722	NL42039	737	NL50041VTW0	651	NL75130	878	T082900	785	T40003WFLN00	715	T40020WFLN00	723
NL3000039W002	673	NL40030H0	723	NL42040H0	736	NL50042VTKO	651	NL75190	607	T082910	785	T40003WFLW00	715	T40020WFLW00	723
NL3000039W005	673	NL4203010K002	197	NL4204118K002	198	NL50042VTW0	651	NL75200	607	T083000	825	T40004ELPTN00	716	T4002ELPTN00	715
NL30000ELK002	673	NL4203010K004	197	NL4204118K004	198	NL50044	651	NL75210	607	T083100	825	T40004ELPTW00	716	T4002ELPTW00	715
NL30000ELK005	673	NL4203010K006	197	NL4204118K006	198	NL50045	651	NL75320	645	T083400	796	T40004FLN00	716	T40025PN00	715
NL30000ELW002	673	NL4203025W0004	197	NL4204118W002	198	NL50046	651	NL75321	645	T083500	796	T40005ELPTW00	716	T40025PW00	715
NL30000ELW005	673	NL4203010W004	197	NL4204118W004	198	NL50048	651	NL75340	645	T083510	796	T40004FLW00	716	T4002WFLN00	715
NL3000110K002	673	NL4203010W006	197	NL4204118W006	198	NL50049	651	NL75341	645	T083600	796	T400045PN00	716	T4002WFLW00	715
NL3000110K005	673	NL4203025K002	197	NL4204134K002	198	NL50054	754	NL75390	645	T083610	796	T400045PW00	716	T4003ELPTW00	717
NL3000110W002	673	NL4203025K004	197	NL4204134K004	198	NL5040002	585	NL756510C0	630	T083700	796	T40005ELPTW00	716	T4003FLN00	717
NL3000110W005	673	NL4203025K006	197	NL4204134K006	198	NL504102	585	NL756525C0	630	T083710	796	T40005FLN00	716	T4003FLW00	717
NL3000139K002	673	NL4203025W002	197	NL4204134W002	198	NL58960	881	NL756540C0	630	T083800	797	T40005FLW00	716	T40035PN00	717
NL3000139K005	673	NL4203025W004	197	NL4204134W004	198	NL58980	881	NL756610C0	630	T083810	797	T40005FLW00	716	T40035PW00	717
NL3000139W002	673	NL4203025W006	197	NL4204134W006	198	NL59240	880	NL756625C0	630	T083900	797	T400055PN00	716	T4004ELPTN00	716
NL3000139W005	673	NL4203110K002	197	NL4204218K002	198	NL59250	880	NL756640C0	630	T083910	797	T400055PW00	716	T4004ELPTW00	716
NL30001ELK002	673	NL4203110K004	197	NL4204218K004	198	NL6203	736	NL75810	630	T084800	846	T40006ELPTW00	717	T4004FLN00	716
NL30001ELK005	673	NL4203110K006	197	NL4204218K006	198	NL62040	624	NL76480	635	T085000	817	T40006FLN00	717	T4004FLW00	716
NL30001ELW002	673	NL4203110W002	197	NL4204218W002	198	NL62810	248	NL76490	635	T085100	817	T40006FLW00	717	T40045PN00	716
NL30001ELW005	673	NL4203110W004	197	NL4204218W004	198	NL62880	663	NL76670	634	T085200	859	T400065PN00	717	T40045PW00	716
NL31008	256	NL4203110W006	197	NL4204218W006	198	NL702910K0	657	NL76680	630	T085300	815	T400065PW00	717	T4006ELPTN00	718
NL31009	256	NL4203125K002	197	NL4204234K002	198	NL702910W0	657	NL77270	879	T085400	859	T40007ELPTN00	717	T4006ELPTW00	718
NL31013VTK002	740	NL4203125K004	197	NL4204234K004	198	NL702925K0	657	NL78070	879	T085500	859	T40007ELPTW00	717	T4006NSPN00	718
NL31013VTK004	740	NL4203125K006	197	NL4204234K006	198	NL702925W0	657	NL80210	879	T085600	859	T40007FLN00	717	T4006NSPW00	718
NL31013VTW002	740	NL4203125W002	197	NL4204234W002	198	NL7029ELK0	657	NL80220	879	T085700	843	T40007FLW00	717	T4006WFLN00	718
NL31013VTW004	740	NL4203125W004	197	NL4204234W004	198	NL7029ELW0	657	NL80510	879	T085800	843	T400075PN00	717	T4006WFLW00	718
NL31013VTW006	740	NL4203125W006	197	NL4204234W006	198	NL7043002	256	NL81260	879	T085900	843	T400075PW00	717	T4009ELPTN00	719
NL31013VTW008	740	NL4203218K002	198	NL4591020	585	NL7043006	256	NL81910	879	T087100	783	T40010ELPTN00	718	T4009ELPTW00	719
NL31014H0	740	NL4203218K004	198	NL4591120	585	NL7044002	256	NL82030	607	T087300	830	T40010ELPTW00	718	T4009NSPN00	719
NL31015VTK002	740	NL4203218K006	198	NL50014VSK004	754	NL7044006	256	NL84070	881	T087400	830	T40010NSPN00	718	T4009NSPW00	719
NL31015VTK004	740	NL4203218W002	198	NL50014VSK006	754	NL704750K0	645	NL84100	851	T087500	831	T40010NSPW00	718	T4009WFLN00	719
NL31015VTK006	740	NL4203218W004	198	NL50014VSW004	754	NL704750K1	645	NL86610	650	T087700	830	T40010WFLN00	718	T4009WFLW00	719
NL31015VTK008	740	NL4203218W006	198	NL50014VSW006	754	NL704750T0	645	NL8711	653	T087800	830	T40010WFLW00	718	T4018ELPTN00	720
NL31015VTW004	740	NL4203234K002	198	NL50015VSK004	754	NL704750T1	645	NL87770	645	T277630	772	T40011ELPTN00	718	T4018ELPTW00	720
NL31015VTW006	740	NL4203234K004	198	NL50015VSK006	754	NL704850K0	645	NL88520	650	T277690	772	T40011ELPTW00	718	T4018NSPN00	720
NL31015VTW008	740	NL4203234K006	198	NL50015VSW004	754	NL704850K1	645	NL88690	645	T277730	772	T40011NSPN00	718	T4018NSPW00	720
NL31016VTK004	740	NL4203234W002	198	NL50015VSW006	754	NL704850T0	645	NL89080	651	T277790	772	T40011NSPW00	718	T4018WFLN00	720
NL31016VTK006	740	NL4203234W004	198	NL50016VSK004	755	NL704850T1	645	NL89090	650	T2778130	772	T40011WFLN00	718	T4018WFLW00	720
NL31016VTK008	740	NL4203234W006	198	NL50016VSK006	755	NL708610K0	281	NL91750	657	T2778190	772	T40011WFLW00	718	T4031ELPTN00	714
NL31016VTW004	740	NL4203318K002	198	NL50016VSW004	755	NL708610W0	281	NL99490	645	T277830	772	T40014ELPTN00	719	T4031ELPTW00	714
NL31016VTW006	740	NL4203318K004	198	NL50016VSW006	755	NL7146002	256	T052010	791	T277890	772	T40014ELPTW00	719	T40315PN00	714
NL31016VTW008	740	NL4203318K006	198	NL50017VSK004	755	NL7146006	256	T052210	783	T2779130	772	T40014NSPN00	719	T40315PW00	714
NL31017VTK004	740	NL4203318W002	198	NL50017VSK006	755	NL7147002	256	T052290	783	T2779190	772	T40014NSPW00	719	T4031WFLN00	714
NL31017VTK006	740	NL4203318W004	198	NL50017VSW004	755	NL7147006	256	T052310	783	T277930	772	T40014WFLN00	719	T4031WFLW00	714
NL31017VTK008	740	NL4203318W006	198	NL50017VSW006	755	NL716610K0	630	T052390	783	T277990	772	T40014WFLW00	719	T4032ELPTN00	715
NL31017VTW004	740	NL4203334K002	198	NL50018H0	754	NL716610W0	630	T053010	791	T2780130	772	T40015ELPTN00	719	T4032ELPTW00	715
NL31017VTW006	740	NL4203334K004	198	NL50019H0	754	NL716625K0	630	T053110	791	T2780190	772	T40015ELPTW00	719	T40325PN00	715
NL31017VTW008	740	NL4203334K006	198	NL50020H0	754	NL716625W0	630	T053710	791	T278030	772	T40015NSPN00	719	T40325PW00	715
NL31018VTK004	740	NL4203334W002	198	NL50021H0	754	NL716640K0	630	T053810	791	T278090	772	T40015NSPW00	719	T4032WFLN00	715
NL31018VTK006	740	NL4203334W004	198	NL50022H0	755	NL716640W0	630	T053900	791	T2781130	772	T40015NSPW00	719	T4032WFLW00	715
NL31018VTK008	740	NL4203334W006	198	NL50023H0	755	NL716710K0	630	T081000	802	T2781190	772	T40015SWFLW00	719	T4033ELPTN00	717
NL31018VTW004	740	NL4203418K002	198	NL50024	754	NL716710W0	630	T081010	802	T278130	772	T40017ELPTN00	722	T4033ELPTW00	717
NL31018VTW006	740	NL4203418K004	198	NL50025004	754	NL716725K0	630	T081100	802	T278190	772	T40017ELPTW00	722	T4033FLN00	717
NL31019VTK002	740	NL4203418K006	198	NL50025006	754	NL716725W0	630	T081110	802	T278230	773	T40017NSPN00	722	T4033FLW00	717
NL31019VTK004	740	NL4203418W002	198	NL50026VSK004	754	NL716740K0	630	T081200	803	T278290	773	T40017NSPW00	722	T40335PN00	716
NL31019VTK006	740	NL4203418W004	198	NL50026VSK006	754	NL716740W0	630	T081210	803	T278330	773	T40017WFLN00	722	T40335PW00	717
NL31019VTK008	740	NL4													

T4036NSPW00	718	T4080SPW00	696	T409917	708	T4134NSPN00	709	T4184ELN00	681	T42002WFLW00	697	T42013ELPTW00	700	T4211NLW10	762
T4036WFLN00	718	T4080WFLN00	696	T409918	708	T4134NSPW00	709	T418610N00	679	T42003ELPTN00	698	T42013NSPN00	700	T42121LN00	762
T4036WFLW00	718	T4080WFLW00	696	T409919	707	T4134WFLN00	709	T418610W00	679	T42003ELPTW00	698	T42013NSPW00	700	T42121LN10	762
T4039ELPTN00	719	T4081ELPTN00	696	T409920	707	T4134WFLW00	709	T418620N00	679	T42003FLN00	698	T42013WFLN00	700	T42121LW00	762
T4039ELPTW00	719	T4081ELPTW00	696	T409921	744	T415000N00	730	T418620W00	679	T42003FLW00	698	T42013WFLW00	700	T42121LW10	762
T4039NSPN00	719	T4081SPN00	696	T409922	744	T415000W00	730	T418640N00	679	T42003SPN00	698	T42014ELPTN00	701	T42121NN00	762
T4039NSPW00	719	T4081SPW00	696	T409923	744	T415100N00	730	T418640W00	679	T42003SPW00	698	T42014ELPTW00	701	T42121NN10	762
T4039WFLN00	719	T4081WFLN00	696	T409996	831	T415100W00	730	T418710N00	679	T42004ELPTN00	699	T42014NSPN00	701	T42121NW00	762
T4039WFLW00	719	T4081WFLW00	696	T409998	831	T415200N00	730	T418710W00	679	T42004ELPTW00	699	T42014NSPW00	701	T42121NW10	762
T4048ELPTN00	720	T4082ELPTN00	698	T409999	830	T415200W00	730	T418720N00	679	T42004FLN00	699	T42014WFLN00	701	T430010N00	624
T4048ELPTW00	720	T4082ELPTW00	698	T4100ELPTN00	722	T415300N00	730	T418720W00	679	T42004FLW00	699	T42014WFLW00	701	T430010W00	624
T4048NSPN00	720	T4082FLN00	698	T4100ELPTW00	722	T415300W00	730	T418740N00	679	T42004LN00	763	T42015ELPTN00	702	T430025N00	624
T4048NSPW00	720	T4082FLW00	698	T4100NSPN00	722	T415400N00	731	T418740W00	679	T42004LN10	763	T42015ELPTW00	702	T430025W00	624
T4048WFLN00	720	T4082SPN00	698	T4100NSPW00	722	T415400W00	731	T418810N00	667	T42004LW00	763	T42015NSPN00	702	T4300ELN00	624
T4048WFLW00	720	T4082SPW00	698	T4100WFLN00	722	T415500N00	731	T418810N10	667	T42004LW10	763	T42015NSPW00	702	T4300ELW00	624
T4060ELPTN00	697	T4083ELPTN00	698	T4100WFLW00	722	T415500W00	731	T418810W00	667	T42004NN00	763	T42015WFLN00	702	T43010N00	624
T4060ELPTW00	697	T4083ELPTW00	698	T4101ELPTN00	723	T415600N00	731	T418810W10	667	T42004NN10	763	T42015WFLW00	702	T430110W00	624
T4060SPN00	697	T4083FLN00	698	T4101ELPTW00	723	T415600W00	731	T418839N00	667	T42004NW00	763	T42016ELPTN00	703	T430125N00	624
T4060SPW00	697	T4083FLW00	698	T4101NSPN00	723	T415700N00	730	T418839N10	667	T42004NW10	763	T42016ELPTW00	703	T430125W00	624
T4060WFLN00	697	T4083FLW00	698	T4101NSPW00	723	T415700W00	730	T418839W00	667	T42004SPN00	699	T42016NSPN00	703	T4301ELN00	624
T4060WFLW00	697	T4083FLW00	698	T4101WFLN00	723	T415800N00	732	T418839W10	667	T42004SPW00	699	T42016NSPW00	703	T4301ELW00	624
T4061ELPTN00	697	T4083SPN00	698	T4101WFLW00	723	T415800W00	732	T4188ELN00	667	T42005ELPTN00	700	T42016WFLN00	703	T430210N00	624
T4061ELPTW00	697	T4083SPW00	698	T4104ELPTN00	724	T415900N00	732	T4188ELN10	667	T42005ELPTW00	700	T42016WFLW00	703	T430210W00	624
T4061SPN00	697	T4084ELPTN00	700	T4104ELPTW00	724	T415900W00	732	T4188ELW00	667	T42005NSPN00	700	T42017ELPTN00	707	T430225N00	624
T4061SPW00	697	T4084ELPTW00	700	T4104NSPN00	724	T416000N00	732	T4188ELW10	667	T42005NSPW00	700	T42017ELPTW00	707	T430225W00	624
T4061WFLN00	697	T4084NSPN00	700	T4104NSPW00	724	T416000W00	732	T418910N00	666	T42005WFLN00	700	T42017NSPN00	707	T4302ELN00	624
T4061WFLW00	697	T4084NSPW00	700	T4104WFLN00	724	T416100N00	732	T418910N10	666	T42005WFLW00	700	T42017NSPW00	707	T4302ELW00	624
T4062ELPTN00	699	T4084WFLN00	700	T4104WFLW00	724	T416100W00	732	T418910W00	666	T42006ELPTN00	701	T42017WFLN00	707	T430310N00	624
T4062ELPTW00	699	T4084WFLW00	700	T4110ELPTN00	722	T416700W00	821	T418910W10	666	T42006ELPTW00	701	T42017WFLW00	707	T430310W00	624
T4062FLN00	699	T4085ELPTN00	700	T4110ELPTW00	722	T416800W00	820	T418939N00	666	T42006NSPN00	701	T42018ELPTN00	707	T430325N00	624
T4062FLW00	699	T4085ELPTW00	700	T4110NSPN00	722	T416900W00	820	T418939N10	666	T42006NSPW00	701	T42018ELPTW00	707	T430325W00	624
T4062SPN00	699	T4085NSPN00	700	T4110NSPW00	722	T417000W00	821	T418939W00	666	T42006WFLN00	701	T42018NSPN00	707	T4303ELN00	624
T4062SPW00	699	T4085NSPW00	700	T4110WFLN00	722	T417100W00	812	T418939W10	666	T42006WFLW00	701	T42018NSPW00	707	T4303ELW00	624
T4063ELPTN00	699	T4085WFLN00	700	T4110WFLW00	722	T417200W00	812	T4189ELN00	666	T42007ELPTN00	702	T42018WFLN00	707	T430418N10	676
T4063FLN00	699	T4085WFLW00	700	T4111ELPTN00	723	T417300W00	812	T4189ELN10	666	T42007ELPTW00	702	T42018WFLW00	707	T430418N20	676
T4063FLW00	699	T4086ELPTN00	702	T4111ELPTW00	723	T417400N00	744	T4189ELW00	666	T42007NSPN00	702	T42019ELPTN00	708	T430418W10	676
T4063FLW00	699	T4086ELPTW00	702	T4111NSPN00	723	T417400W00	744	T4189ELW10	666	T42007NSPW00	702	T42019ELPTW00	708	T430418W20	676
T4063SPN00	699	T4086NSPN00	702	T4111NSPW00	723	T417500N00	749	T4190NLN00	769	T42007WFLN00	702	T42019NSPN00	708	T430434N10	676
T4063SPW00	699	T4086NSPW00	702	T4111WFLN00	723	T417500W00	749	T4190NLN10	769	T42007WFLW00	702	T42019NSPW00	708	T430434N20	676
T4064ELPTN00	701	T4086WFLN00	702	T4111WFLW00	723	T417600N00	744	T4190NLN10	769	T42008ELPTN00	703	T42019NSPW00	708	T430434W10	676
T4064ELPTW00	701	T4086WFLW00	702	T4114ELPTN00	724	T417600W00	744	T4190NLW10	769	T42008ELPTW00	703	T42019WFLN00	708	T430434W20	676
T4064NSPN00	701	T4087ELPTN00	702	T4114ELPTW00	724	T417700N00	749	T41911N00	766	T42008NSPN00	703	T42019WFLW00	708	T430518N10	676
T4064NSPW00	701	T4087ELPTW00	702	T4114NSPN00	724	T417700W00	749	T41911N10	766	T42008NSPW00	703	T42019NLN10	762	T430518N20	676
T4064WFLN00	701	T4087NSPN00	702	T4114NSPW00	724	T417800N00	744	T41911NW00	766	T42008WFLN00	703	T42019NLW00	762	T430518W10	676
T4064WFLW00	701	T4087NSPW00	702	T4114WFLN00	724	T417800W00	744	T41911NW10	766	T42008WFLW00	703	T42019NLW10	762	T430518W20	676
T4065ELPTN00	701	T4087WFLN00	702	T4114WFLW00	724	T417900N00	749	T41922N00	766	T42009ELPTN00	696	T42020ELPTN00	708	T430534N10	676
T4065ELPTW00	701	T4087WFLW00	702	T4120ELPTN00	707	T417900W00	749	T41922N10	766	T42009ELPTW00	696	T42020ELPTW00	708	T430534N20	676
T4065NSPN00	701	T4092ELPTN00	704	T4120ELPTW00	707	T418010N00	686	T41922N10	766	T42009NSPN00	696	T42020NSPN00	708	T430534W10	676
T4065NSPW00	701	T4092ELPTW00	704	T4120NSPN00	707	T418010N10	686	T41922N10	766	T42009SPW00	696	T42020NSPW00	708	T430534W20	676
T4065WFLN00	701	T4092NSPN00	704	T4120NSPW00	707	T418010W00	686	T41931LN00	767	T42009WFLN00	696	T42020WFLN00	708	T430600010	676
T4065WFLW00	703	T4092NSPW00	704	T4120WFLN00	707	T418010W10	686	T41931LN10	767	T42009WFLW00	696	T42020WFLW00	708	T430600020	676
T4066ELPTN00	703	T4092WFLN00	704	T4120WFLW00	707	T418039N00	686	T41931LW00	767	T42010ELPTN00	697	T42021LN00	762	T430700000	676
T4066ELPTW00	703	T4092WFLW00	704	T4121ELPTN00	708	T418039N10	686	T41931LW10	767	T42010ELPTW00	697	T42021LN10	762	T430801	624
T4066NSPN00	703	T4093ELPTN00	704	T4121ELPTW00	708	T418039W00	686	T41931LW10	767	T42010ELPTW00	697	T42021LN10	762	T430802	624
T4066NSPW00	703	T4093ELPTW00	704	T4121NSPN00	708	T418039W10	686	T41941NN00	766	T42010SPN00	697	T42021LW00	762	T430803	624
T4066WFLN00	703	T4093NSPN00	704	T4121NSPW00	708	T4180ELN00	686	T41941NN10	766	T42010SPW00	697	T42021LW10	762	T430804	624
T4066WFLW00	703	T4093NSPW00	704	T4121WFLN00	708	T4180ELN10	686	T41941NW00	766	T42010WFLN00	697	T42021NN00	762	T430804	624
T4067ELPTN00	703	T4093WFLN00	704	T4121WFLW00	708	T4180ELN10	686	T41941NW10	766	T42010WFLW00	697	T42021NN10	762	T440000W00	789
T4067ELPTW00	703	T4093WFLW00	704	T4124ELPTN00	709	T4180ELW00	686	T41952N00	766	T42011ELPTN00	698	T42021NNW00	762	T440000W00	789
T4067NSPN00	703	T40991	720	T4124ELPTW00	709	T41810N00	687	T41952N10	766	T42011ELPTW00	698	T42021NNW10	762	T7633ELPTN00	663
T4067NSPW00	703	T409902	720	T4124NSPN00	709	T41810N10	687	T41952N10	766	T42011FLN00	698	T42021NN10	762	T7633ELPTW00	663
T4067WFLN00	703	T409903	730	T4124NSPW00	709	T418110N00	687	T41952N10	766	T42011FLW00	698	T42021NN10	762	T7633FLN00	663
T4067WFLW00	703	T409903	719	T4124WFLN00	709	T418110W00	687	T41961LN00	767	T42011SPN00	698	T42021LW00	763	T7633FLW00	663
T4072ELPTN00	704	T409904	719	T4124WFLW00	709	T418110W10	687	T41961LN10	767	T42011SPW00	698	T42021LW10	763	T7633SPW00	663
T4072ELPTW00	704	T409905	731	T4124WFLW00	709	T418139N00	687	T41961LW00	767	T42012ELPTN00	699	T42021LW10	763	T7633SPW00	663
T4072NSPN00	704	T409905	718	T4130ELPTN00	707	T418139N10	687	T41961LW10	767	T42012ELPTW00	699	T42021LW10	763	T7633SPW00	663
T4072NSPW00	704	T409906	718	T4130ELPTW00	707	T418139W00	687	T419700W00	789	T42012FLN00	699	T42021LW10	763	T7633SPW00	663
T4072WFLN00	704	T409907	730	T4130NSPN00	707	T418139W10	687	T419800N00	855	T42012FLW00	699	T42021LW10	763	T7633SPW00	663
T4072WFLW00	704	T409907	730	T4130NSPW00	707	T4181ELN00	687	T419800N00	855	T42012FLW00	699	T42021LW10	763	T7633SPW00	663
T4073ELPTN00	7														

ASIA - OCEANIA

Headquarters

Artemide S.p.A.
Via Bergamo, 18
20010 Pregnana Milanese (MI), Italy
Tel. +39 02 93518.1 - 93526.1
Numero verde 800 834 093
(from Italy only)
info@artemide.com
www.artemide.com

Communication and Marketing Department

Via Canova, 34
20145 Milan (MI), Italy
Tel. +39 02.349611
communication@artemide.com
www.artemide.com

Architectural division

Artemide Architectural S.A.S.
Z.I. du Breuil
18400 Saint Florent sur Cher, France
Tel. +33 02 48 23 99 00

Australia

Head office and Showroom:
Adelaide
Ornare Imports Pty. Ltd.
28 Fullarton Rd, Norwood SA 5067
Tel. +61 08 8362 3029
info@artemide.com.au
www.artemide.com.au

Office and Showrooms:

Sydney
504-508 Cleveland St
Surry Hills NSW 2010
Tel. +61 02 9699 8472
sydney@artemide.com.au

Melbourne

46-48 Rayhdowne St
Carlton VIC 3053
Tel. +61 03 9349 3310
melbourne@artemide.com.au

China

Head office:
Artemide Trading
(Shanghai) Co., Ltd.
Room 1907, 19/F, New Hualian
Mansion, East Wing, 755 Middle Huai
Hai Road, Huang Pu District, Shanghai
Tel. +86 21 6448 3650
info@artemide.cn

Affiliated Showrooms:

Beijing
Unit B245, Cofco Plaza,
No. 8 Jianguomennei Street,
Dongcheng District, Beijing
Tel. +86 10 8511 8718

Unit 1-B-20, International Furniture
Hall, Easy Home, No. 65 North 4th
Ring Road, Chaoyang District, Beijing
Tel. +86 10 8463 6098

Hong Kong and Macao

Head Office:
Artemide Ltd.
Unit 1303, 13/F, Ruttonjee House
Ruttonjee Centre, 11 Duddell Street
Central, Hong Kong
Tel. +852 2523 0050
info@artemide.com.hk

Showroom:

Shop 102-103, Ruttonjee Centre,
11 Duddell Street, Central, Hong Kong
Tel. +852 2523 0333

India

Head office:
Artemide Lighting India Pvt. Ltd.
Unit no 5, 2nd floor
Raghuvanshi Mansion
Raghuvanshi Mills Compound
Senapati Bapat Marg, lower parel
Maharashtra, Mumbai 400013
Tel. +91 22 61774800
info@artemide.in

Indonesia

Representative Office:
Artemide Ltd.
Tel. +852 2523 0050
info@artemide.com.hk

Japan

Head office:
Artemide Japan K.K.
#2013 1-41-7 Tomigaya Shibuya-ku,
151-0063 Tokyo Japan
Tel. +81 3 5738 7410
info@artemide.co.jp

Malaysia

Distributor:
Lightcraft (KL) Sdn Bhd
145-5&6, Jalan Sungai Besi,
57100 Kuala Lumpur, Malaysia
Tel. +603 9222 4219
info@lightcraft.com.my

New Zealand

Distributor:
ECC Lighting
39 Nugent Street, Grafton, Auckland PO
Box 391, Auckland 1140
Tel. +64 9 379 9680
info@ecc.co.nz

Philippines

Representative Office:
Artemide Ltd.
Tel. +852 2523 0050
info@artemide.com.hk

Singapore

Distributor:
Million Lighting Co Pte Ltd
203 Kallang Bahru, Singapore 339340
Tel. +65 6743 2033
enquiry@millionlighting.com

South Korea

Distributor:
Duomo & Co.
727, Nonhyun-ro, Gangnam-gu
Seoul, Korea
Tel. +82 2 512 5828

Thailand

Representative Office:
Artemide Ltd.
Tel. +852 2523 0050
info@artemide.com.hk

Taiwan

Distributor:
Bravocasa Co., Ltd.
3F, No. 8 Chongqing Road
Banqiao Dist., New Taipei City 220
Taiwan (R.O.C.)
Tel. +886 2 2963 0229
sonya@bravocasa.com.tw
www.bravocasa.com.tw

Vietnam

Distributor:
Cao Tran Co., Ltd
23 Tran Phu, P.4-Q.5
Ho Chi Minh City, Vietnam
Tel. 84.8 3833 3334
Fax: 84.8 3833 3337
caotran@cara.com.vn
www.cara.com.vn

AFRICA

Angola

Representative Office:
Artemide Middle East
info@artemide.ae

Egypt

Representative Office:
Artemide Middle East
info@artemide.ae

Morocco

Distributor:
Arrakis Sarl, Villa N° 4 Rue Oum
Kaltoum 20 000 Casablanca
Tel. +212 (0) 522949947
contact@arrakis-lighting.com

Nigeria

Representative Office:
Artemide Middle East
info@artemide.ae

South Africa

Representative Office:
Artemide Middle East
info@artemide.ae

Tunisia:

Representative Office:
Artemide Middle East
info@artemide.ae

EUROPE

Albania

Principal dealer:
A Bi Esse
Superstrada Tirane-Durres km 6
Yrshek, Tirane
Tel. +355 48 200416
info@abiesse.al

Austria

Head office and Showroom:
Artemide Handelsgesellschaft mbH
Gonzagagasse 1 / Morzinplatz
1010 Wien
Tel. +43 01 803 21 82
info@artemide.at

Azerbaijan

Principal dealer:
Studio 151
Port Baku Residence
Uzeyir Hacıbəyov str. 151, 1001 Baku
Tel. +994 12 599 2040/41
studio151@office.az

Benelux (Belgium/Holland/Luxemburg)

Head office: Horas S.A.
Beemdstraat 25
1601 Ruisbroek, Belgium
Tel. +32 02 334 84 50
artemide_benelux@artemide.com

Brussels showroom and Lighting
Consultancy Center:
Chaussée de Waterloo 410
1050 Brussels - Belgium
Tel. +32 02 534 03 67
artemide.brussels@skynet.be

Amsterdam showroom and Lighting
Consultancy Center:
Hobbemakade 89,
1071 XR Amsterdam Holland
Tel. +31 20 4702668
artemide.amsterdam@artemide.nl

Bosnia and Herzegovina

Representative Office:
Artemide S.p.A.
Via Bergamo, 18
Tel. +39 02 93518.1 - 93526.1
info@artemide.com

Bulgaria

Representative Office:
Artemide S.p.A.
Via Bergamo, 18
Tel. +39 02 93518.1 - 93526.1
info@artemide.com

Czech Republic

Principal dealer:
Selene spol. s.r.o.
Neumannova 161, 383 01 Prachatice
Tel. +420 388 310 326
selene@iol.cz

Showroom:
Komunardu 32
Holesovice 17000 Praha 7

Showroom:
Sazavska 32
Vinohrady 120 000 Praha 2
Romania

Cyprus

Representative Office:
Artemide S.p.A.
Via Bergamo, 18
Tel. +39 02 93518.1 - 93526.1
info@artemide.com

Croatia

Representative Office:
Artemide S.p.A.
Via Bergamo, 18
Tel. +39 02 93518.1 - 93526.1
info@artemide.com

Estonia

Principal dealer
Laterna Magica
Kreutzwaldi 8, 10124 Tallin
Tel. +372 6466 994
info@laterna.ee

France

Head Office and Showroom:
Artemide France S.A.S.
52, avenue Daumesnil, 75012 Paris
Tel. +33 01 43 44 44 44
artemide@artemide.fr

Germany

Head office and Showroom:
Artemide GmbH
Hans-Böckler-Straße 2
58730 Fröndenberg
Tel. +49 02373 975.0
info@artemide.de

München Office:
Luise-Ullrich-Straße 20, 80636 München
Tel. +49 089/70065198
muenchen@artemide.de

Frankfurt Showroom:
Baseler Straße 10, 60329 Frankfurt
Tel. +49 069 3399 5690
frankfurt@artemide.de

Greece

Head office:
Artemide Hellas S.A.
34,Solonos St.
106 73 Athens
Tel. +30 210 3646770
e-mail: info@artemide.gr

North Greece Branch Offices & Showroom

92, G. Papandreou St.
546 65 Thessaloniki
Tel. +30 2310 403934
e-mail: thessaloniki@artemide.gr

Hungary

Representative Office:
Artemide Austria
Tel. +43 (0) 1 803 21 82-0
info@artemide.at

Ireland

Artemide GB Ltd.
Tel. +44 (0) 20/7631 5200
info@artemide.co.uk

Italy

Head office:
Artemide Italia s.r.l.
Via Bergamo 18
20010 Pregnana Milanese (MI)
Tel. +39 02 93518.1 - 93526.1
Numero Verde 800 834 093
info@artemide.com

Milano Lighting Consultancy Center:

Via Manzoni 12, 20121 Milano
Tel. +39 02 778712201 - 78712202
manzoni@artemide.com

Roma Lighting Consultancy Center:

Via Pisanelli 1, 00196 Roma
Tel. +39 06 94537550
pisanelli@artemide.com

Milano Monforte Showroom:

Corso Monforte 19, 20122 Milano
Tel. +39 02 76006930 - 794039
monforte@artemide.com

Milano Manzoni Showroom:

Via Manzoni 12, 20121 Milano
Tel. +39 02 778712201 - 78712202
manzoni@artemide.com

Milano Danese Showroom:

Piazza San Nazaro in Brolo 15,
20122 Milano
Tel. +39 02 58304150
showroomdanese@artemide.com

Roma Margutta Showroom:

Via Margutta 107, 00187 Roma
Tel. +39 06 36001802 - 36001808
margutta@artemide.com

Kosovo

Principal dealer:
Light House Studio
Veternik nn, 1000 Prishtine
Tel. +386 (0) 43 733 333
info@lighthouse-kos.com

Latvia

Principal dealer
Trentini Group
Lacplesa iela 101, 1011 Riga
Tel. +371 678 70890
info@artemide.lv

Lithuania

Principal dealer
Delight LT UAB, Vytenyo 13
03112 Lituania
Tel. +370 5 2104218
info@delight.lt

Malta

Representative Office:
Artemide Italia s.r.l.
Tel. +39 02 93518.1 - 93526.1
info@artemide.com

Montenegro

Principal dealer:
Artefacto + Design Center
Bulevar Svetog Petra Cetinjskog, Ulica 2
81000 Podgorica
Tel. +382 20 220-597
info@artefactoplus.me

Poland

Head Office:
Artemide Dystrybucja Polska sp. z o.o.
Ul. Saperow 4, 82-300 Elblag
Tel. +48 55 236 11 85
info@liralighting.pl

Showroom:

Ul. Rydygiera 8, Warsaw

Portugal

Head office and Showroom:
Foton Iluminação Ltda
Rua da Garagem 3
2794-021 Carnaxide
Tel. +351 21 416-90-70
geral@foton.pt

Romania

Principal dealer:
Helios pls
Heliade intre Vii, nr 8, Etaj 2
023383 Bucarest

Russia

Head office:
Artemide Agency OOO
Bolshoj Zlatoustinskij Pereulok, Bldg
1, office 100, 101000 Moscow
Tel. +7 495 984 2238
info@artemide-agency.ru

Scandinavia

Head office & Showroom:
Artemide Scandinavia A/S
Skudehavnsvej 5 D-2100 Copenhagen,
Denmark
Tel. +45 (0) 7020 1700
info@artemide.dk

Serbia

Representative Office:
Artemide S.p.A.
Via Bergamo, 18
Tel. +39 02 93518.1 - 93526.1
info@artemide.com

Slovakia

Principal dealer:
AKL s.r.o.
Vietnamská 45, 82104 Bratislava
Tel. +421 (0) 907 767 008
info@aklsro.sk

Slovenia

Principal dealer:
ARCADIA
Šmartinska 152 / hala E, 1000 Ljubljana
Tel. +386 (0) 1 423 30 25
Tel. +386 (0) 1 423 40 25
info@arcadia-svetila.si

Spain

Head office:
Artemide S.A.
C/Vico, 12-18 bajos, 08021 Barcelona
Tel. +34 093 478 3911
artemide@artemide.es

Switzerland

Head office and Showroom:
Artemide Illuminazione S.A.
Bärenegasse 16, 8001 Zürich
Tel. +41 043 268 2727
info@artemide.ch

Turkey

Office and showroom:
Oztas Aydinlatma
Yskender Cad. ,24
34420 Istanbul - Sishane
Tel. +90 212 237 52 36
info@oztasaydinlatma.com

United Kingdom

**Head office, Showroom and
Lighting Consultancy Center:**
Artemide GB Ltd.
106 Great Russell Street,
London WC1B 3NB
Tel. +44 (0) 20/7631 5200
info@artemide.co.uk

LATIN AMERICA

Argentina

Distributor:
Head Office & Showroom:
Edimetra S.A.
Paraguay 792 3° Piso
1057 Buenos Aires
Tel. +54 11 4312-2590
info@artemide.com.ar

Bolivia

Showroom:
Studio Tessuto
Local 103 - Urubó Business Center
Santa Cruz - Bolivia
Tel: +591 3 321 6313
info@studiotessuto.com

Brasil

Distributor:
Head Office & Showroom:
Cynthron
Rua do Rócio, 423 - 18° andar,
Vila Olimpia
04552 000 - São Paulo - SP
Tel. +55 11 3846-8100
cynthron@cynthron.com.br

Chile

Showroom:
Interdesign
Isidora Goyenechea 3200
Las Condes, Santiago
Tel. 56-2 22314114
info@interdesign.cl

Dominican Republic

Distributor:
Head Office & Showroom
Spazio di Casa
Ave. Max Henriquez Ureña No.17
Ensanche Naco, Santo Domingo
Tel. +1 809.368.2001
info@spaziodicasa.com

Mexico

Distributor:
**Head Office, Showroom &
Customer Service**
Scultura Luminosa
Suderman #246, Col. Chapultepec
Morales
Mexico D.F. 11570
Tel. +52 55 5250 2661
info@artemide.mx

Panama

Showrooms:
Idea Design Center
Av. Samuel Lewis con Calle 59
Kenex plaza, Obarrio, Panama city,
Rep. de Panama
Tel. +507 216.90.67
info@ideapanama.com

Lumicentro

Ave. Justo Arosemena, Esquina Calle 33
Ave. Ecuador. Edificio Lumicentro
Apartado 0816-01064
Panama City - Rep. de Panama
Tel. +507 300 2400
info@lumicentro.com

Peru

Showroom:
Hilite
Av. Conquistadores 575
San Isidro - Peru'
Tel. +511 422 9123
proyectos@hiliteperu.com

Uruguay

Showroom:
TRIOS Lighting
Luis de la Torre 593b
Montevideo - Uruguay
Tel. +598 2711 9260
info@trioslighting.com

Venezuela

Showroom:
Iluminación HELIOS
Av. San Felipe, Centro Coinasa, Mezzanina
La Castellana, Caracas. 1060 - Venezuela
Tel. +58-212 265.58.83
informacion@helios.com.ve

For information regarding distributors and points of sale for Latin American countries not listed above, please email:
infolatam@artemide.net.

MIDDLE EAST

Bahrain

Representative Office:
Artemide Middle East
info@artemide.ae

Iran

Representative Office:
Artemide Middle East
info@artemide.ae

Jordan

Representative Office:
Artemide Middle East
info@artemide.ae

Kuwait

Representative Office:
Artemide Middle East
info@artemide.ae

Lebanon

Representative Office:
Artemide Middle East
info@artemide.ae

Oman

Representative Office:
Artemide Middle East
info@artemide.ae

Qatar

Representative Office:
Artemide Middle East
info@artemide.ae

Saudi Arabia

Representative Office:
Artemide Middle East
info@artemide.ae

Syria

Representative Office
Artemide Middle East Dubai
Tel. +971 4 887 2022
info@artemide.ae

United Arab Emirates

Head office & Showroom:
Artemide Middle-East
Dubai Design District (D3)
Building 6 - 3rd Floor - Offices A307
Dubai, UAE
info@artemide.ae

NORTH AMERICA

Canada

Head office:
Artemide Ltée/Ltd.
11105 rue Renaude Lapointe
Montréal, Québec H1J 2T4
Tel. +1 514 323 6537
Toll free +1 888 777 2783
infocanada@artemide.net
www.artemide.net

Showroom:

Toronto
5 Mill Street
Toronto, Ontario M5A 3R6
Tel. +1 416 628 6718
toronto@artemide.net

Sales office:

Montréal
Tel. +1 514 788 3788
montreal@artemide.net

U.S.A.

Headquarters

Artemide, Inc.
250 Karin Lane
Hicksville, NY 11801
Tel. +1 631 694 9292
Toll free +1 877 Art 9111
infousa@artemide.net
www.artemide.net

Showrooms:

Chicago, IL
351 W Hubbard street, #103
Chicago, IL 60654
Tel. +1 312 475 0100
chicago@artemide.net

Los Angeles, CA

9006 Beverly Blvd.
West Hollywood, CA 90048
Tel. +1 310 888 4099
losangeles@artemide.net

Miami, FL

2222 Ponce de Leon Boulevard
Coral Gables, FL 33134
Tel. +1 305 444 5800
miami@artemide.net

New York, NY

46 Greene Street
New York, NY 10013
Tel. +1 212 925 1588
newyork@artemide.net

Sales offices:

Dallas, TX

Tel. +1 214 747 8344
dallas@artemide.net

Philadelphia, PA

Tel. +1 215 733 9877
philadelphia@artemide.net

San Francisco, CA

Tel. +1 415 393 9955
sanfrancisco@artemide.net

© Artemide S.p.A.

Art direction & editing
Studio de Bevilacqua
Carlotta de Bevilacqua
with
Ippolita Ciampini
Diego Martinelli

Artemide Research & Innovation
Fabio Zanola

Image editing
and 3D visualization
Paola Monaco di Arianello
Simone Fantoni
Alessandro Peccati

Still lifes
Jean Pierre Maurer
Manuel Maurer
Gio Pini
Federico Villa
Miro Zagnoli

Prepress
Actualtype s.r.l.

Press
Rotolito Lombarda
June 2015



Compasso D'oro
1967-1989-1994-2004



Winner European
Design Prize '97



ISO 9001:2008



ISO 14001:2004



BILAN CARBONE®



CTF STAGE2
ISO 17025